

# BUS

Wired electro-installation





**ELKO EP**

**We have been your partner in the field for 30 years,  
manufacturing and developing the highest quality  
electrical devices.**

ELKO EP employs 330 people across 15 foreign branches that exports its products to more than seventy countries. Company of the Year of the Zlín Region, Visionary of the Year and Global Exporter of the Year are just some of the awards we have received throughout the years as we consistently strive to move forward in the field of innovation and development.

Millions of relays, hundreds of smart homes and thousands of satisfied customers. This is ELKO EP; a traditional company based in the center of Europe, where development, production, logistics, and service are at the forefront of our focus. Building automation systems, smart city facilities and the Internet of Things (IoT) devices are solutions we can offer.

# Facts and stats



**35 %**  
Czech

**40 %**  
Export

**25 %**  
Branches

**330**  
Employees

**15 000**  
iNELS  
installation

**12 000 000**  
Manufactured  
products



**10**  
Branches

**6**  
Franchises

**70**  
Exporting  
countries



**World leader**  
in production of relays



**WE ARE**



## DEVELOPERS

In the new R&D centre, more than 30 engineers develop new products and extend the functionality of existing product.

## PRODUCERS

Modern antistatic spaces, 2 × fully automated SMD production lines with 2 shift operations.

## SUPPORT

24 hours / 7 days / 360 days we not only provide technical support but also logistics.

## SELLERS

Personal access to more than 70 sales representatives in ELKO EP Holding providing impeccable services and superior products at an affordable price.

## Smart electro-installations

iNELS IP - New IP topology .....	7
Overview of system units .....	10

### Central units

CU3-07M   Basic central unit for iNELS BUS control - <b>NEW!</b> .....	16
CU3-08M   Extended central unit for iNELS BUS control - <b>NEW!</b> .....	17
CU3-IPMaster   Superior central unit for project management using the iNELS IP protocol - <b>NEW!</b> .....	18
CU3-09M-DALI   Central unit for controlling DALI ballast - <b>COMING SOON!</b> .....	19

### System units

PS3-30/iNELS   Power supply with bus separato - <b>NEW!</b> .....	22
BPS3-01M, BPS3-02M   Bus separator from power supply .....	23
PS3-100/iNELS   Power supply .....	24

### Lighting control

EMDC-64M   Converter iNELS EBM - DALI/DMX .....	28
DMD3-1   Combined motion, temperature, humidity and intensity detector .....	29
DLS3-1   Light intensity sensor .....	30

### Converters

ADC3-60M   Analog-to-digital converter, 6 input .....	32
DAC3-04M   Digital-to-analog converter, 4 input .....	33

### Roller shutter actuators

JA3-02B/DC   Roller shutter (blind) actuator, 2 channels (1 controller) .....	36
JA3-018M   Roller shutter (blind) actuator, 18 channels (9 controllers) .....	37

### Switching actuators

SA3-01B, SA3-02B   Switching actuator, 1 channel and 2 channels .....	40
SA3-04M   Switching actuator, 4 channels .....	41
SA3-06M   Switching actuator, 6 channel .....	42
SA3-012M   Switching actuator, 12 channels .....	43
SA3-022M   Switching actuator, 22 channels .....	44
EA3-022M   Switching actuator without controls and indicators, 22 channels .....	45

### Dimming actuators

DA3-22M   Universal dimming actuator, 2 channels .....	48
DA3-66M   Dimming actuator, 6 channels - <b>NEW!</b> .....	49
LBC3-02M   Dimming actuator for ballasts, 2 channels .....	50

### Input units

IM3-40B, IM3-80B   Binary input units, 4 channels and 8 channels .....	52
TI3-40B   Temperature input, 4 channels .....	54
TI3-60M   Temperature input, 6 channels .....	55
IM3-140M   Binary input unit, 14 channels .....	56

### Combined units

RC3-610M/DALI   Room controller with DALI dimmer - <b>COMING SOON!</b> .....	58
--	----

RC3-612M   Room controller with PHASE dimmers - <b>COMING SOON!</b>	59
FA3-612M   Special unit for controlling fan coils	60
IOU3-108M   Universal unit with inputs and outputs, 10 inputs and 8 outputs - <b>NEW!</b>	61

**Wall units and controllers**

EST3   Touchscreen control unit	64
GSB3-40, GSB3-60, GSB3-80   Wall-mounted glass touch controls	66
WSB3-20, WSB3-20H   Wall controller, 2 buttons	68
WSB3-40, WSB3-40H   Wall controller, 4 buttons	69
WMR3-21   Wall-mounted card reader	70
GMR3-61   Wall-mounted glass card reader	71
IDRT3-1   Digital room thermoregulator	72

**Hotel units**

GCR3-11   Glass card reader	74
GDB3-10   Glass room door bell (info panel)	75
GCH3-31   Glass card holder reader	76
EHT3   Hotel control unit with touch screen	77
GRT3-50   Glass room thermoregulator	78
GBP3-60   Glass panel	79
GBP3-60   Accessories	80
GSB3-20/S, GSB3-40/S, GSB3-60/S   Glass touch controls with symbol	82
GSP3-100   Glass touch panel	84

**Integration**

Integration of iNELS into the Building Management Systems (BMS)	86
Home Assistant GW   Third-party integration server, iNELS IP protocol	89
Connection Server   Third-party integration server	90
eLAN-IR-003   Ethernet-IR converter	91
eLAN-RS485/232   Converter RS485/232-iNELS	92

**Multimédia**

LARA Radio	94
LARA Intercom	95
LARA accessories	97

**iNELS application: "ALL in ONE"**

	98
--	----

**Accessories iNELS**

TELVA-2 230V, TELVA-2 24V   Termo-drive	102
TC, TZ, Pt100   Temperature sensors	103
Bus wiring	104
Load capacity of products	105
Assembly	108
Product dimensions	110

**Evolutionary change in the structure of the connection to the collection system and iNELS BUS, it is only possible to use the IP protocol to connect individual central units and the collection points connected to them. The new IP infrastructure brings about the full potential of using collection points in small, medium and very large installations.**

## **Autonomous BUS**

Compared to the previous version of iNELS BUS, where all buses were connected via EBM to one central unit, in the new structure each bus is fully autonomous thanks to a mini-fictitious version of the central unit (CU3-07/08M). MiniCU (short name for single-modular central unit) is a full-fledged central unit that controls only 1 or 2 buses. The fundamental difference is to maintain full functionality even in the event of loss of communication with other units so that all units connected to the miniCU remain in the interdicted, including all predefined links. When the connection with the over-the-top drives is restored, the centrally controlled functions are synchronized and restored.

Centrally controlled installation allows interconnection of all end devices. However, the functionality of the individual parts of the project is not affected in the event of any failure of the central control, because the minimized central unit CU3-07/08M ensures complete functionality of the connected buses.

## **One central unit even for very large installations**

Centrally controlled functionalities are provided by the superior central unit CU3-IPMASTER. The "IP master" clearly defines how this central unit is connected to the autonomous MiniCU using the IP protocol. With a commonly used Ethernet speed of 100Mbps and the possibility of asynchronous communication, the connection capacity between the IPMASTER unit and the subordinate miniCUs (CU3-07M/08M) is more than 1,000 times greater than in the previous version of iNELS BUS. Thanks to this, we can connect IPMASTER with a larger number of subordinate buses at the same time.

The interconnection of miniCUs controlling individual buses with the IP Master control unit using a standard IP protocol significantly expands the possible scope of the project. In addition to the multiply higher capacity of the transferred data, it is possible to connect geographically remote parts of the installation into a single, centrally controlled project using common network tools.

## **Fully autonomous installation**

Thanks to the high performance of the IPMASTER unit, we can control even extensive installations with only one IPMASTER unit. Unlike similar solutions, where the IP protocol in large installations is mainly used for interconnection with an external system based on cloud technologies, the IPMASTER unit guarantees full functionality without the need for an Internet connection. For fully functional operation of a large installation, it is only necessary to ensure mutual connectivity with subordinate MiniCU.

Even without an Internet connection, thanks to CU3-IPMASTER, the installation is fully functional, including the fine interconnection of individual buses and the user's favorite control via the iNELS application, switched to local mode.

## **Central monitoring and global interconnection**

The new IP infrastructure consists not only in the connection between the MiniCU and the central IP-MASTER unit, but also in the connection to the central iNELS CLOUD system, which allows to connect individual projects into functional units. You can use global linking to link projects so that, based on information or actions in a single system, you can use global conditions to initiate actions in other linked projects. iNELS CLOUD also offers the possibility of creating conditions linked to external third-party systems or global time and meteorological variables. Thanks to the centralized topology of the iNELS IP environment, iNELS CLOUD is also a powerful tool for checking all connected projects, system units and end devices. At the same time, the central monitoring performs the function of a backup environment for all system units, so that backups can be used for quick project recovery if necessary.

Event-based conditionality in a geographically remote project allows you to automatically manage or manage buildings in different locations or objects in large campuses. Central supervision can be used by service partners for independent control of all units and equipment.

## **iNELS portfolio compatibility**

The new iNELS IP communication platform will be standard for all new system units in the Entire Portfolio iNELS. V iNELS IP Topology so it is possible to exploit Central CU3 units for the management of iNELS BUS end devices, as well as eLAN system units for control Wireless Elements iNELS RF or New System Unit for Integration third-party iNELS Home Assistant. With IPMASTER units, almost the entire portfolio iNELS including device Third Parties pluggable via opened platform Home Assistant.

Full compatibility of all system units, complemented by an open Home Assistant platform, allows the interconnection of the entire iNELS portfolio with third-party end devices (implemented in the Home Assistant platform) without the need for programming or complicated setup.

## **Integration openness of iNELS IP**

Thanks to New Tool iNELS IDE Kit there is an open path for Integration Superior's system themes, Communicating via BACNET or MODBUS Protocols. Exploitation of the entire iNELS portfolio v integrations for BMS (Building Management Systems) so becoming much simpler and communicatively compatible with the usually used standard protocols.

The iNELS IP environment can be a great competitive advantage for partner solutions where it is necessary to integrate or implement devices and elements from the iNELS portfolio into existing systems or platforms. Therefore, the iNELS IP protocol is available for partners who are interested in integrating the iNELS portfolio into their solutions. With the help of a unified protocol, partners are thus opened up to compatibility with all system units, even with newly developed or planned ones.

APPLICATION

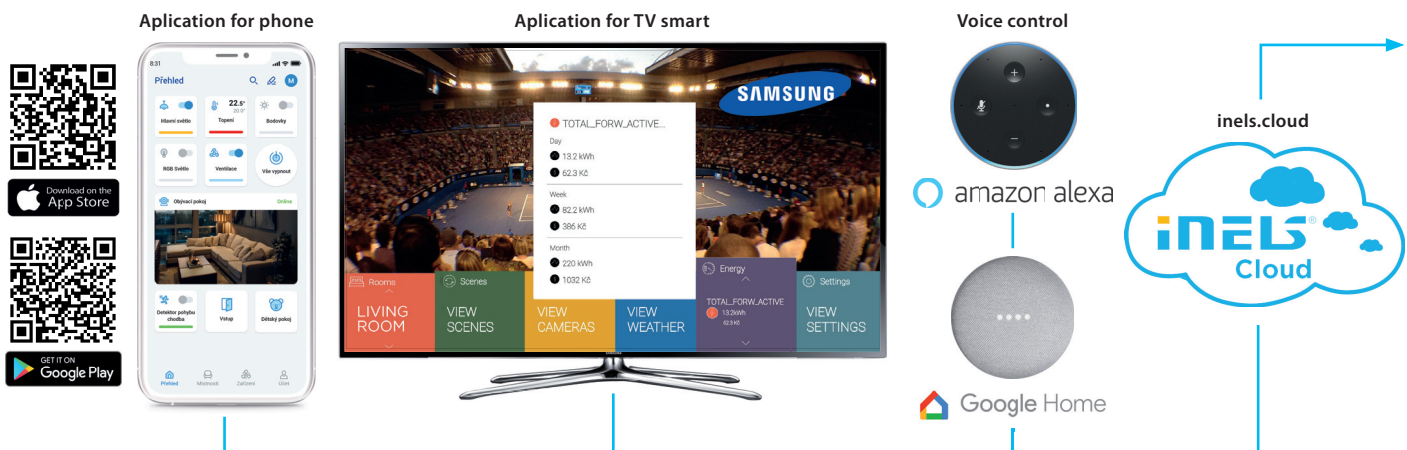

BUS 1 MODBUS  
CU3-07M

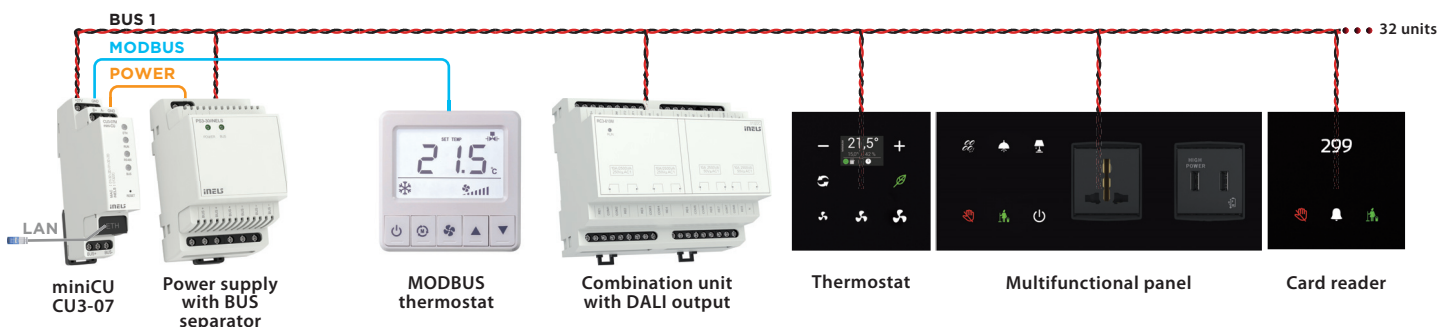

BUS 1  
BUS 2  
CU3-08M

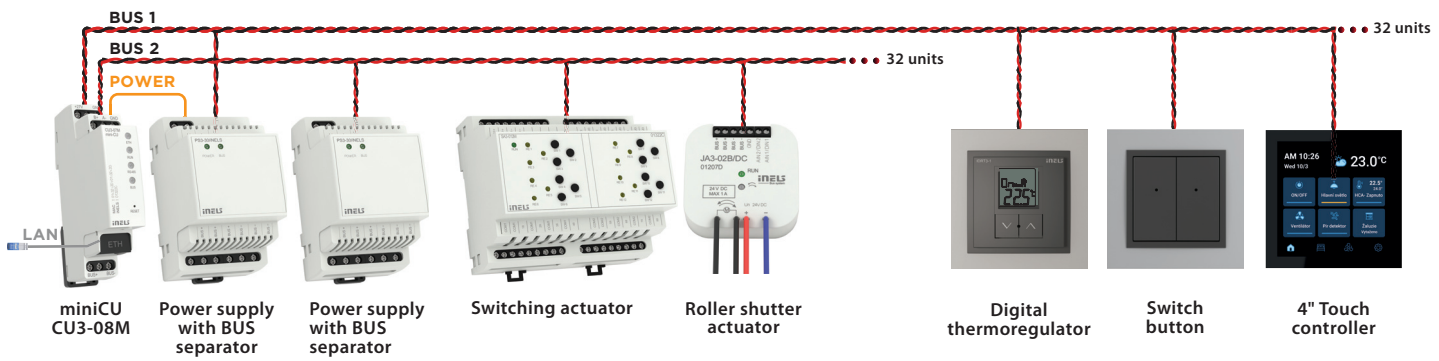

BUS 1 DALI  
CU3-09M/DALI

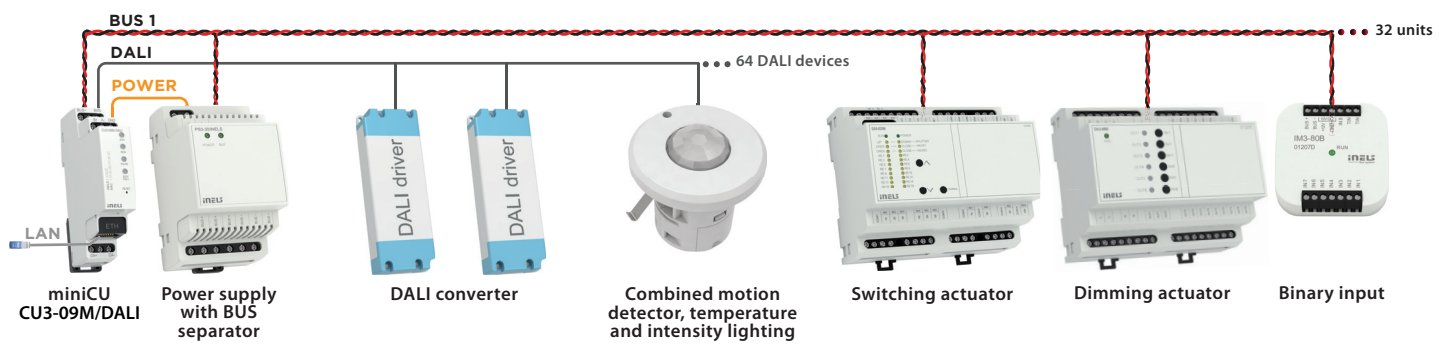

RADIO 868 Mhz  
eLAN-RF-104





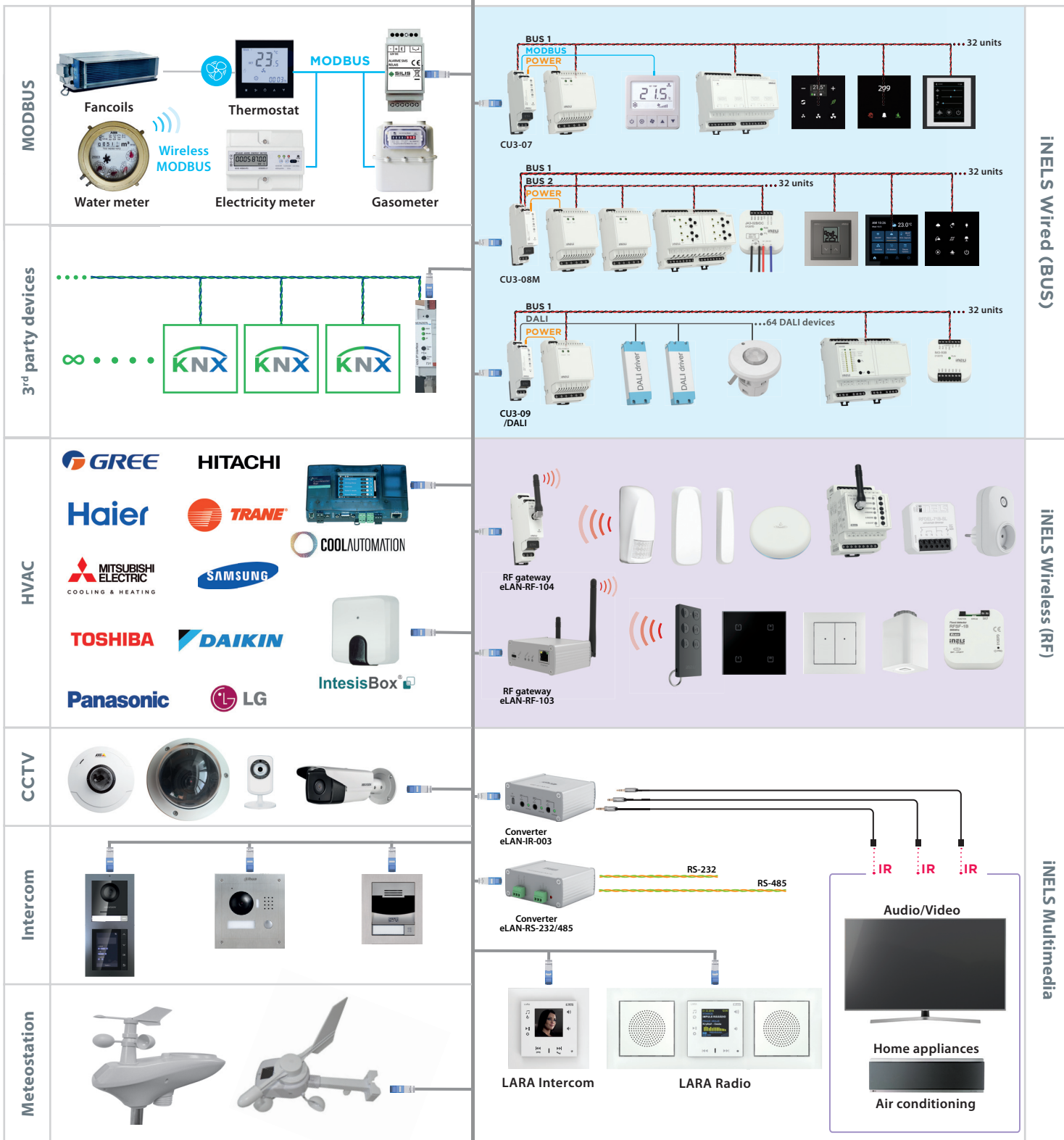
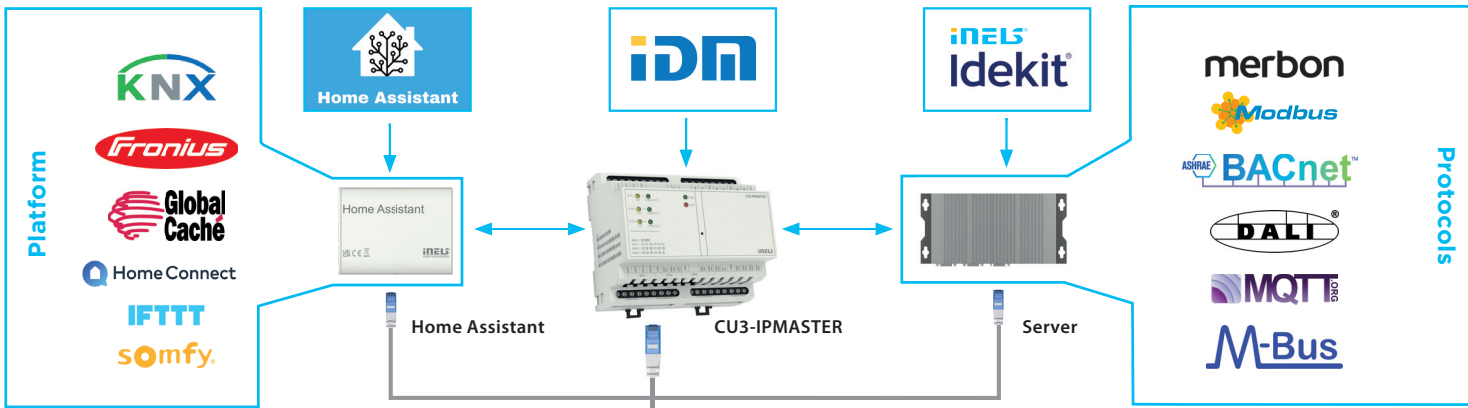

## Overview of system units

### Central units



NEW

**CU3-07M**  
Basic central control unit  
iNELS BUS,  
1 iNELS BUS,  
max. 32 Elements,  
iNELS IP protocol



NEW

**CU3-08M**  
Extended central control unit  
iNELS BUS,  
2 iNELS BUS,  
max. 64 Elements,  
iNELS IP protocol



NEW

**CU3-IPMASTER**  
Superior central control unit  
projects using  
iNELS IP protocol



COMING SOON

**CU3-09M/DALI**  
1 DALI BUS,  
max. 64 addresses,  
1 iNELS BUS,  
max. 32 Elements  
iNELS IP protocol

### System units



NEW

**PS3-30/iNELS**  
Power supply, 30W,  
with bus separator



**PS3-100/iNELS**  
Power supply, 100W



**BPS3-01M, BPS3-02M**  
Bus separator from power supply

### Lighting control



**EMDC-64M**  
Converter iNELS  
EBM - DALI/DMX  
max. 64 address



**DMD3-1**  
Combined  
Motion detector, temperature,  
humidity a intensities lighting



**DLS3-1**  
Intensity sensor  
illuminated

### Converters



**ADC3-60M**  
Analog-to-digital converter,  
6 inputs



**DAC3-04M**  
Digital-to-analog converter,  
4 inputs



**JA3-02B/DC**  
Roller shutter (blind)  
actuator, 2 channels  
(1 controller)



**JA3-018M**  
Roller shutter (blind)  
actuator, 18 channels  
(9 controllers)

### Roller shutter actuators

## Switching actuators



**SA3-01B, SA3-02B**  
Switching actuator,  
1 channel  
and 2 channels



**SA3-04M**  
Switching actuator,  
4 channels



**SA3-06M**  
Switching actuator,  
6 channels



**SA3-012M**  
Switching actuator,  
12 channels



**SA3-022M**  
Switching actuator,  
22 channels

## Dimming actuators



**EA3-022M**  
Switching actuator, 22  
channels, without controls  
and indicator elements



**DA3-22M**  
Universal  
dimming actuator,  
2 channels



**DA3-66M**  
Dimming actuator,  
6 channels



**LBC3-02M**  
Dimming actuator  
for ballasts,  
2 channels

## Input units



**IM3-80B**  
Binary input unit,  
8 channels



**TI3-40B**  
Temperature input,  
4 channels



**IM3-40B**  
Binary input unit,  
4 channels



**TI3-60M**  
Temperature input,  
6 channels



**IM3-140M**  
Binary input unit,  
14 channels

## Combined units



**RC3-610M/DALI**  
Room controller  
with DALI dimmer



**RC3-612M**  
Room controller  
with PHASE dimmers

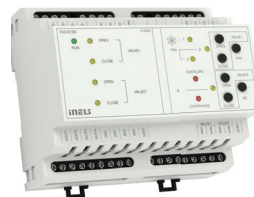

**FA3-612M**  
Special unit  
for controlling fan coils



**IOU3-108M**  
Universal unit with  
inputs and outputs,  
10 inputs, 8 outputs

Wall units and controllers



**EST3**  
Touch control unit Display

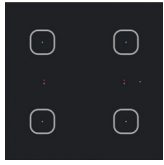

**GSB3-40**  
Wall-mounted glass touch controller



**GSB3-60**  
Wall-mounted glass touch controller



**GSB3-80**  
Wall-mounted glass touch controller

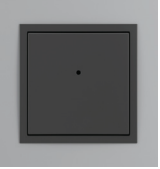

**WSB3-20, WSB3-20H**  
Wall controller, 2 buttons

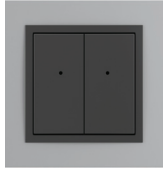

**WSB3-40, WSB3-40H**  
Wall controller, 4 buttons

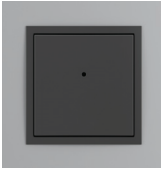

**WMR3-21**  
Wall-mounted card reader

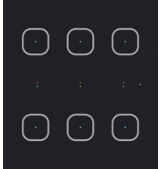

**GMR3-61**  
Wall-mounted glass card reader



**IDRT3-1**  
Digital room thermoregulator

Hotel units

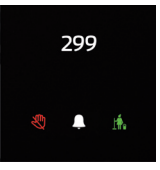

**GCR3-11**  
Glass card reader

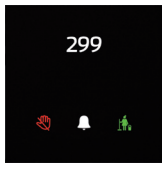

**GDB3-10**  
Glass room doorbell (info panel)

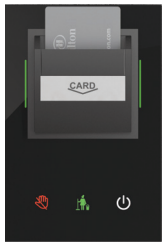

**GCH3-31**  
Hotel control Touch unit and display



**EHT3**  
Hotel control Touch unit and display

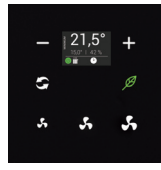

**GRT3-50**  
Glass room thermoregulator

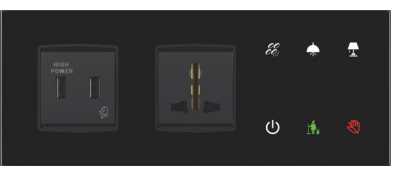

**GBP3-60/xL/2F**  
Glass panel left

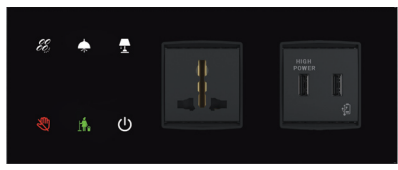

**GBP3-60/xR/2F**  
Glass panel right



**GSB3-20/S**  
Glass touch controller with symbols

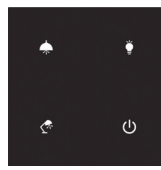

**GSB3-40/S**  
Glass touch controller with symbols

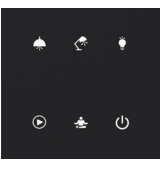

**GSB3-60/S**  
Glass touch controller with symbols

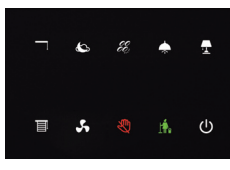

**GSP3-100**  
Glass touch panel

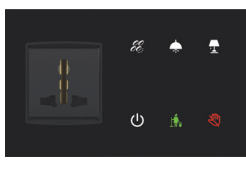

**GBP3-60/xL/1F**  
Glass touch panel left



**GBP3-60/xR/1F**  
Glass touch panel right

Multimedia

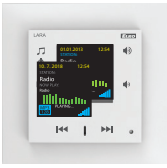

LARA Radio Player  
Internet radio

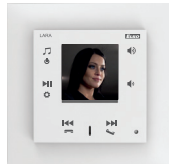

LARA Intercom  
Multifunction communication equipment

Integration



Connection Server  
Third-party integration server



Home Assistant GW  
Integration server Third Parties  
iNELS IP protocol



eLAN-RS485/232  
Converter RS485/232-iNELS



eLAN-IR-003  
Converter Ethernet-IR

Mobile app iNELS

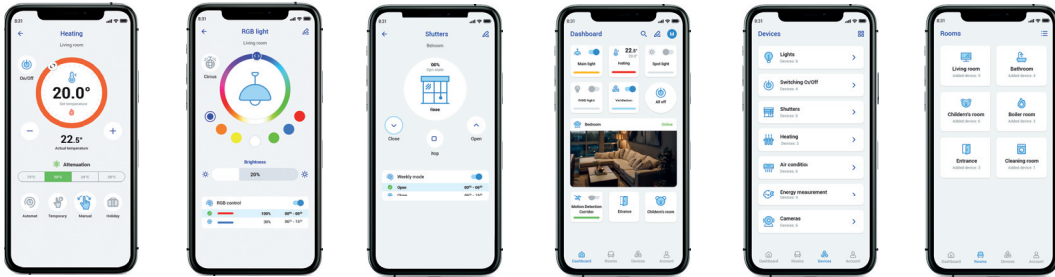

New mobile application for controlling all compatible elements from the iNELS portfolio.

Accessories



TELVA-2 230V,  
TELVA-2 24V  
Thermophones



AN-I,  
AN-E  
Internal antenna  
External antenna



TC,  
TZ,  
Pt100  
Temperature sensors



Central units

cen

tral

units



EAN code  
CU3-07M: 8595188176262

Technical parameters		CU3-07M
<b>Indication LED STATUS</b>		
Green - RUN:	The main program runs	
Red - ERR:	The main program stalled	
<b>Communication</b>		
System bus BUS1/BUS2		
Status indication (LED BUS):	green - indication of the operating status of the bus red - error indication on the bus	
Maximum number of units:	32 units	
Maximum line length:	max. 300 m (depends on power loss)	
<b>Ethernet</b>		
Connector:	RJ45	
Communication speed:	100 Mbps	
Ethernet status indicator	green - communication Ethernet	
(LED ETH):	yellow - speed Ethernet 100 Mbps	
Preset IP address:	192.168.1.1	
<b>RESET button</b>		
Restart:	short press	
Reset (factory reset	press the button to bring power on,	
Settings):	button release 10 s after power is supplied	
<b>Power</b>		
<b>BUS</b>		
Supply voltage/tolerance:	27 V DC, -20/+10 %	
Rated current:	50 mA (at 27 V DC)	
<b>Ethernet POE</b>		
Supply voltage/tolerance:	27 V DC, -20/+10 %	
Current rating:	50 mA (at 27 V DC)	
<b>Operating conditions</b>		
Working temperature:	-20 to +55 °C	
Storage temperature:	-25 to +70 °C	
Air humidity:	max. 80%	
Degree of protection:	IP20 device, IP40 with cover in the control cabinet	
Surge category:	II.	
Degree of pollution:	2	
Working position:	any	
Installation:	to the control cabinet for DIN rail EN 60715	
Design:	1-MODULE	
Terminal plate:	max. 2.5 mm <sup>2</sup>	
<b>Dimensions and weight</b>		
Dimensions:	94 x 17,6 x 64 mm	
Weight:	72 g	

- CU3-07M is the basic system central unit for the control of iNELS BUS collection installations.
- The unit can work independently, as an autonomous project, or it can be controlled by the CU3-IPMASTER central unit as part of a larger project.
- Configuration takes place in the iNELS3 Designer & Manager software (iDM3), or it is possible to control the superior control via the iNELS IP protocol with CU3-IPMASTER units.
- Through iDM3 it is possible to update the firmware of central units and bus-connected peripheral units.
- The CU3-07M system unit is equipped with one BUS to which up to 32 elements from the iNELS BUS portfolio can be connected.
- The RJ45 100 Mbps Ethernet connector is used for communication with the configuration system or for communication with the superior unit within the iNELS IP topology.
- The RJ45 connector can also be used to power the unit in the form of PoE.
- The CU3-07M system units in the 1-MODULE version are designed for mounting in a switchboard on a DIN rail EN60715.

#### Installation BUS:

- Two-wire bus with free topology (only the physical circle must not be closed)
- The communication itself is modulated on DC supply voltage.
- One bus branch allows you to connect max. 32 iNELS3 units, with a current load of max. 1 A. BPS3-01M with a consumption of 3 A can be used when connecting units with a consumption of more than 1 A.
- The maximum length of the BUS branch is about 300 m (depends on the supply voltage drop).
- Recommended cabling:
  - iNELS BUS Cable - twisted pair of solid copper conductors with conductor dimensions AWG20 (diameter 0.8 mm, cross section 0.5 mm<sup>2</sup>).

#### Connection

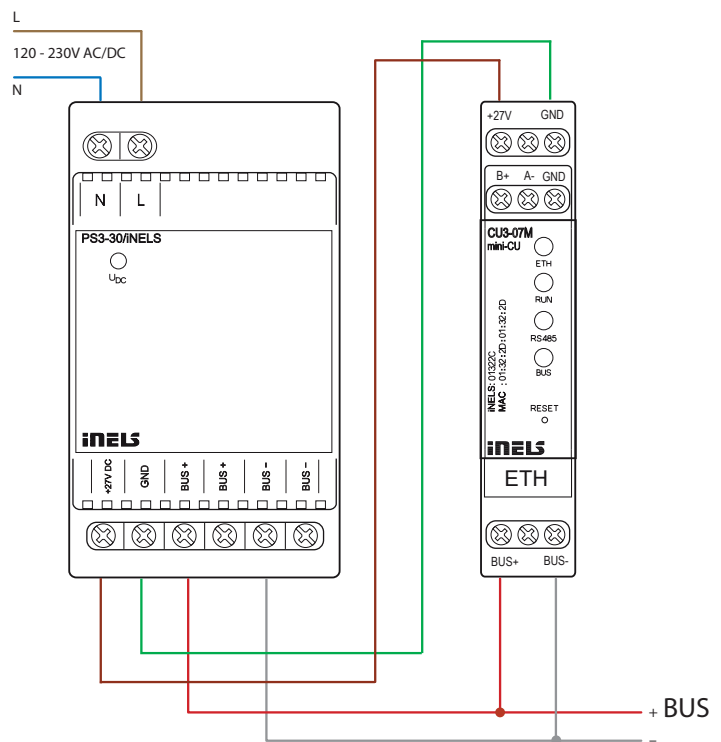

max. 32 units per BUS branch; max. 1A (PS3-30 / iNELS) per BUS branch





FAN code  
CU3-08M: 8595188176262

Technical parameters		CU3-08M
<b>Indication LED STATUS</b>		
Green - RUN:	The main program runs	
Red- ERR:	The main program stalled	
<b>Communication</b>		
System bus BUS1/BUS2		
Status indication (LED BUS):	green - indication of the operating status of the bus red - error indication on the bus	
Maximum number of units:	2x32 Units	
Maximum line length:	max. 300 m (depends on power loss)	
<b>Ethernet</b>		
Connector:	RJ45	
Communication speed:	100 Mbps	
Ethernet status indication	green - Ethernet communication	
(LED ETH):	yellow - Ethernet speed 100 Mbps	
Default IP address:	192.168.1.1	
<b>RESET button</b>		
Restart:	Short press	
Reset (factory reset settings):	press the button to bring power on, button release 10 s after power is supplied	
<b>Power</b>		
<b>BUS1</b>		
Supply voltage/tolerance:	27 V DC, -20/+10 %	
Rated current:	50 mA (at 27 V DC)	
<b>Ethernet POE</b>		
Supply voltage/tolerance:	24 V DC, -20%+20%	
Rated current:	56mA (at 24 V DC)	
<b>Operating conditions</b>		
Working temperature:	-20 to +55 °C	
Storage temperature:	-25 to +70 °C	
Air humidity:	max. 80%	
Degree of protection:	IP20 device, IP40 with cover in the control cabinet	
Surge category:	II.	
Degree of pollution:	2	
Working position:	any	
Installation:	to the control cabinet for DIN rail EN 60715	
Design:	1-MODULE	
Terminal plate:	max. 2.5 mm <sup>2</sup>	
<b>Dimensions and weight</b>		
Dimensions:	94 x 17.6 x 64 mm	
Weight:	72 g	

- Mini CU3-08M is an extended version of the miniified central unit CU3-07M.
- CU3-08M is one of the basic system control units of iNELS BUS installations.
- The unit can work independently, as an autonomous project, or can be controlled by the CU3-IPMASTER central unit as part of a larger Project.
- Configuration takes place in the iNELS3 Designer & Manager software (iDM3), or it is possible to control the superior control via the iNELS IP protocol with CU3-IPMASTER units.
- Through iDM3 it is possible to update the firmware of central units and bus-connected peripheral units.
- The CU3-08M system unit is equipped with two BUSES. Up to 32 elements from the iNELS BUS portfolio can be connected to each bus.
- The BUS1 can also power the central unit.
- The RJ45 100 Mbps Ethernet connector is used for communication with the configuration system or for communication with the superior unit within the iNELS IP topology.
- The RJ45 connector can also be used to power the unit in the form of PoE.
- System units CU3-08M in 1-MODULE design are designed for mounting into a switchboard on DIN rail EN60715.

**Installation BUS:**

- Two-wire bus with free topology (only the physical circle must not be closed).
- The communication itself is modulated on DC supply voltage.
- One bus branch allows you to connect max. 32 iNELS 3 units, with current load max. 1 A. When connecting units with a consumption greater than 1 A, BPS3-01M with a consumption of 3 A can be used.
- The maximum length of the BUS branch is about 300 m (depends on the supply voltage drop).
- Recommended cabling:
- iNELS BUS Cable - twisted pair of solid copper conductors with conductor dimensions AWG20 (diameter 0.8 mm, cross section 0.5 mm<sup>2</sup>).

**Connection**

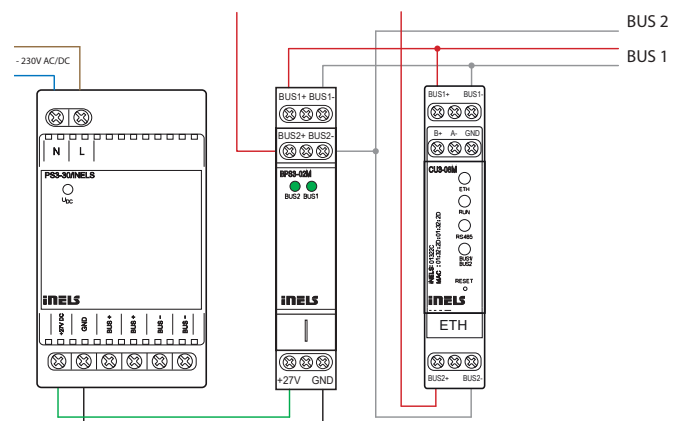

NEW



EAN code  
CU3-IPMASTER: 8595188132404

### Technical parameters

### CU3-IPMASTER

#### Indication LED

Green LED RUN:	Flashing - communication with BUS; lit - no communication
Red LED ERR:	Flashing - missing project; lit - unit stopped

#### Communication

Maximum number of connections IP devices:	50 miniCU
Communication network:	ELKONET

#### 3x Ethernet

Connectors:	RJ45 on the bottom of the product
Communication speed:	100 Mbps
Ethernet status indication:	3x green - Ethernet communication 3x yellow - Ethernet speed 100 Mbps
Preset IP address (ETH3):	192.168.1.1

#### Power

Supply voltage/tolerance:	27 V DC, -20/+10 %
Rated current:	110 mA (at 27 V DC)

#### Operating conditions

Working temperature:	-20 to +55 °C
Storage temperature:	-25 to +70 °C
Air humidity:	max. 80%
Degree of protection:	IP20 device, IP40 with cover in the control cabinet
Surge Category:	II.
Degree of pollution:	2
Working position:	any
Installation:	to the control cabinet for DIN rail EN 60715
Design:	6-MODULE
Terminal plate:	max. 2.5 mm <sup>2</sup>

#### Dimensions and weight

Dimensions:	90 x 105 x 65 mm
Weight:	257 g

- The CU3-IPMASTER central unit is a high-performance commanded control unit designed to control iNELS IP-compliant subordinate units
- Cu3-IPMASTER is designed for fully autonomous control of even very large projects consisting of 1000+ subordinate central or system units. Using the iNELS IP protocol, the unit communicates with the centralized iNELS Cloud environment, which can be used to combine multiple large-scale projects into a centrally controlled project. The iNELS IP protocol also allows the use of the iNELS mobile application to control all devices included in the project.

- Includes 3 Ethernet ports:

**Port 1,2:** for closed communication with miniCU units elko- lem ELKONET. The network created in this way is then used for quick communication between the IP Master and the units of the miniCU series and at the same time directly between the individual miniCUs, according to the project parameter settings.

**Port 3:** it is designed for communication via a public network with the centralized iNELS Cloud system or with the iNELS mobile application.

- Communication speed of Ethernet ports is 100 Mbps.
- The user project and remanent data are stored on nonvolatile internal memory and the data is therefore backed up even without the presence of a voltage.
- Real time backup (RTC) for 10 days. Possibility to set synchronization of time via NTP server.
- Communication and links between individual system elements are set up in the iNELS Designer & Manager configuration software environment, which is designed for Window 7, 8 and 10 systems.

### Connection

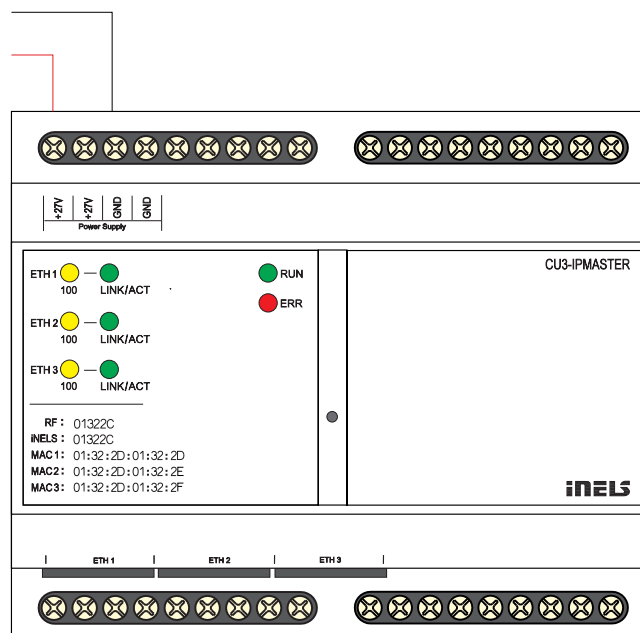



EAN code  
CU3-09M/DALI: 8595188176262

Technical parameters		CU3-09M/DALI
<b>Indication LED STATUS</b>		
Green - RUN:	The main program runs	
Red - ERR:	The main program stalled	
<b>Communication</b>		
<b>System BUS</b>		
Maximum number of units:	max. 32 Units	
Status indication (LED BUS):	Green: Bus Operating Status red: error indication on the bus	
Bus power supply:	external DALI power supply must be connected	
<b>Ethernet</b>		
Connector:	RJ45	
Communication speed:	100 Mbps	
Ethernet status indication (LED ETH):	green - Ethernet communication yellow - speedEthernet 100 Mbps	
Default IP address:	192.168.1.1	
<b>RESET button</b>		
Restart:	short press	
Reset (return to factory settings):	press the button to bring power on, button release 10 s after power is supplied	
<b>Power</b>		
Supply voltage/tolerance:	24 V DC, -10/+25 %	
Rated current:	50 mA (at 27 V DC)	
<b>Operating conditions</b>		
Working temperature:	-20 to +55 °C	
Storage temperature:	-25 to +70 °C	
Air humidity:	max. 80%	
Degree of protection:	IP20 device, IP40 with cover in the control cabinet	
Surge Category:	II.	
Degree of pollution:	2	
Working position:	any	
Installation:	to the control cabinet for DIN rail EN 60715	
Design:	1-MODULE	
Terminal plate:	max. 2.5 mm <sup>2</sup>	
<b>Dimensions and weight</b>		
Dimensions:	94 x 17,6 x 64 mm	
Weight:	72 g	

- Mini CU3-09M/DALI is a special version of the mini-conditioned central one, designed to control DALI electronic ballasts from the iNELS system.
- The unit can work independently, as an autonomous project, or it can be Managed central Unit CU3-IPMASTER like component roz- more reachable Project.
- Configuration takes place in the iNELS3 Designer & Manager software (iDM3), or it is possible to control the parent via iNELS IP communication with CU3-IPMASTER units.
- Through iDM3 it is possible to update the firmware of central units and bus-connected peripheral units.
- The CU3-09M/DALI system unit is equipped with one BUS, one DALI bus and one RJ45 connector.
- Up to 32 elements from the iNELS BUS portfolio can be connected to the system BUS.
- The BUS can also power the central unit.
- The DALI system bus allows control of up to 64 independent DALI (Digital Addressable Lighting Interface) ballast addresses for fluorescent lamps, LEDs and other luminaires.
- Addressing of DALI ballasts can be done via the iDM3 application.
- Dali buses for their operation requires that a soldering source meeting the parameters of the DALI standard be included in the system.
- The RJ45 100 Mbps Ethernet connector is used for communication with the configuration system or for communication with the superior unit within the iNELS IP topology.
- The RJ45 connector can also be used to power the unit for- mou PoE.
- System units CU3-09M/DALI in 1-MODULE design is designed for mounting into the switchboard on DIN rail EN60715.

**Connection**

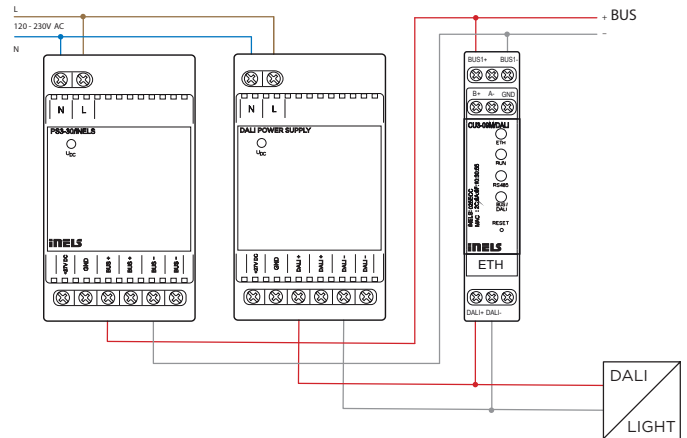



System units

sys

tem

units



EAN code  
PS3-30/iNELS: 8595188180115

### Technical parameters

### PS3-30/iNELS

#### Input AC

Supply voltage:	100 - 250 V AC/50 - 60 Hz
Power dissipation:	max. 6.5 W
No-load power (apparent/active):	max. 10 VA/1.5 W
Power consumption at max. Load (apparent/active):	max. 54 VA/33 W
protection:	T2A fuse inside the device

#### Outputs

Output voltage:	27 V
Max. load capacity	1 A
Overall resource efficiency:	> 82 %
Time delay after Connection to AC network:	max. 5 s

#### Indication LED

Green LED POWER:	Supply voltage indication
Green LED BUS:	indication of the operating status of the bus

#### Operating conditions

Electrical power INPUT AC - OUTPUT BUS:	4 kV
Connection terminals:	Ordinal
Cross-section of connecting wires (mm <sup>2</sup> ):	max. 1 x 2.5, max. 2 x 1.5 (With core max. 1 x 1.5)
Working temperature:	-20 °C to +55 °C
Storage temperature:	-30 °C to +70 °C
Working air humidity:	20 to 90 % RH
Degree of protection:	IP20 device, IP40 with cover in the control cabinet
Surge category:	III.
Degree of pollution:	2
Working position:	any, optimally vertical
Installation:	to the control cabinet for DIN rail EN 60715
Design:	3-MODULE
Dimensions:	90 x 52 x 65 mm
Weight:	160 g
Related standards:	general: EN61204, safety: EN61204-7, EMC: EN61204-3

- PS3-30/iNELS is a switched stabilized power supply with a total power of 30 W.
- PS3-30/iNELS is used to power central units and external masters within the iNELS bus wiring.
- PS3-30/iNELS It is equipped with electronic protection against short circuit, overvoltage, power and temperature overload.
- The power supply includes an internally integrated BPS3-01M bus isolator to power one branch of the BUS, from which the iNELS peripheral units are further powered.
- PS3-30/iNELS 3-MODULE is designed for mounting in a switchboard on DIN rail EN60715.

### Connection

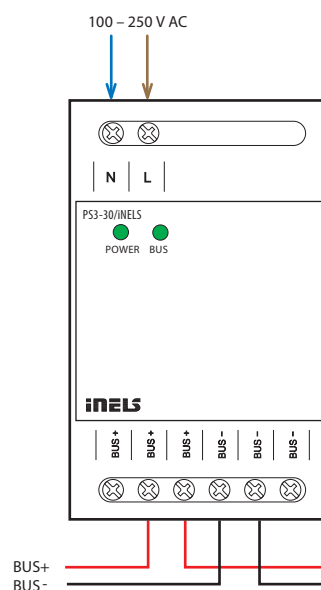



EAN code  
 BPS3-01M: 8595188132442  
 BPS3-02M: 8595188132435

Technical parameters	BPS3-01M	BPS3-02M
<b>Outputs</b>		
Maximum load capacity:	3 A	2x 1 A
<b>Communication</b>		
Installation bus:	1x BUS	2x BUS
<b>Power</b>		
Supply voltage/tolerance:	27 V DC, -20/+10 %	
Power dissipation:	max. 0.5 W	
Rated current without Output load:	max. 8 mA	max. 15 mA
Voltage status indication on Terminals:	1x green LED	2x green LED
<b>Connection</b>		
Terminal plate:	max. 2.5 mm <sup>2</sup> /1.5 mm <sup>2</sup> with core	
<b>Operating conditions</b>		
Working temperature: Storage temperature:	-20 to +55 °C	
Cover:	IP20 device, IP40 with cover in the control cabinet	
Surge category:	II.	
Degree of pollution:	2	
Working position:	any	
Installation:	to the control cabinet for DIN rail EN 60715	
Design:	1-MODULE	
<b>Dimensions and weight</b>		
Dimensions:	90 x 17.6 x 64 mm	
Weight:	70 g	85 g

- The BPS3-01M and BPS3-02M units are used for impedance separation of the BUS from the supply voltage source.
- A BPS3-01M or BPS3-02M bus isolator is required for each CU3-01M (02M) or CU3-05M (06M) central unit and the MI3-02M external master.
- BPS3-01M allows the connection of one BUS branch with a load of max. 3 A.
- BPS3-02M allows the connection of two BUS branches with a load of max. 1 A for each branch.
- The outputs are equipped with overcurrent and surge protection.
- Indication of the output voltage of the BUS outputs by LEDs.
- BPS3-01M, BPS3-02M in 1-MODULE design are designed for mounting in a switchboard on DIN rail EN60715.

Connection

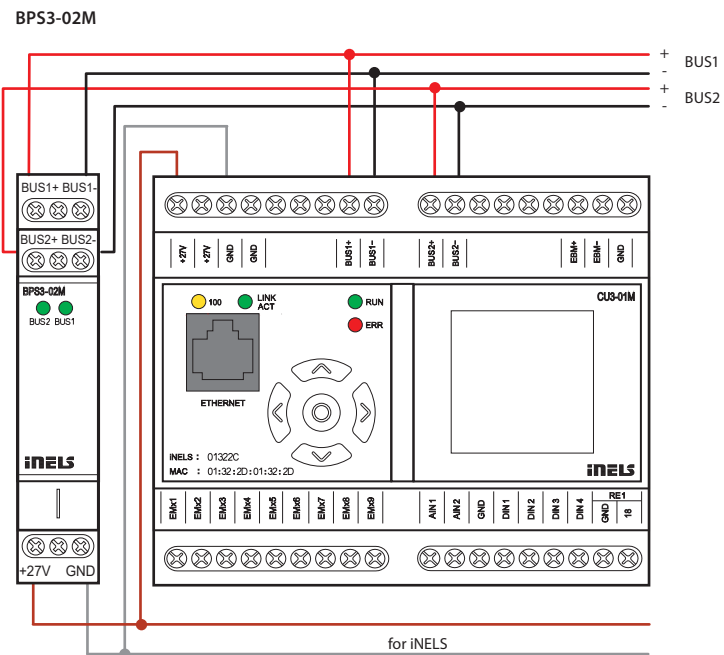
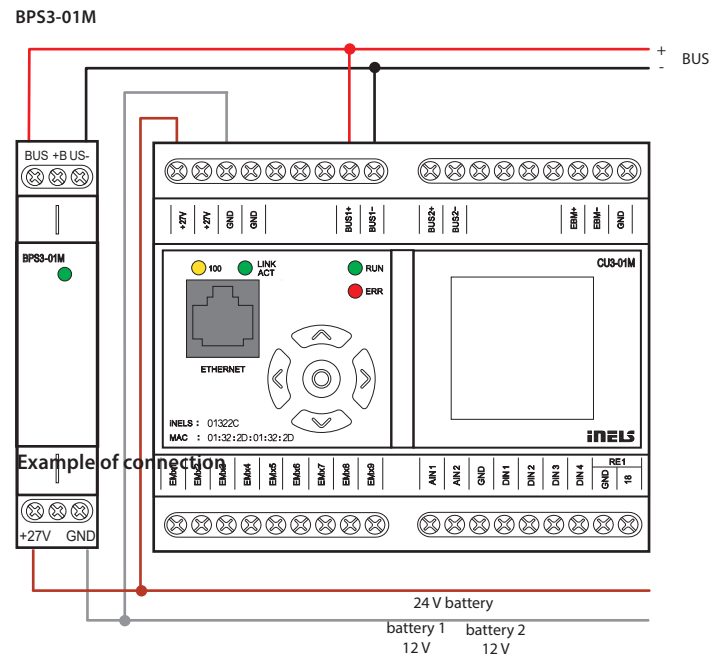

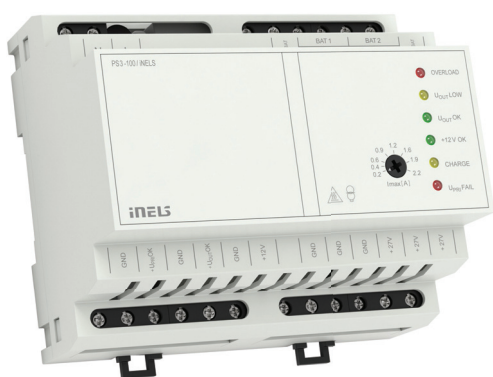

EAN code  
PS3-100/iNELS: 8595188176279

- PS3-100/iNELS is a stabilized switching power supply, with the total power of 100 W.
- Used to supply central units and external master within intelligent electro-installation iNELS.
- Through BUS separators from the supply voltage BPS3-01M and BPS3-02M, it supplies BUS lines from which iNELS peripheral units are also powered.
- Fixed output voltage DC 27.6 V and DC 12.2 V, galvanically isolated from the mains.
- Power source of 27 V and 12 V have a common ground terminal GND.
- Electronic short circuit protection, high-capacity and thermal overload, over voltage detection.
- UPS functions - backup of output 24 V and 12 V on connected batteries.
- Recharging the batteries from 27 V source.
- Protection battery backup fuse - protection against short circuit and reverse polarity battery.
- Continuously adjustable maximum battery charging current.
- Indication of operating and fault conditions 6 LED diodes on the front panel of the power supply.
- 2 STATUS outputs with open collector for reporting operational status of the source.
- Source supplies power to the priority system iNELS, the remaining power is used for rechargeable batteries.
- When the battery is fully discharged, the battery is automatically disconnected from the load.
- PS3-100/iNELS in 6-MODULE version is designed for mounting into a switchboard, on DIN rail EN60715.

LED Signalling

switching power supply works correctly  
output voltage 27 V is correct ( $U_{OUT} > 24 V$ )  
output voltage 12 V is correct  
batteries are not recharged

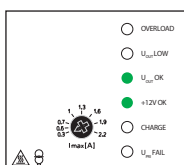

switching power supply not working correctly -  
UPS mode  
output voltage 27 V is correct ( $U_{OUT} > 24 V$ )  
output voltage 12 V is correct  
batteries are not recharged

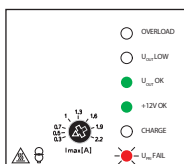

switching power supply works correctly  
output voltage 27 V is correct ( $U_{OUT} > 24 V$ )  
output voltage 12 V is correct  
batteries are recharged

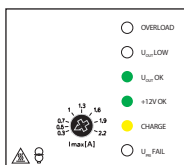

switching power supply not working correctly -  
UPS mode  
low output voltage 27 V ( $21 V < U_{OUT} < 24 V$ )  
output voltage 12 V is correct  
batteries are not recharged

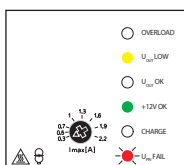

switching power supply works correctly  
low output voltage 27 V ( $21 V < U_{OUT} < 24 V$ )  
output voltage 12 V is correct  
batteries are not recharged

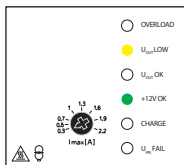

switching power supply works correctly  
output voltage 27 V is correct ( $U_{OUT} > 24 V$ )  
low output voltage 12 V (short-circuit, overload)  
batteries are recharged

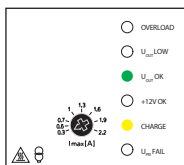

switching power supply is overload  
low output voltage 27 V ( $U_{OUT} < 21 V$ )  
low output voltage 12 V  
batteries are not recharged

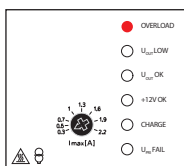

Connection

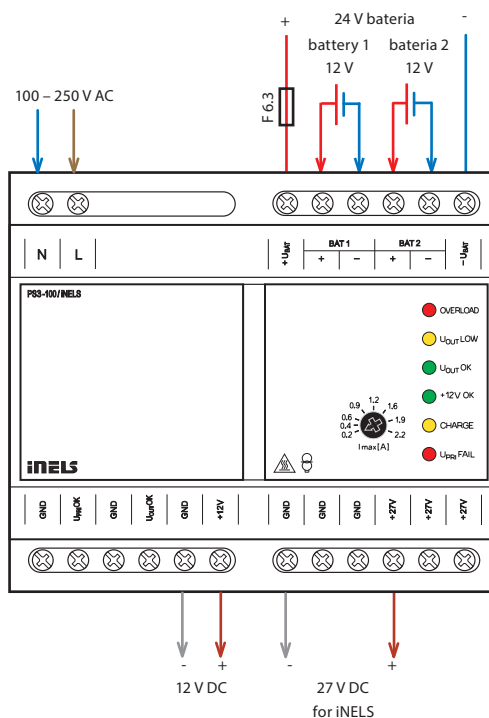



Technical parameters	PS3-100/iNELS
<b>AC Input</b>	
Power supply:	100 - 250 V AC/50 - 60 Hz
Dissipated power:	max. 20 W
Power load (apparent/active):	max. 13 VA/2 W
Power consumption at max. load (apparent/active):	max. 180 VA/111 W
Protection:	- safety fuse T3.15 A inside the unit - electronic protection (short circuit current and thermal overload)
<b>DC Input</b>	
Power supply:	DC 24 V (two 12 V batteries in series)
Protection:	- safety fuse F6.3 A external - electronic protection against current overload
Terminals for connecting the battery:	- each battery separately - separately routed extreme terminals (24)
Automatic disconnect the battery:	- for the battery voltage <21 V - when exceeding discharge current 4.2 A
<b>Outputs</b>	
Output voltage 1:	27.6 V
Max. capacity:	3.6 A
Output voltage 2:	12.2 V
Max. capacity:	0.35 A
The overall efficiency of resources:	about 88 %
Time delay after connecting to the AC network:	max 1 s
Max. charging current:	adjustable from 0.2 to 2.2 A
<b>LED Signalization</b>	
Output voltage 27 V OK ( $U_{OUT} > 24$ V):	green LED $U_{OUT}$ OK
Switch. power supply does not work (does not oscillate):	flashing red LED $U_{PRI}$ FAIL (if a battery is connected)
Low output voltage ( $21$ V < $U_{OUT}$ < 24 V):	yellow LED $U_{OUT}$ LOW
Output voltage 12 V OK ( $U > 11$ V):	green LED + 12 V OK
Overloading the power supply ( $U_{OUT} < 21$ V):	red LED OVERLOAD
Charging the battery (charging current > 50mA):	yellow LED CHARGE
<b>Output status</b>	
STATUS output 1 ( $U_{PRI}$ OK):	closed, when power supply works (not blinking LED $U_{PRI}$ FAIL)
STATUS output 2 ( $U_{OUT}$ OK):	closed, if $U_{OUT} > 21$ V (not lit red LED OVERLOAD)
Output type:	open collector current limited
Max. connectable voltage:	50 V DC
Max. current output:	50 mA
Voltage drop on the switch max:	at 10 mA to 140 mV at 30 mA to 400 mV at 50 mA to 700 mV
<b>Other Data</b>	
Electric strength AC input - output:	4 kV
The connection terminals:	row
Cable size (mm <sup>2</sup> ):	max. 1 x 2.5, max. 2 x 1.5 (with sleeve max 1 x 1.5)
Operating temperature:	-20 °C to +55 °C
Storage temperature:	-30 °C to +70 °C
Working humidity:	20 to 90 % RH
Cover:	IP20 device, IP40 mounting in the switchboard
Overvoltage category:	III.
Degree of pollution:	2
Working position:	arbitrary, vertical is optimum
Installation:	on the DIN rail EN60715
Execution:	6-MODULE
Dimensions:	90 x 105 x 65 mm
Weight:	401 g
Related standards:	general: EN61204, safety: EN61204-7, EMC: EN61204-3

**Description of the device function:**

- Instrument Consists z Several Functional Blocks.
- The basic part consists of a 100 W switched stabilized source with two voltage levels.
  - voltage 27.6 V DC is used to power the iNELS system and also to re-charge backup batteries. Voltage 12.2 V DC is designed for power supply e.g., ESS (PZTS) or EPS detectors.
  - Both functions are available without interruption even in the event of a failure of the AC power supply (UPS function) – provided that the backup batteries are connected.
- Another part of the power supply is the battery backup and charging circuits, which ensure switching the modes of connecting, charging and disconnecting the batteries.
  - if the batteries are completely discharged in the backup mode, the circuit immediately disconnects them to avoid so-called deep discharge.
  - furthermore, the maximum discharge current is monitored – when it is exceeded, the batteries are also disconnected.
  - if the switching power supply is working and its output voltage is greater than 26.9 V, the backup batteries are recharged with a current, the maximum value of which is set by the trimmer on the front panel of the power supply.
  - Battery charging is indicated by a yellow CHARGE LED.
  - the power supply primarily supplies the iNELS system and the remaining power up to 100 W only recharges the batteries.
  - if the output is heavily loaded, the charging is disconnected (the yellow CHARGE LED goes out). As the load increases further, the voltage of the source decreases and the current from the batteries also flows into the load (the source and the battery together supply power to the iNELS system).
  - if the power supply is disconnected from the AC network and if we connect the batteries now, the batteries remain disconnected and the outputs of the power supply are voltage-free. To activate it is necessary to connect the power supply to the mains voltage.
- The last part of the device is signaling circuits and status outputs.
  - STATUS outputs (see technical parameters) are equipped with a current limit, so they can directly switch external signaling elements (e.g., LEDs, optocouplers or relay coils) directly without ballast resistors.
  - The LED signalling on the front panel of the product reports the current states of the power supply. These conditions are described in seven case studies.



Lighting control

light  
ing  
control



EAN code  
EMDC-64M: 8595188150309

### Technical parameters

### EMDC-64M

#### Power supply

Supply voltage/tolerance/	AC 230 V (50 - 60 Hz)/
Rated current:	-15/+10 %/max. 100 mA
DALI power supply:	16 V, 250 mA
Dissipated power:	max. 3 W

#### Communication

Input interface:	EBM BUS (RS485 communication)
Output interface:	DALI (max. 64 ballasts) DMX (max. 32 receivers, with repeater up to 64)

#### Indication

Power supply:	green LED Un
Error surge or short DALI:	illuminated red LED ERR
Indication of unit status:	LED DALI/DMX (see iNELS installation handbook)

#### Operating conditions

Relative humidity:	max. 80 %
Operating temperature:	-20 °C to +55 °C
Storage temperature:	-30 °C to +70 °C
Protection degree:	IP20 device, IP40 mounting in the switchboard
Control device purpose:	operating control device
Control device construction:	individual control device
Characteristic of automatic action:	2.5 kV
Overvoltage category:	II.
Pollution degree:	2
Operating position:	vertical
Installation:	into switchboard on DIN rail EN60715
Implementation:	3-MODULE

#### Dimension and weight

Dimension:	90 x 52 x 65 mm
Weight:	140 g

- The unit EMDC-64M is designed to control DALI electronic ballasts and DMX receivers from the iNELS system.
- EMDC-64M enables control of up to 64 independent electronic ballasts DALI (Digital Addressable Lighting Interface) for fluorescent lamps, LEDs and other light sources.
- EMDC-64M also enables connection of up to 64 DMX receivers (Digital Multiplex).
- Control from iNELS BUS System via EBM BUS.
- DIP switches on the front panel to select the control interface (DALI/DMX).
- Addressing of DALI ballast units can be done via the central unit and iDM3 software or via MINI USB on the front panel of the EMDC-64M and DALI Configurator software.
- The required functionality is set in user project in iDM3 software.
- The unit EMDC-64M is powered from the mains voltage 230 V AC.
- DALI BUS power supply is 16 V/250 mA via an EMDC-64M unit.
- The system BUS EBM is galvanically separated from the BUSes DALI/DMX. Terminals for connecting the DALI BUS are equipped with short circuit and surge protection.
- It is possible to connect up to 8 EMDC-64M units to one EBM BUS.
- If this concerns the last unit on a system BUS EBM, it is necessary to terminate the wire with a resistor with nominal resistance of 120 Ω. The resistor is inside the unit, termination is made by shorting neighboring terminals TERM and EBM+.
- The BUS DMX must be terminated at its end by a resistor with nominal resistive value 120 Ω. The resistor for DMX BUS termination is on the side of the EMDC-64M inside the unit, termination is performed by shorting adjacent terminals TERM and A.
- Updating the firmware of the EMDC-64M can be done through the central unit and software iDM3 or via MINI USB on the front panel and EMDC-64M Flasher software. Updating through MINI USB must be done while system BUS EBM is disconnected.
- When configuring DALI addresses two types are necessary to distinguished:
  - MASTER - this group includes sensors and detectors and one DALI branch can connect up to 4 DALI MASTER units
    - lighting intensity sensor DLS3-1
    - motion detector DMD3-1
  - SLAVE - electronic lighting ballast
- EMDC-64M in 3-MODULE design is designed for mounting in a control panel on a DIN rail EN60715.

### Connection

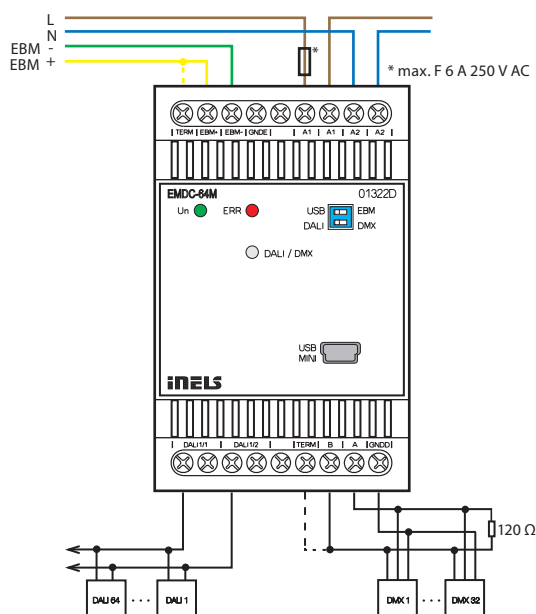



EAN code  
DMD3-1: 8595188157513

Technical parameters		DMD3-1
<b>Inputs</b>		
Angle of motion detection:	140°, 4 m	
Recommended installation height:	2.5 - 3 m	
Changing the PIR sensitivity:	yes, 0 to 127 (max. sensitivity)	
PIR scan type:	single/dual	
Default setup PIR:	99 dual	
Temperature measuring:	yes, built-in temperature sensor	
Scope and accuracy of temp. measurement:	-25 to +110 °C; ± 0.3 °C	
Humidity measurement:	YES	
Humidity meas. range:	0 to 99 % RH	
Humidity meas. accuracy:	± 4 % RH	
Light Metering:	yes	
Detection angle:	± 55°	
Measuring range:	1 - 100 000 lx	
Number of control buttons:	1	
<b>Outputs</b>		
Indication red LED:	identification DALI MASTER/communication options	
Indicating blue LED:	PIR activation	
Indication green LED RUN:	communications/unit status	
<b>Communication</b>		
Interface:	installation iNELS BUS, DALI	
<b>Power supply</b>		
From iNELS BUS:	27 V DC, -20/+10 %	
Rated current:	18 mA	
From DALI BUS:	16 V (max. 23 V)	
Rated current:	27 mA	
Dissipated power:	max. 0.5 W	
<b>Connection</b>		
Terminals:	0.3 - 0.8 mm <sup>2</sup>	
<b>Operating conditions</b>		
Operating temperature:	-20 to +55 °C	
Storing temperature:	-30 to +70 °C	
Protection degree:	IP20	
Operation position:	vertical	
Installation:	ceiling	
<b>Dimension and weight</b>		
Dimension:	Ø 76 x 73 mm	
- installation hole diameter:	60 mm	
- diameter visible:	76 mm	
Weight:	81 g	

For proper function of the detector it is necessary to eliminate all interference from heat or light sources in the sensing area.

The detector cannot be installed on an unstable or vibrating surface.

Lower mounting height will reduce the overall size of the detection zone.

The distance from the unit and the colour of the illuminated area affects the resulting value of the measured illumination by the DMD3-1 unit.

- DMD3-1 is a combined detector for ceiling mounting.
- Possibilities to use the DMD3-1:
  - motion detector
  - sensor luminescence
  - temperature measuring
  - humidity measurement
- The unit is equipped with two communication interfaces:
  - installation iNELS BUS.
  - DALI (a maximum 4 pcs of DMD3-1 or DLS3-1 units can be used on one DALI bus).
- The motion detector is used to detect people moving in the area. Using the passive scanning infrared spectrum for detection.
- Integrated luminescence sensor can be used for sensing current luminescence at the point of installation of the unit. This information can be used in tasks to maintain a constant luminescence. In space where it is possible, thanks to the contribution of natural light from the outside to adjust the artificial light, which can reduce energy consumption.
- Setting the communication interface is done using the SET button.
- The unit can be configured via the iNELS3 Designer & Manager software, which, among other things it is possible to:
  - set the desired function depending on detected motion
  - resolve jobs based on the value of luminescence
  - enable/disable the alarm LED on the detector housing
- DMD3-1 detector is designed for indoor installation and is not intended for outdoor use.
- DMD3-1 detector is powered directly via the iNELS BUS installation (nominal 27 V DC) or DALI BUS (nominal 16 V DC).

Connection

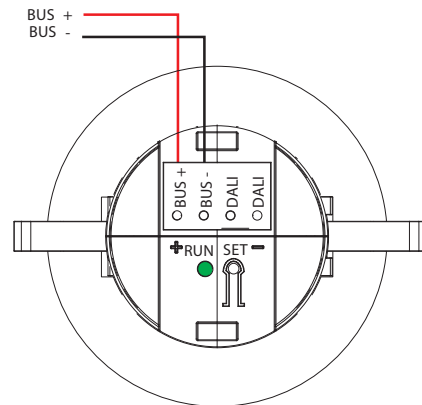

Scanning range

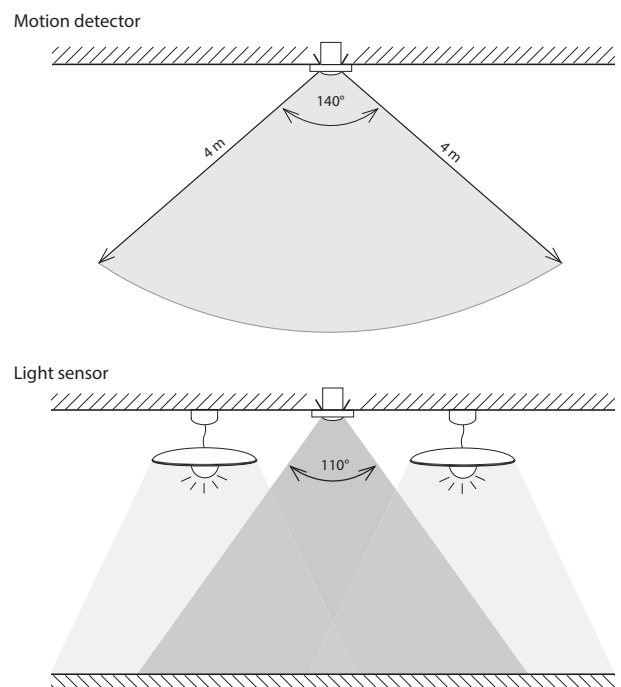



EAN code  
DLS3-1: 8595188157506

Technical parameters		DLS3-1
<b>Inputs</b>		
Range of measurement of lighting:	1 - 100 000 lx	
Detection angle:	40 °	
<b>Outputs</b>		
Indication red LED:	identification DALI MASTER/setting indication	
Indication green LED RUN:	communications/unit status	
<b>Communication</b>		
Interface:	installation iNELS BUS, DALI	
<b>Power supply</b>		
From iNELS BUS:	27 V DC, -20/+10 %	
Rated current:	12 mA (27 V DC)	
From DALI BUS:	16 V (max. 23 V)	
Rated current:	20 mA (16 V DC)	
Dissipated power:	max. 0.5 W	
<b>Connection</b>		
Terminals:	max. 1x2.5, max. 2x1.5/with sleeve max. 1x2.5 mm <sup>2</sup>	
<b>Operating conditions</b>		
Operating temperature:	-30 to +60 °C	
Storing temperature:	-30 to +70 °C	
Protection degree:	IP65	
Operating position:	vertical	
<b>Dimension and weight</b>		
Dimension:	96 x 62 x 34 mm	
Weight:	100 g	

For proper function of the detector it is necessary to eliminate all sources of light interference in the sensing area.

- The luminescence sensor DLS3-1 is for sensing the current luminescence at the point of installation of the unit.
- The DLS3-1 sensor is equipped with two communication interfaces:
  - iNELS BUS installation
  - DALI (a maximum 4 pcs of DMD3-1 or DLS3-1 units can be used on one DALI bus).
- Information about the current value of the light intensity can be used in tasks of maintaining constant luminescence. In space where it is possible, thanks to the contribution of natural light from the outside to adjust the artificial light, which can reduce energy consumption.
- Thanks to the DLS3-1 units cannot only be used in residential projects, but also in commercial projects, offices or manufacturing plants, warehouses.
- The DLS3-1 unit is recommended to be installed so that the luminescence sensor for sensing faces down and should not be exposed to direct radiation.
- Setting up a communication interface with DIP switches no. 1:
  - in the upper position determines the communication interface DALI
  - in the lower position determines the communication interface iNELS.
- The DLS3-1 detector is powered directly via the iNELS BUS installation (nominal 27 V DC) or DALI BUS (nominal 16 V DC).
- The unit can be configured via iNELS3 Designer & Manager software, which, amongst other things it is possible to:
  - Set the desired functions according to the detected illumination.
  - The sensing range is 1-100 000 lux.
  - The DLS3-1 unit is supplied in IP65 and so can be installed in the outdoor environment.

## Connection

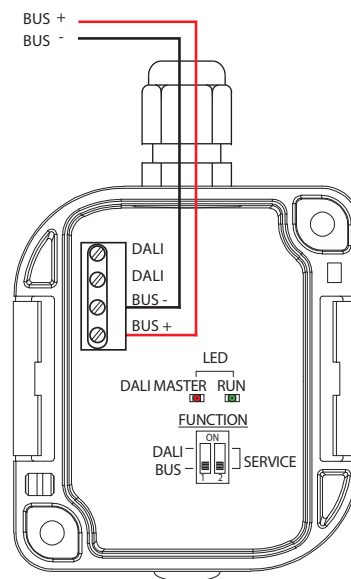

Converters

con

ver

ters



EAN code  
ADC3-60M: 8595188133012

### Technical parameters

### ADC3-60M

#### Input

Analog inputs:	6x voltage, current or temperature input
Number of inputs:	6
Galv. separation from inner circuits:	no
Diagnostic:	indication (exceeding the range, interruption of a sensor or overload of Uref output) by the applicable red LED
Common terminal:	COM
Converter resolution:	14 bits
Input resistance	
- for voltage ranges:	approx. 150 k $\Omega$
- for current ranges:	100 $\Omega$
Types of inputs/measuring ranges*:	<b>Voltage (U):</b> 0 ÷ +10 V (U) ; 0 ÷ +2 V (U) <b>Current (I) :</b> 0 ÷ +20 mA (I) ; 4 ÷ +20 mA (I) <b>temperature:</b> input at ext. temperature sensor TC, TZ see accessories/according to used sensor from -40 °C to 125 °C

#### Outputs of the Uref1 and Uref2 voltage

Voltage**/current of Uref1:	10 or 15 V DC/100 mA
Voltage**/current of Uref2:	10 V DC/20 mA

#### Communication

Installation BUS:	BUS
Unit status indication:	green LED RUN

#### Power supply

Supply voltage/tolerance:	27 V DC, -20/+10 %
Dissipated power:	max. 1 W
Rated current:	100 mA (at 27 V DC), from BUS

#### Connection

Terminal:	max. 2.5 mm <sup>2</sup> /1.5 mm <sup>2</sup> with sleeve
-----------	---

#### Operating conditions

Operating temperature:	-20 to +55 °C
Storing temperature:	-30 to +70 °C
Protection degree:	IP20 device, IP40 mounting in the switchboard
Overvoltage category:	II.
Pollution degree:	2
Operating position:	any
Installation:	into a switchboard rail to DIN EN 60715
Design:	3-MODULE

#### Dimensions and weight

Dimensions:	90 x 52 x 65 mm
Weight:	112 g

\* selectable for each input/output individually by configuration in the user program iDM3. Min. supply voltage 24 V DC must be respected when configuring 15 V DC and 100 mA consumption.

\*\* according to load Uref output.

- ADC3-60M is an analog-to-digital converter and is equipped with 6 analog inputs.
- Analog inputs serve to connect temperature sensors or analog sensors that generates current or voltage signal.
- The analog inputs have a resolution of a 14-bit AD converter.
- The analog inputs have a common terminal COM.
- Analog inputs/outputs are configurable in iDM3 independently as voltage (U) or current (I) or temperature.
- We recommend Clima sensor as a meteo station. There are four types: five to eight outputs. The top series offers measuring of: rainfall, brightness, speed of wind, temperature and relative humidity.
- The red LEDs in the front panel indicate exceeding the range, interruption of a sensor or overload of Uref output.
- The temperature inputs at the top of the terminal are used to connect the following temperature sensors: TC, TZ.
- ADC3-60M in 3-MODULE version is designed for mounting into a switchboard, on a DIN rail EN60715.

### Connection

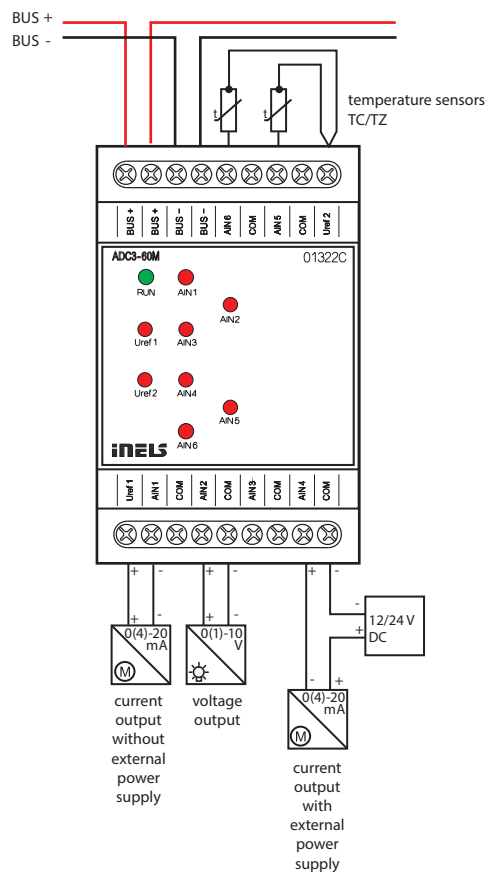





EAN code  
DAC3-04M: 8595188132565

**Technical parameters** **DAC3-04M**

Input	
Temperature measuring:	yes, input for external temperature sensor TC/TZ
Range/accuracy of temp. measuring:	-20 to +120 °C; 0.5 °C from the range
Outputs	
Analog voltage output/rated current:	4x 0(1)-10 V/10 mA
Indication of output overload:	red LED OVERLOAD
Communication	
Installation BUS:	BUS
Status indication unit:	green LED RUN
Power supply	
Supply voltage/tolerance:	27 V DC, -20/+10 %
Dissipated power:	max. 1 W
Rated current:	50 mA (at 27 V DC), from BUS
Connection	
Terminal:	max. 2.5 mm <sup>2</sup> /1.5 mm <sup>2</sup> with sleeve
Operating conditions	
Air humidity:	max. 80 %
Operating temperature:	-20 to +55 °C
Storing temperature:	-30 to +70 °C
Protection degree:	IP20 device, IP40 mounting in the switchboard
Overvoltage category:	II.
Pollution degree:	2
Operating position:	any
Installation:	switchboard on DIN rail EN 60715
Design:	3-MODULE
Dimensions and weight	
Dimensions:	90 x 52 x 65 mm
Weight:	108 g

- DAC3-04M is a converter from a digital signal to an analog voltage signal.
- The converter generates 4 analog voltage signals, which can be operated, according to type of controlled device, in a range 0-10 V or 1-10 V.
- This is used for regulating and controlling devices that may be controlled by this signal (dimnable ballasts of fluorescent lamps and other types of light sources - e.g. LED panels from the assortment of ELKO Lighting, dimming actuator for LED and RGB strips RFDA-73M/RGB, thermo drives, servo drives, elements for measuring and regulation and others).
- Range of output voltage is adjustable in iDM3.
- Converter is equipped with a temperature input for connecting a 2-wire external sensor TC/TZ (see accessories).
- DAC3-04M in 3-MODULE version is designed for mounting into a switchboard, on DIN rail EN60715.

**Connection**

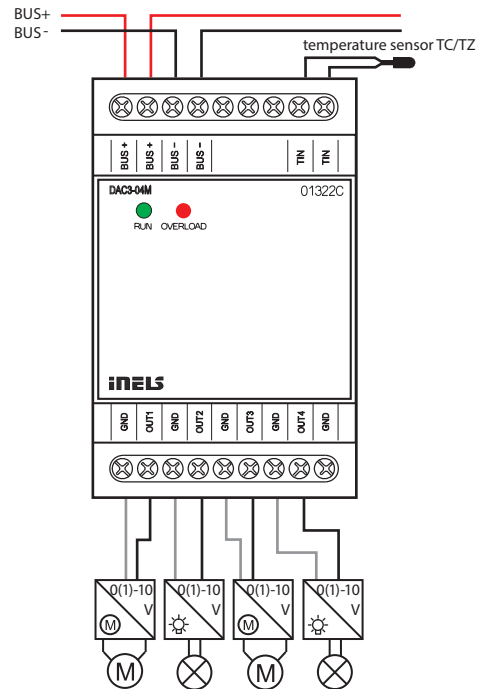



Roller shutter actuators

roller

shut

ters

actuator



EAN code  
JA3-02B/DC: 8595188132718

Technical parameters	JA3-02B/DC
<b>Inputs</b>	
Inputs:	2x AIN/DIN
Resolution:	bit 10
Ext. temperature sensor:	the connection between AIN1/DIN1 and AIN2/DIN2
Type of ext. sensor:	TC/TZ
Temperature measurement range:	-20°C to +120°C
Temperature measurement accuracy:	0.5 °C from range
<b>Outputs</b>	
Insulative voltage between outputs and internal circuits:	3.75 kV, SELV by EN 60950
Rated current:	0.85 A*
Peak current:	1.5 A/< 3s
Switched voltage:	12-24 V DC
Output indication UP, (↗):	red (orange) LED
Output indication DOWN, (↘):	green LED
<b>Communication</b>	
Installation BUS:	BUS
<b>Power supply</b>	
Supply voltage/tolerance:	27 V DC, -20/+10 %
Dissipated power:	max. 1 W
Rated current:	60 mA (at 27 V DC), from BUS
Status indication unit:	green LED RUN
<b>Connection</b>	
Data terminals:	terminal 0.5 - 1 mm <sup>2</sup>
Power outputs:	4x conductor CY, 0.75 mm <sup>2</sup>
<b>Operating conditions</b>	
Operating temperature:	-20 to +50 °C
Storage temperature:	-30 to +70 °C
Protection degree:	IP30
Control device purpose:	operative control device
Control device construction:	individual control device
Characteristics of automatic operation:	1.B.E
Heat and fire resistance category:	FR-0
Anti-shock category (immunity):	class 2
Rated impulse voltage:	2.5 kV
Overvoltage category:	II.
Pollution degree:	2
Operation position:	any
Installation:	into an installation box
<b>Dimensions and weight</b>	
Dimensions:	49 x 49 x 13 mm
Weight:	32 g

\* Maximal operation time of outputs with rated current 0.85 A is 10 minutes...after that the output heating protection activates. The lower the current, the longer duration of protection.

- JA3-02B/DC actuator serves to control blinds, shutters, garage doors, entrance gates, etc.
- Actuator can control electrical motors, which are controlled in 2 directions and have a built-in limit switch.
- JA3-02B/DC controls electric drives with supply voltages up to 24 V DC, where the direction of rotation of the driver is controlled by changing the voltage polarity of the motor.
- The unit is equipped with thermal and overcurrent overload protection of outputs.
- Status of units is indicated by green LED RUN on the front panel:
  - with the supply voltage connected (through BUS) and the unit is not controlled by BUS, LED RUN shines.
  - with the supply voltage connected (through BUS) and the unit is controlled by BUS, LED RUN flashes.
- Status of output contacts UP/DOWN (↗/↘):
  - while contact UP (↗) is switched, red LED shines (orange).
  - while contact DOWN (↘) is switched, green LED shines.
- The unit is also equipped with two analog digital inputs (AIN/DIN), which can be used to connect two potential free contacts (e.g. to connect double button for local control) or a single external temperature sensor TC/TZ (see accessories).
- JA3-02B/DC is designed for mounting into an installation box.

### Connection

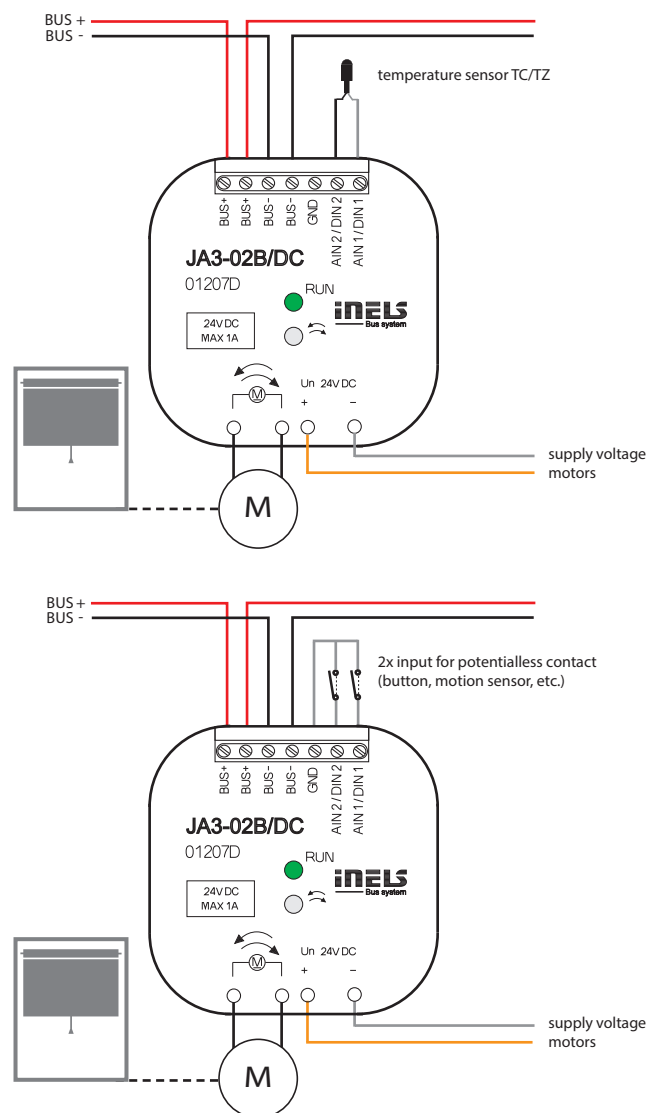



EAN code  
JA3-018M: 8595188174466

Technical parameters		JA3-018M
<b>Outputs</b>		
Output:	9x changeover 4 A/AC15	
Switched voltage:	250 V AC, 24 V DC	
Switched output:	1000 W/AC15, 100 W/DC	
Peak current:	10 A	
Output relays separated from all internal circuits:	basic insulated (Cat. III surges by EN 60664-1)	
Isolation between relay outputs GATE1, GATE2 and GATE3:	basic insulated (Cat. II surges by EN 60664-1)	
Isolates. voltage open relay contact:	1 kV	
Minimal switched current:	100 mA/10 V DC	
Switching frequency without load:	300 min <sup>-1</sup>	
Switching frequency with rated load:	15 min <sup>-1</sup>	
Mechanical life:	1x 10 <sup>7</sup>	
Electrical life AC1:	1x 10 <sup>5</sup>	
Output indication:	9x yellow LED	
<b>Communication</b>		
Installation BUS:	BUS	
Status indication unit:	green LED RUN	
<b>Power supply</b>		
Supply voltage by BUS/ tolerance/nominal current:	27 V DC, -20/+10 %, 5mA	
Supply voltage of power section (relay) tolerance/nominal current:	AC 230 V (50 Hz), -15/+10 %, 20 mA	
Dissipated power:	max. 2 W	
<b>Connection</b>		
Terminal:	max. 2.5 mm <sup>2</sup> /1.5 mm <sup>2</sup> with sleeve	
<b>Operating conditions</b>		
Operating temperature:	-20 to +55 °C	
Storing temperature:	-30 to +70 °C	
Protection degree:	IP20 device, IP40 mounting in the switchboard	
Overvoltage category:	II.	
Pollution degree:	2	
Operating position:	vertical	
Installation:	switchboard on DIN rail EN 60715	
Design:	6-MODULE	
<b>Dimensions and weight</b>		
Dimensions:	90 x 105 x 65 mm	
Weight:	346 g	

- JA3-018M is an actuator designed for controlling rollers, shutters, blinds, awnings, garage doors, entrance gates, etc.
- It controls electric drives that are controlled in two directions and have a built-in limit switch.
- The unit's status is indicated by the green RUN LED on the front panel
  - if the power supply is connected, but there is no communication via BUS with master, the LED RUN is on continuously.
  - if the supply voltage is connected and the unit communicates by BUS, the LED RUN flashes.
- The status of the output contacts is indicated by the U/D LED:
  - when the blind/roller blind is moving up/down, the corresponding LED lights up.
  - if the number of switching operations per minute is exceeded, the corresponding LED flashes.
- JA3-018M in 6-MODULE version is designed for mounting into a switchboard on DIN rail EN60715.

Connection

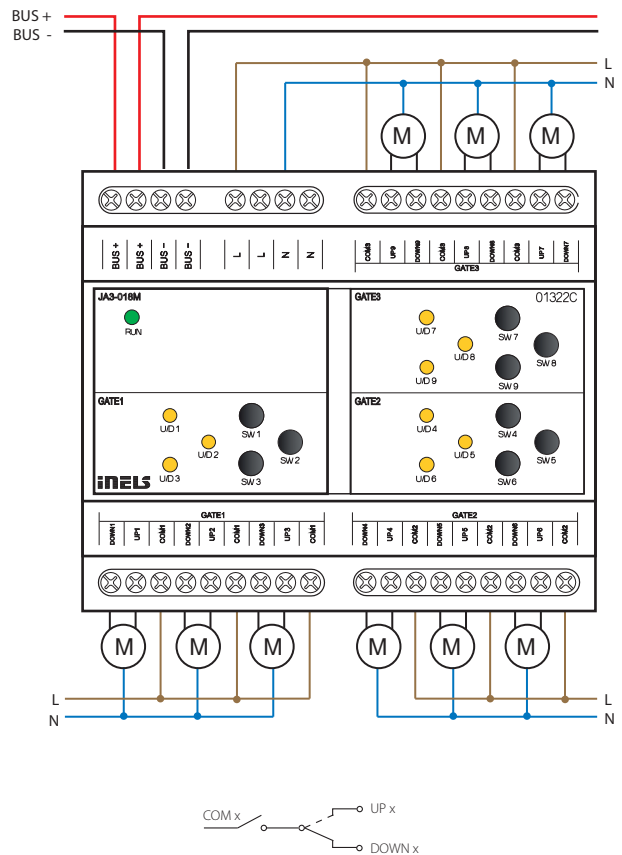



Switching actuators

switch

ing

actuator

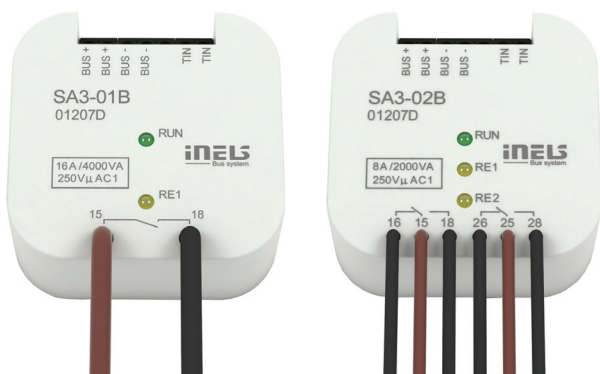

EAN code  
SA3-01B: 8595188132350  
SA3-02B: 8595188132367

Technical parameters	SA3-01B	SA3-02B
<b>Inputs</b>		
Temperature measuring:	Yes, input for external thermo sensor TC, TZ	
Scope and accuracy of tem.meas.:	-20 to +120°C; 0.5°C from the range	
<b>Outputs</b>		
Output:	1x switching 16 A/AC1	2x changeover 8 A/AC1
Switching voltage:	250 V AC, 24 V DC	
Switched load:	4000 VA/AC1, 384 W/DC	2000 VA/AC1, 192 W/DC
Surge current:	30 A; max. 4 s. when repeating 10%	10 A
Output relays separated from all internal circuits:	reinforced insulation (Cat. II surges by EN 60664-1)	
Insulation voltage between relay outputs RE1-RE2:	x	basic isolation (Cat. II surges by EN 60664-1)
Minimal switching current:	100 mA/5 V	
Switching frequency/no load:	1200 min <sup>-1</sup>	300 min <sup>-1</sup>
Switching frequency/rated load:	6 min <sup>-1</sup>	15 min <sup>-1</sup>
Mechanical lifetime:	3x 10 <sup>7</sup>	1x 10 <sup>7</sup>
Electrical lifetime for AC1:	0.7x 10 <sup>5</sup>	1x 10 <sup>5</sup>
Output indication:	yellow LED	2x yellow LED
<b>Communication</b>		
Installation BUS:	BUS	
<b>Power supply</b>		
Supply voltage/tolerance:	27 V DC, -20/+10 %	
Dissipated power:	max. 4 W	
Rated current:	30 mA (at 27 V DC)	50 mA (at 27 V DC)
Status indication unit:	green LED RUN	
<b>Connection</b>		
Data terminals:	terminal, 0.5 - 1 mm <sup>2</sup>	
Power outputs:	2x conduct. CY, Ø 2.5 mm <sup>2</sup>	6x conduct. CY, Ø 0.75 mm <sup>2</sup>
<b>Operating conditions</b>		
Operating temperature:	-20 to +55 °C	
Storage temperature:	-30 to +70 °C	
Protection degree:	IP30	
Overvoltage category:	II.	
Pollution degree:	2	
Operating position:	any	
Installation:	into installation box	
<b>Dimensions and weight</b>		
Dimensions:	49 x 49 x 21 mm	
Weight:	50 g	50 g

- Actuators are designed for switching of one (SA3-01B), respectively two (SA3-02B) of various appliances and loads by relay outputs (potentialless contacts).
- SA3-01B contains 1 relay with switching potentialless contact with max. load 16 A/4000 VA/AC1.
- SA3-02B contains 2 relays with switching potentialless contacts with max. load 8 A/2000 VA/AC1.
- Output contacts are separately controllable and addressable.
- Thanks to changeover contacts, the SA3-02B actuator can be used to control a 230 V drive (such as blinds, shutters or awnings), whereas by proper bridging of contacts, it is possible to secure locking hardware options while switching on phase two outputs.
- Actuators are equipped with a temperature input for connecting an external two-wire temperature sensor TC/TZ (see accessories).
- LED on front panel signalizes state of each output.
- SA3 is normally supplied in the option AgSnO<sub>2</sub> contact material.
- SA3-01B, SA3-02B are designed for mounting into the installation box.

### Connection

#### SA3-01B

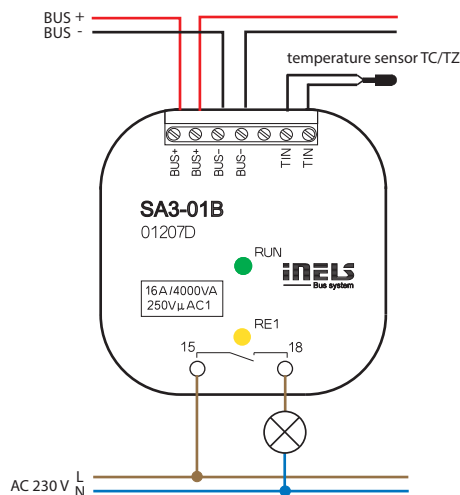

#### SA3-02B

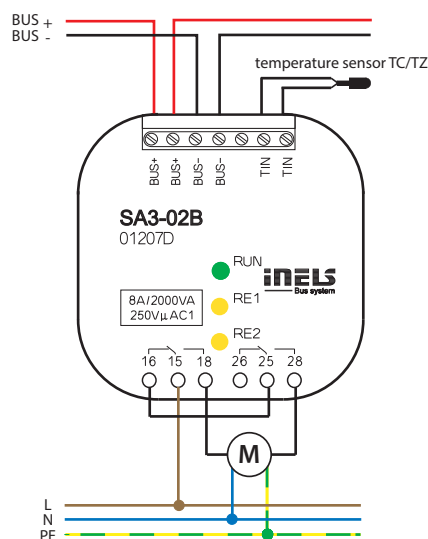





EAN code  
SA3-04M: 8595188132381

## Technical parameters

## SA3-04M

### Outputs

Output:	4x changeover 16 A/AC1
Switching voltage:	250 V AC, 24 V DC
Switching output:	4000 VA/AC1, 384 W/DC
Surge current:	30 A; max. 4 s. at 10% duty cycle
Output relays separated from all internal circuits:	reinforced insulation (Cat. II surges by EN 60664-1)
Isolation between relay outputs RE1-3 and RE4:	reinforced insulation (Cat. II surges by EN 60664-1)
Isolation between relay outputs RE1-3:	basic insulated (Cat. II surges by EN 60664-1)
Isolates. voltage open relay contact:	1 kV
Min. switched current:	100 mA
Switching frequency/no load:	1200 min <sup>-1</sup>
Switching frequency/rated load:	6 min <sup>-1</sup>
Mechanical life:	3x 10 <sup>7</sup>
Electrical life AC1:	0.7x 10 <sup>5</sup>
Output indication:	4x yellow LED

### Communication

Installation BUS:	BUS
-------------------	-----

### Power supply

Supply voltage/tolerance:	27 V DC, -20/+10 %
Dissipated power:	max. 4 W
Rated current:	70 mA (at 27 V DC), from BUS
Status indication unit:	green LED RUN

### Connection

Terminal:	max. 2.5 mm <sup>2</sup> /1.5 mm <sup>2</sup> with sleeve
-----------	---

### Operating conditions

Air humidity:	max. 80 %
Operating temperature:	-20 to +55 °C
Storing temperature:	-30 to +70 °C
Protection degree:	IP20 device, IP40 mounting in the switchboard
Overvoltage category:	II.
Pollution degree:	2
Operation position:	any
Installation:	switchboard on DIN rail EN 60715
Design:	3-MODULE

### Dimensions and weight

Dimensions:	90 x 52 x 65 mm
Weight:	164 g

- SA3-04M is a switching actuator containing 4 independent relays with changeover potential-free contacts.
- Maximum load per contact is 16 A/4000 VA/AC1.
- Each of the 4 outputs contacts are individually controllable and addressable.
- All four relays are individually decorated input terminals, and therefore can switch various independent potentials.
- The actuator is designed for switching 4 various appliances or loads by relay outputs (potential free contacts).
- Thanks to changeover contacts, it can be used to control up to two drives 230 V power (such as blinds, shutters or awnings) with appropriate bridging, the contacts can secure hardware blocking the possibility of simultaneous switching of the phase on both outputs, see example of connection.
- LEDs on the front panel signal the status of each output.
- Contact status of each relay can be changed separately and manually by control buttons on a front panel.
- Switching actuators SA3 is normally supplied in the option AgSnO<sub>2</sub> contact material.
- SA3-04M in 3-MODULE version is designed for mounting into a switchboard, on DIN rail EN60715.

### Connection

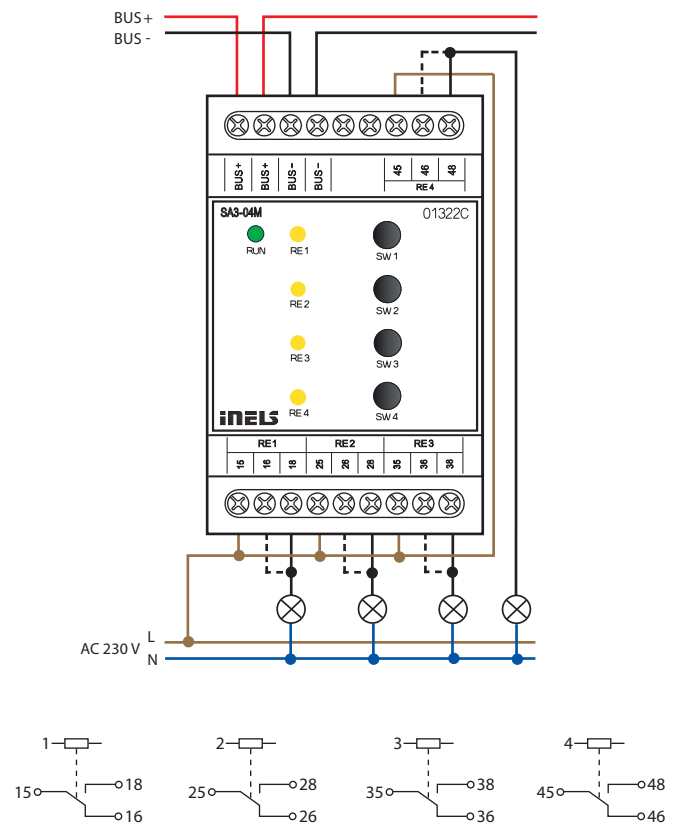



EAN code  
SA3-06M: 8595188132879

### Technical parameters

### SA3-06M

#### Outputs

Output:	6x changeover 8 A/AC1
Switching voltage:	250 V AC, 24 V DC
Switching output:	2000 VA/AC1, 192 W/DC
Surge current:	10 A
Output relays separated from all internal circuits:	reinforced insulation (Cat. II surges by EN 60664-1)
Isolation between relay outputs COM1 and COM2:	reinforced insulation (Cat. II surges by EN 60664-1)
Isolation between individual relay outputs:	basic insulated (Cat. II surges by EN 60664-1)
Isolates voltage open relay contact:	1 kV
Max. current terminals COM1 and COM2:	16 A
Min. switched current:	100 mA/5 V DC
Switching frequency/no load:	300 min <sup>-1</sup>
Switching frequency/rated load:	15 min <sup>-1</sup>
Mechanical life:	2x 10 <sup>7</sup>
Electrical life AC1:	5x 10 <sup>4</sup>
Output indication:	6x yellow LED

#### Communication

Installation BUS:	BUS
-------------------	-----

#### Power supply

Supply voltage/tolerance:	27 V DC, -20/+10 %
Dissipated power:	max. 9 W
Rated current:	60 mA (at 27 V DC), from BUS
Status indication unit:	green LED RUN

#### Connection

Terminal:	max. 2.5 mm <sup>2</sup> /1.5 mm <sup>2</sup> with sleeve
-----------	---

#### Operating conditions

Air humidity:	max. 80%
Operating temperature:	-20 to +55 °C
Storing temperature:	-30 to +70 °C
Protection degree:	IP20 device, IP40 mounting in the switchboard
Overvoltage category:	II.
Pollution degree:	2
Operation position:	any
Installation:	switchboard on DIN rail EN 60715
Design:	3-MODULE

#### Dimensions and weight

Dimensions:	90 x 52 x 65 mm
Weight:	160 g

- The actuator is designed for switching up to six various appliances and loads with potentialless contact.
- SA3-06M is a switching actuator contains 6 independent relays with changeover potentialless contacts.
- Maximum load per contact is 8 A/2000 VA/AC1.
- Each of six output contacts are individually controllable and addressable.
- The relays are divided into two groups, the group of four relays on the bottom terminal switches the common potential, a pair of relays on top of the terminal switches the second common potential.
- The actuator is suitable for operating discontinuously controlled thermo drives in the distributor of floor heating.
- LEDs on the front panel signals the status of each output.
- Contact status of each relay can be changed separately and manually by control buttons on a front panel.
- SA3-06M is normally supplied in the option AgSnO<sub>2</sub> contact material.
- SA3-06M in 3-MODULE version is designed for mounting into a switchboard/DIN rail EN60715.

### Connection

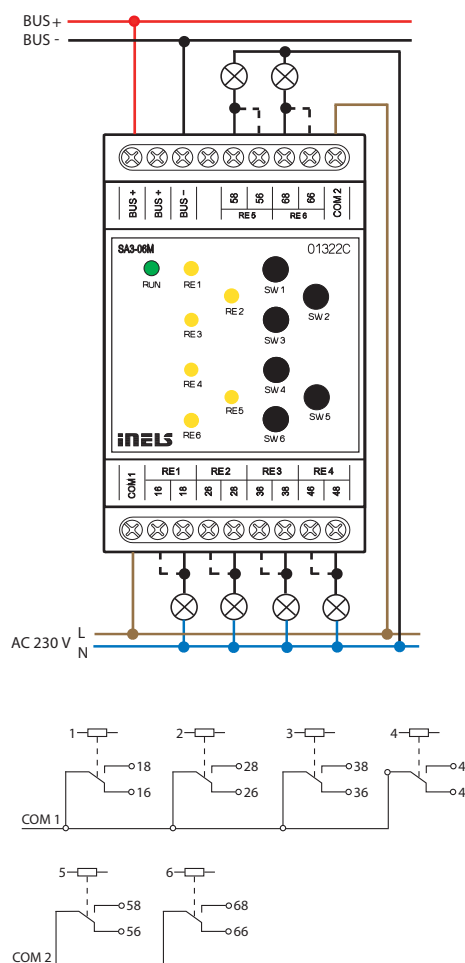



EAN code  
 SA3-012M: 8595188132466  
 SA3-012M/120V: 8595188133029

**Technical parameters** SA3-012M SA3-012M/120V

Outputs	
Output:	12x switching 8 A/AC1
Switched voltage:	250 V AC, 24 V DC
Switched output:	2000 VA/AC1, 192 W/DC
Peak current:	10 A
Output relays separated from all internal circuits:	reinforced insulation (Cat. II surges by EN 60664-1)
Isolation between relay outputs COM1, COM2 and COM3:	reinforced insulation (Cat. II surges by EN 60664-1)
Isolates. voltage open relay contact:	1 kV
Max. current of one common terminal:	16 A
Minimal switched current:	100 mA/10 V DC
Switching frequency without load:	300 min <sup>-1</sup>
Switching frequency with rated load:	15 min <sup>-1</sup>
Mechanical life:	1x 10 <sup>7</sup>
Electrical life AC1:	1x 10 <sup>5</sup>
Output indication:	12 x yellow LED
Communication	
Installation BUS:	BUS
The installation BUS is separated from all internal circuits:	reinforced insulation (Cat. II surges by EN 60664-1)
Status indication unit:	green LED RUN
Power supply	
Voltage of BUS/tolerance/nominal current:	27 V DC, -20/+10 %, 5 mA
Supply voltage of power section (relay) tolerance/nominal current:	AC 230 V (50 Hz), -15/+10 %, 20 mA      AC 120 V (60 Hz), -15/+10 %, 40 mA
Dissipated power:	max. 6 W      max. 5 W
Connection	
Terminal:	max. 2.5 mm <sup>2</sup> /1.5 mm <sup>2</sup> with sleeve
Operating conditions	
Operating temperature:	-20 to +55 °C
Storing temperature:	-30 to +70 °C
Protection degree:	IP20 device, IP40 mounting in the switchboard
Overvoltage category:	II.
Pollution degree:	2
Operating position:	any
Installation:	switchboard on DIN rail EN 60715
Design:	6-MODULE
Dimensions and weight	
Dimensions:	90 x 105 x 65 mm
Weight:	310 g

- The actuator is designed for switching twelve various appliances and loads with potentialless contact.
- SA3-012M is a switching actuator containing 12 independent relays with NO potentialless contacts, with the fact that switches the same potential.
- Maximal loadability of contacts is 8 A/2000 VA/AC1.
- Each of the twelve output contacts are individually controllable and addressable.
- Actuator SA3-012M is powered by an AC voltage 230 V. The unit SA3-012M/120 V is powered by AC voltage 120 V AC.
- BUS is galvanically separated from the internal circuits of unit.
- LED on front panel signalizes state of each output.
- Contact status of each relay can be changed separately and manually by control buttons on a front panel.
- SA3-012M is normally supplied in the option AgSnO<sub>2</sub> contact material.
- SA3-012M in design 6-MODULE is designed to be mounted into a switchboard, onto DIN rail EN60715.

**Connection**

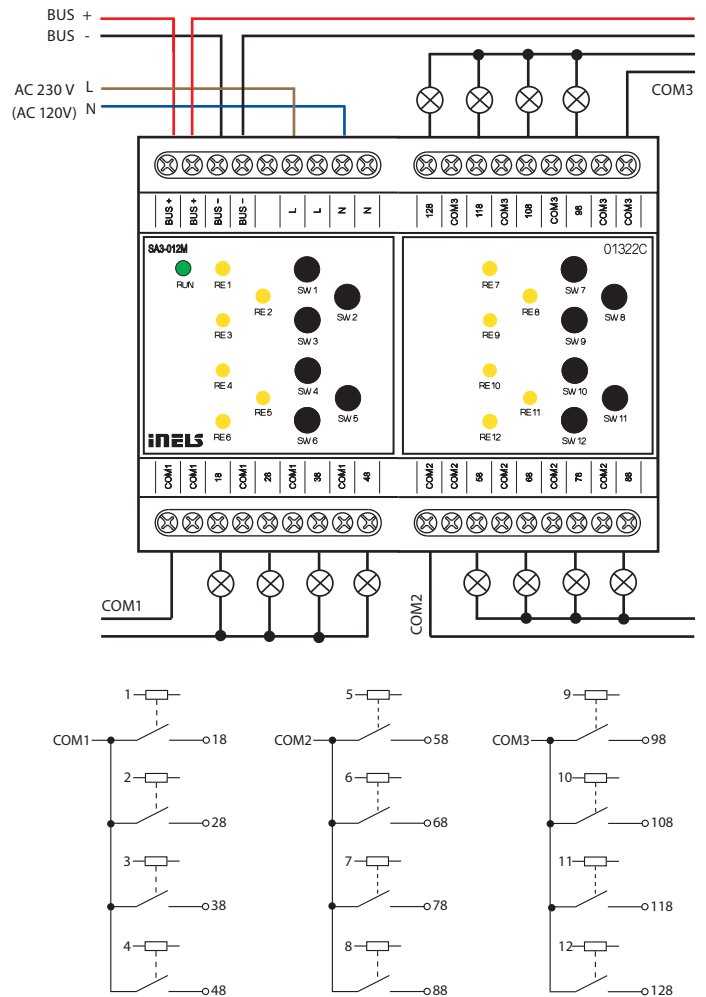

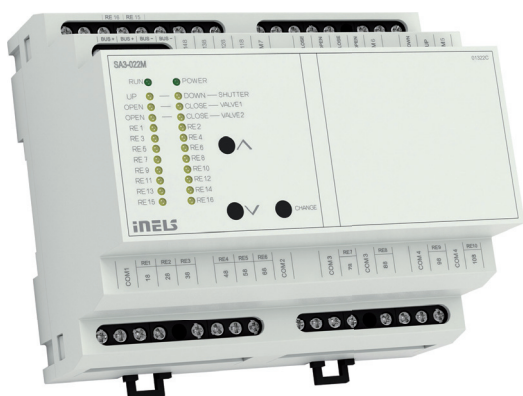

EAN code  
SA3-022M: 8595188135269

### Technical parameters

### SA3-022M

#### Outputs

Output indication:	yellow LED
Output relays separated from all internal circuits:	reinforced insulation (Cat. II surges by EN 60664-1)
Insulation between COM potentials:	reinforced insulation (Cat. II surges by EN 60664-1)
Isolates. voltage open relay contact:	1 kV
<b>SSR (Electronic Relay):</b>	4x switching (VALVE1–VALVE2)
Switching voltage:	20 - 240 V AC
Switching output:	480 VA
Surge current:	20 A, $t \leq 16$ ms
<b>Relay 6A:</b>	12x switching (RE1 - RE6, RE11 - RE16), 1x HW block changeover (OUT1, OUT2)
Switching voltage:	250 V AC, 24 V DC
Switching output:	1500 VA/AC1; 300 VA/AC15; 180 W/DC, AC3
Minimum switching load:	500 mW (12 V/10 mA)
Mechanical life:	$10 \times 10^6$
Electrical life AC1:	$6 \times 10^4$
<b>Relay 10A:</b>	4x switching (RE7 - RE10)
Switching voltage:	250 V AC, 24 V DC
Switching output:	2500 VA/AC1, 240 W/DC
Surge current:	30 A max. 4 s at 10%
Minimal switched current:	100 mA
Switching frequency without load:	$1200 \text{ min}^{-1}$
Switching frequency with rated load:	$6 \text{ min}^{-1}$
Mechanical life:	$3 \times 10^7$
Electrical life AC1:	$0.7 \times 10^5$
<b>Communication</b>	
Installation BUS:	BUS
Unit status indication:	green LED POWER
<b>Power supply</b>	
Supply voltage/tolerance:	27 V DC, -20/+10 %
Dissipated power:	max. 3 W
Rated current:	100 mA (at 27 V DC), from BUS
Power status indication:	green LED RUN
<b>Connection</b>	
Terminal:	max. 2.5 mm <sup>2</sup> /1.5 mm <sup>2</sup> with sleeve
<b>Operating conditions</b>	
Operating temperature:	-20 to +55 °C
Storing temperature:	-30 to +70 °C
Protection degree:	IP20 device, IP40 mounting in the switchboard
Overvoltage category:	II.
Pollution degree:	2
Operating position:	any
Installation:	switchboard on DIN rail EN 60715
Design:	6-MODULE
<b>Dimensions and weight</b>	
Dimensions:	90 x 105 x 65 mm
Weight:	307 g

- Equipped with 22 relay outputs (of which 1x changeover contact – roller blinds, blinds).
- Switch lighting and socket circuits (6 A and 10 A relay) with common potential at the "COMx" terminal.
- Control of roller blinds, blinds (24 - 230 V AC/DC).
- Relay control of the fan coil unit - heating/cooling, 3 fan speeds (24 - 230 V AC/DC).
- Connection to BUS, communication with CU3.
- The front panel LEDs indicate the status of each output.
- SA3-022M in design 6-MODULE is designed to be mounted into a switchboard, onto DIN rail EN60715.

### Connection

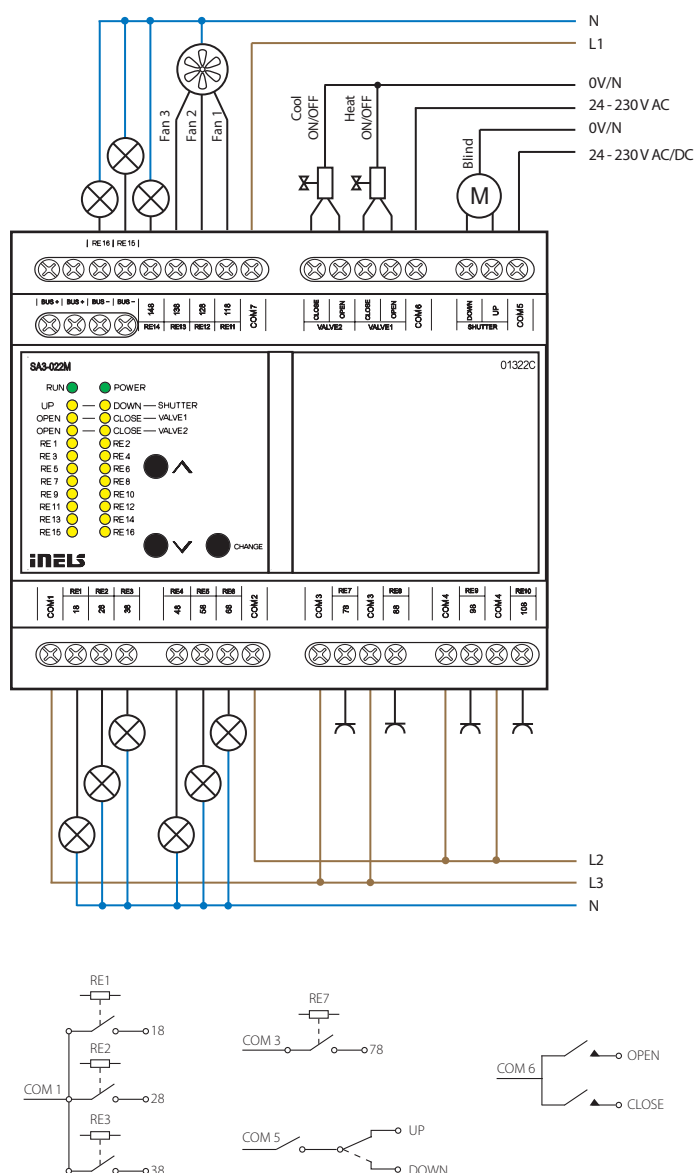

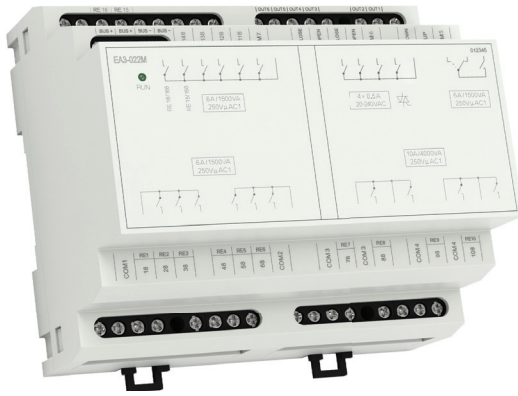

EAN code

EA3-022M: 8595188135238

Technical parameters

EA3-022M

Outputs

Output relays separated from all internal circuits:	reinforced insulation (Cat. II surges by EN 60664-1)
Insulation between COM potentials:	reinforced insulation (Cat. II surges by EN 60664-1)
Isolates. voltage open relay contact:	1 kV
SSR (Electronic Relay):	4x switching (VALVE1-VALVE2)
Switching voltage:	20 - 240 V AC
Switching output:	480 VA
Surge current:	20 A, t ≤ 16 ms
Relay 6 A:	12x switching (RE1 - RE6, RE11 - RE16), 1x HW block changeover (OUT1, OUT2)
Switching voltage:	250 V AC, 24 V DC
Switching output:	1500 VA/AC1; 300 VA/AC15; 180 W/DC, AC3
Minimum switching load:	500 mW (12 V/10 mA)
Mechanical life:	10x10 <sup>6</sup>
Electrical life AC1:	6x10 <sup>4</sup>
Relay 10 A:	4x switching (RE7 - RE10)
Switching voltage:	250 V AC, 24 V DC
Switching output:	2500 VA/AC1, 240 W/DC
Surge current:	30 A max. 4 s at 10 %
Minimal switched current:	100 mA
Switching frequency without load:	1200 min <sup>-1</sup>
Switching frequency with rated load:	6 min <sup>-1</sup>
Mechanical life:	3x 10 <sup>7</sup>
Electrical life AC1:	0.7x 10 <sup>5</sup>

Communication

Installation BUS:	BUS
Unit status indication:	green LED RUN

Power supply

Supply voltage/tolerance:	27 V DC, -20/+10 %
Dissipated power:	max. 2 W
Rated current:	100 mA (at 27 V DC), from BUS

Connection

Terminal:	max. 2.5 mm <sup>2</sup> /1.5 mm <sup>2</sup> with sleeve
-----------	---

Operating conditions

Operating temperature:	-20 to +55 °C
Storing temperature:	-30 to +70 °C
Protection degree:	IP20 device, IP40 mounting in the switchboard
Overvoltage category:	II.
Pollution degree:	2
Operating position:	any
Installation:	switchboard on DIN rail EN 60715
Design:	6-MODULE

Dimensions and weight

Dimensions:	90 x 105 x 65 mm
Weight:	337 g

- Equipped with 22 relay outputs (of which 1x changeover contact – roller blinds, blinds).
- Switch lighting and socket circuits (6 A and 10 A relay) with common potential at the "COMx" terminal.
- Control of roller blinds, blinds (24 - 230 V AC/DC).
- Relay control of the fan coil unit - heating/cooling, 3 fan speeds (24 - 230 V AC/DC).
- Connection to BUS, communication with CU3.
- EA3-022M in design 6-MODULE is designed to be mounted into a switchboard, onto DIN rail EN60715.

Connection

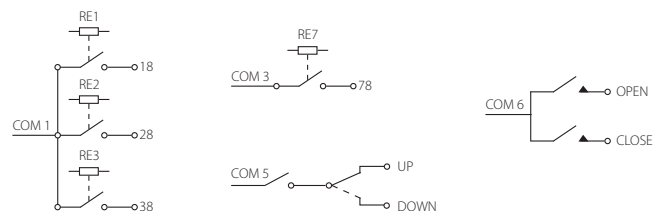
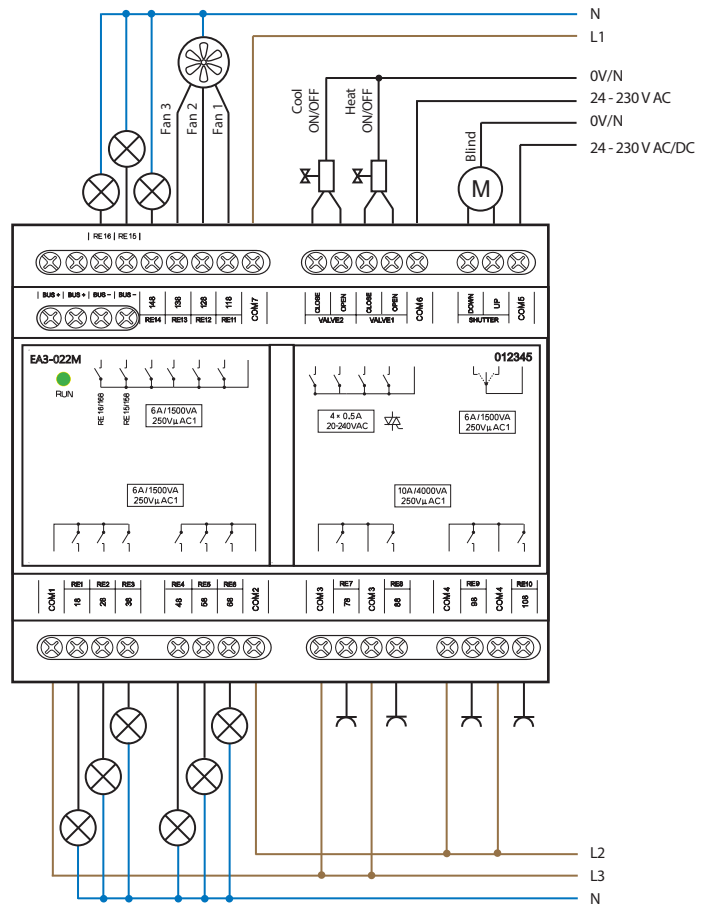



Dimming actuators

— dimm

— ing

— actuator



EAN code  
DA3-22M: 8595188132626  
DA3-22M/120V: 8595188133036

Technical parameters	DA3-22M	DA3-22M/120V
----------------------	---------	--------------

#### Inputs

Input:	2x inputs, switching potential L*
Temperature measuring:	YES, input for external thermo sensor TC/TZ
Scope and accuracy of temp. measurement:	-20 to +120 °C; 0.5 °C from the range
Number of control buttons:	2x buttons 4x potentiometers on front panel

#### Outputs

Output:	2x contactless outputs, 2x MOSFET
Load type:	resistive, inductive, capacitive**, LED, ESL
Isolation BUS separated from all internal circuits:	reinforced insulation (Cat. II surges by EN 60664-1)
Isolation voltage between particular power:	max. 500 V AC
Minimal controlled load:	10 VA
Maximal controlled load:	400 VA for each channel   200 VA for each channel
Output indication ON/OFF:	2x yellow LED
Device protection:	thermal/short-term overload/ long-term overload

#### Communication

Installation BUS:	BUS
-------------------	-----

#### Power supply

Supply voltage by BUS/ tolerance:	27 V DC, -20/+10 %	
Rated current:	5 mA (at 27 V DC), from BUS	
Status indication unit:	green LED RUN	
Supply voltage for power section/tolerance:	AC 230 V (50 Hz), -15/+10 %	AC 120 V (60 Hz), -15/+10 %
Dissipated power:	max. 13 W	max. 7.5 W

#### Connection

Terminal:	max. 2.5 mm <sup>2</sup> /1.5 mm <sup>2</sup> with sleeve
-----------	---

#### Operating conditions

Air humidity:	max. 80 %
Operating temperature:	-20 to +35 °C
Storing temperature:	-30 to +70 °C
Protection degree:	IP20 device, IP40 mounting in the switchboard
Overvoltage category:	II.
Pollution degree:	2
Operating position:	vertical
Installation:	switchboard on DIN rail EN 60715
Design:	3-MODULE

#### Dimensions and weight

Dimensions:	90 x 52 x 65 mm
Weight:	170 g

\* The inputs are not galvanically isolated from the supply voltage.

\*\* **Attention:** It is not allowed to connect loads of inductive and capacitive character, at the same time.

⚠ Input is connected to the mains voltage potential.

- DA3-22M is a universal dimming 2-fold actuator enabling control of brightness intensity of dimmable light sources of the type ESL, LED and RLC with power supply 230 V.
- DA3-22M has two MOSFET controlled outputs 230 V AC, maximum load is 2x 400 VA.
- Option of connecting an external temperature sensor.
- Each output channel is independently controllable and addressable.
- Type of light source is set by a switch on the front panel.
- By setting the min. brightness potentiometer on the front panel, flashing of different types of light sources is eliminated.
- DA3-22M is equipped with two inputs 230 V AC, which can be controlled by mechanical switches (buttons, relays). Inputs are galvanically connected to potential L, which is permanently at the terminals IN1 and IN2.
- By clicking on buttons on the front panel you can manually switch on or off the corresponding output.
- Electronic overcurrent and thermal protection - switch off output in case of overload short circuit and overheating.
- The power supply (potential L) must be protected by a protective element corresponding to the power input of the connected load, e.g. a safety fuse.
- During installation, it is necessary to leave on each side of the actuator at least half the module space for better cooling.
- DA3-22M in 3-MODULE version is designed for mounting into a switchboard on DIN rail EN60715.

#### Connection

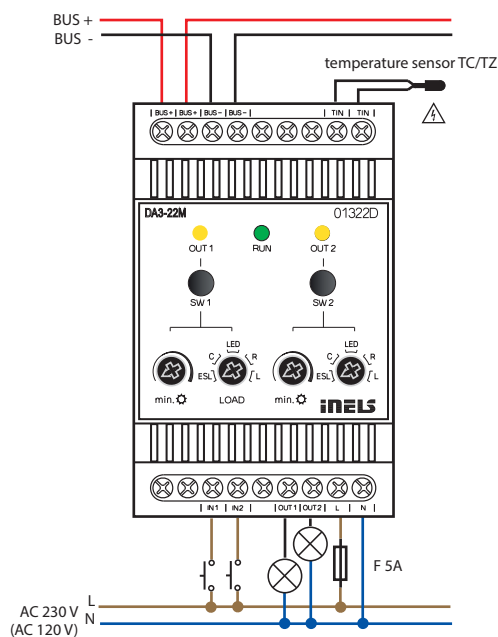

#### Types of connectable loads

type of source	symbol	description
R resistive		ordinary light bulb, halogen lamp
L inductive		coiled transformer for low-voltage halogen lamps
C capacitive		electronic transformer for low-voltage halogen lamps
LED		LED lamps and LED light sources, 230 V
ESL		dimmable energy-saving fluorescent tubes



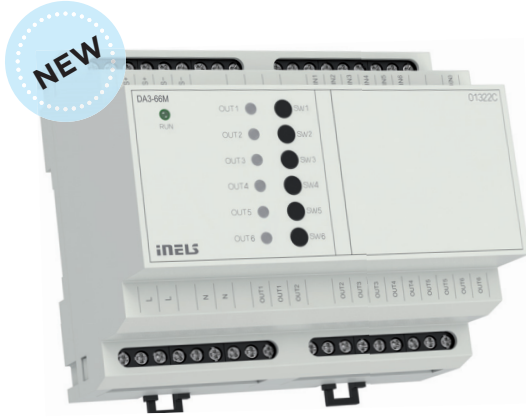

NEW

EAN code  
DA3-66M /230: 8595188182065  
DA3-66M /120: 8595188174459

**Technical parameters**      DA3-66M/230V      DA3-66M/120V

Inputs	
Input:	6x contactless outputs, 2x MOSFET / channel
Load type:	resistive, inductive, capacitive**, LED, ESL
Isolation BUS separated from all internal circuits and outputs:	reinforced insulation (Cat. II surges by EN 60664-1)
Insulation voltage between units power outputs:	max. 500 V AC
Minimal controlled load:	10 VA
Maximal controlled load:	DA3-66M / 230V: 150 VA for each channel DA3-66M / 120V: 75 VA for each channel possibility of parallel connection of outputs
Inputs:	6x galvanically separated
Input voltage:	20–230 AC(50–60 Hz)/DC
Isolation voltage:	between inputs max. 230 VAC/DC (basic insulation) to all other internal circuits: reinforced insulation: overvoltage category II
Maximum cable length:	50 m
Glow plug connection:	no
Output indication ON/OFF:	6x yellow LED
Device protection:	thermal/short-term overload/ long-term overload

Communication	
Installation BUS:	BUS
Power supply	
Supply voltage by BUS/ tolerance:	27 V DC, -20/+10 %
Rated current:	100 mA (at 27 V DC), from BUS
Status indication unit:	green LED RUN
Supply voltage for power section/tolerance:	AC 230 V (50 Hz), AC 120 V (60 Hz), -15/+10 %      -15/+10 %

Connection	
Terminal:	max. 2.5 mm <sup>2</sup> /1.5 mm <sup>2</sup> with sleeve

Operating conditions	
Air humidity:	max. 80 %
Operating temperature:	-20 to +50 °C
Storing temperature:	-30 to +70 °C
Protection degree:	IP20 device, IP40 mounting in the switchboard
Overvoltage category:	II.
Pollution degree:	2
Operating position:	vertical
Installation:	switchboard on DIN rail EN 60715
Design:	6-MODULE

Dimensions and weight	
Dimensions:	90 x 105 x 65 mm
Weight:	320 g

\* **Attention:** It is not allowed to connect loads of inductive and capacitive character, at the same time.

- DA3-66M is a universal dimming 6-channels actuator, which is used to control the brightness of dimmable light sources such as ESL, LED and RLC with 230 V power supply.
- The DA3-66M has 6 semiconductor controlled 230 V AC outputs. The maximum possible load is 150 VA for each channel.
- The individual outputs of the dimmer can be connected in parallel and thus increase the maximum output load at the expense of the number of outputs.
- Each output channel is independently controllable and addressable.
- The type of light source is set with a switch on the front of the device.
- By setting the min, the brightness potentiometer on the front of the device eliminates flickering of different types of light sources.
- Min. brightness and type of load is performed using SW IDM.
- Use the control buttons on the front panel to manually control the output.
- The actuator is equipped with electronic overcurrent and thermal protection, which switches off the output in case of overload, short circuit, overheating.
- During installation, it is necessary to leave at least half of the module space free on each side of the actuator for better cooling.
- DA3-66M is in 6-MODULE version and is intended for mounting in a switchboard on DIN rail EN60715.
- The dimmer has 6 galvanically separated inputs which can be used both to control the dimmer and as a binary input to the INELS system.
- The the device supply (potential L) must be protected with a safety device corresponding to the power input of the connected load, e.g. with a quick-release fuse.

**Connection**

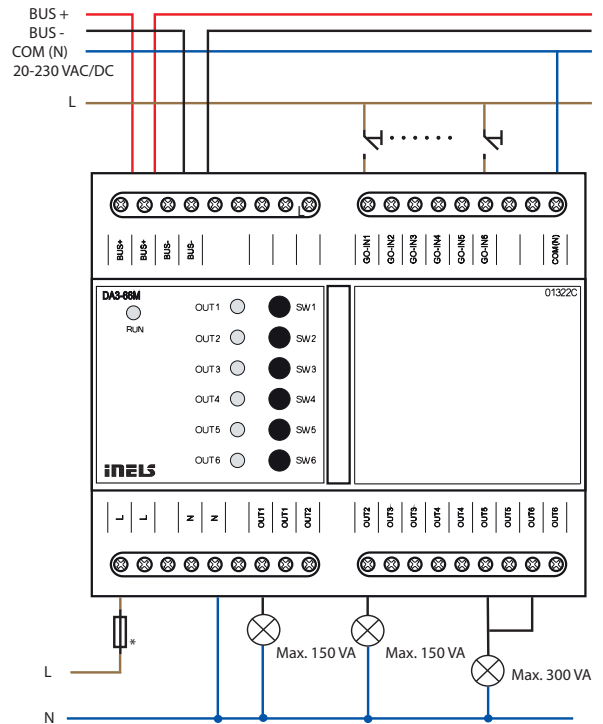

**Types of connectable loads**

type of source	symbol	description
R resistive		ordinary light bulb, halogen lamp
L inductive		coiled transformer for low-voltage halogen lamps
C capacitive		electronic transformer for low-voltage halogen lamps
LED		LED lamps and LED light sources, 230 V
ESL		dimmable energy-saving fluorescent tubes



EAN code  
LBC3-02M: 8595188132688

### Technical parameters

### LBC3-02M

#### Inputs

Number of control buttons: 2 buttons on the front panel

#### Outputs

Output:	2x 0(1)-10 V/10 mA 2x changeover 16 A/AC1
Switching voltage:	250 V AC, 24 V DC
Switching capacity:	4 000 VA/AC1, 384 W/DC
Peak current:	30 A; max. 4 s. at duty cycle 10%
Insulation voltage between individual relay outputs RE1aRE2 and internal circuits:	4 kV reinforced insulation (Cat. II surges by EN 60664-1)
Isolates. voltage open relay contact:	1 kV
Minimal switched current:	100 mA
Frequency of switching/no load:	1 200 min <sup>-1</sup>
Frequency of switching/rat. load:	6 min <sup>-1</sup>
Mechanical life:	3x 10 <sup>7</sup>
Electrical life AC1:	0.7x 10 <sup>5</sup>
Output indication:	2x yellow LED

#### Communication

Installation BUS: BUS

#### Power supply

Supply voltage/tolerance:	27 V DC, -20/+10 %
Dissipated power:	max. 2 W
Rated current:	60 mA (at 27 V DC), from BUS
Status indication unit:	green LED RUN

#### Connection

Terminal: max. 2.5 mm<sup>2</sup>/1.5 mm<sup>2</sup> with sleeve

#### Operating conditions

Air humidity:	max. 80 %
Operating temperature:	-20 to +55 °C
Storing temperature:	-30 to +70 °C
Protection degree:	IP20 device, IP40 mounting in the switchboard
Overvoltage category:	II.
Pollution degree:	2
Operating position:	any
Installation:	switchboard on DIN rail EN 60715
Design:	3-MODULE

#### Dimensions and weight

Dimensions:	90 x 52 x 65 mm
Weight:	134 g

- LBC3-02M is an analog 2-channels actuator designed to control dimmable ballasts of fluorescent lamps or other light sources controlled by signal 0(1) - 10 V DC.
- In the iDM3, it is possible to set the output mode 0(1) - 10 V DC.
- During analog voltage output (0)1-10 V DC control, relay contact automatically switches power supply to light ballast (0% = relay OFF, 1-100% = relay ON)
- LBC3-02M contains 2 independent analog voltage outputs (0)1-10 V DC and their dependents 2 relays with potential-free contact.
- Maximum contacts load 16 A/4000 VA/AC1.
- Each of 2-channels is separately controllable and addressable.
- LEDs on front panel signals status of each channel.
- With control buttons on the front panel, it is possible to change the status of each channel separately.
- LBC3-02M in 3-MODULE version is designed for mounting into a switchboard/ DIN rail EN60715.

### Connection

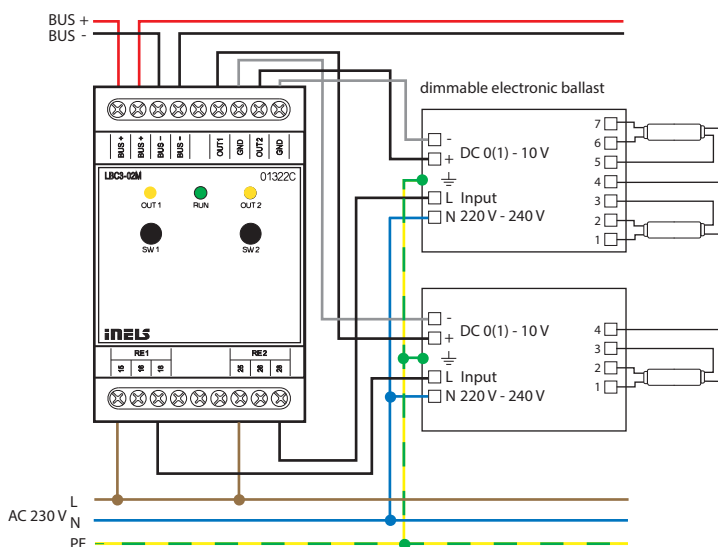

Input units



The diagram shows a large blue rounded rectangle representing a neural network layer. Three horizontal white lines extend from the left edge of the rectangle to the right. The top line is labeled 'in', the middle line is labeled 'pout', and the bottom line is labeled 'units'. The labels are in a white, lowercase, sans-serif font.

in

pout

units

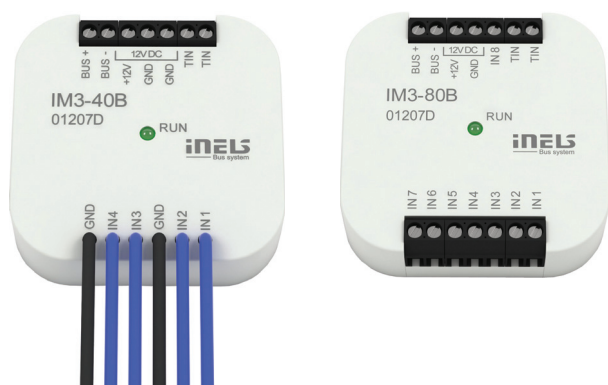

EAN code  
 IM3-40B: 8595188132312  
 IM3-80B: 8595188132329

Technical parameters	IM3-40B	IM3-80B
<b>Inputs</b>		
Input:	4x* IN1, IN2**	8x* IN1- IN5**
Max. frequency pulse reading:	20 Hz	
Temperature measuring:	yes, input for external thermo sensor TC/TZ	
Range/accuracy of thermomeasuring:	-20 to +120 °C/0.5 °C from the range	
<b>Outputs</b>		
Output voltage/current:	12 V DC/75 mA, for supplying EZS sensors	
<b>Communication</b>		
Installation BUS:	BUS	
Status indication unit:	green LED RUN	
<b>Power supply</b>		
Supply voltage/tolerance:	27 V DC, -20/+10 %	
Dissipated power:	max. 1 W	
Rated current:	20 mA (at 27 V DC), from BUS	
Rated current of unit for full load on output 12 V DC:	60 mA	100 mA
<b>Connection</b>		
Terminal:	0.5-1 mm <sup>2</sup>	
Inputs:	6x conductors CY length 90 mm	x
<b>Operating conditions</b>		
Operating temperature:	-20 to +55 °C	
Storing temperature:	-30 to +70 °C	
Protection degree:	IP30	
Overvoltage category:	II.	
Pollution degree:	2	
Operating position:	any	
Installation:	into installation box	
<b>Dimensions and weight</b>		
Dimensions:	49 x 49 x 13 mm	
Weight:	32 g	27 g

\* NO or NC against GND(-)  
 \*\* are balanced inputs

- Binary input units IM3-40B and IM3-80B are used for connection of 4 or 8 devices with potential-less contacts (switches, buttons, switches of other design, PIR detectors, fire and gas detectors, etc.).
- Part of the inputs can be used as a balanced for alarm detectors:
  - IM3-40B – inputs IN1, IN2
  - IM3-80B – inputs IN1 – IN5
- Contacts of external devices connected to the inputs of the unit can be NO or NC - input parameters are configured in the software iDM3.
- Within the internal ESS configured in the iDM3 software, inputs must be set to balance or double balance.
- The units generate a supply voltage of 12 V DC/75 mA for powering external intrusion detectors, so they can power PIR detectors, fire and gas detectors.
- Active use 12 V DC output for powering detectors increases the nominal consumption of units from BUS (see technical data).
- The units can be used for counting pulses of energy meters with pulse output.
- The units are equipped with a temperature input for connecting an external two-wire temperature sensor TC/TZ (see accessories).
- IM3-40B, IM3-80B in case type B are designed for mounting into a installation box.

Connection

IM3-40B

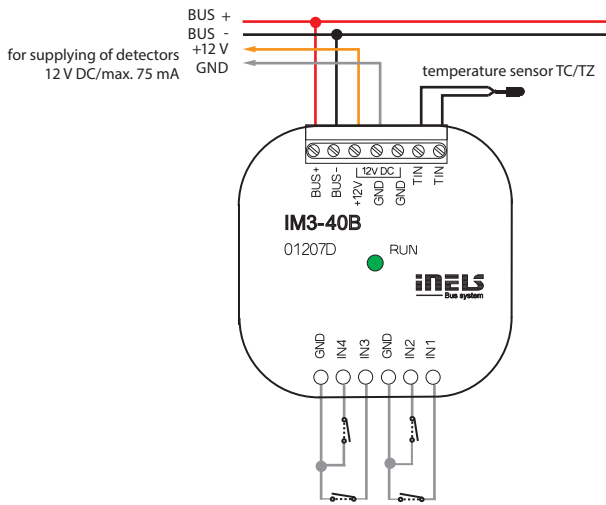

IM3-80B

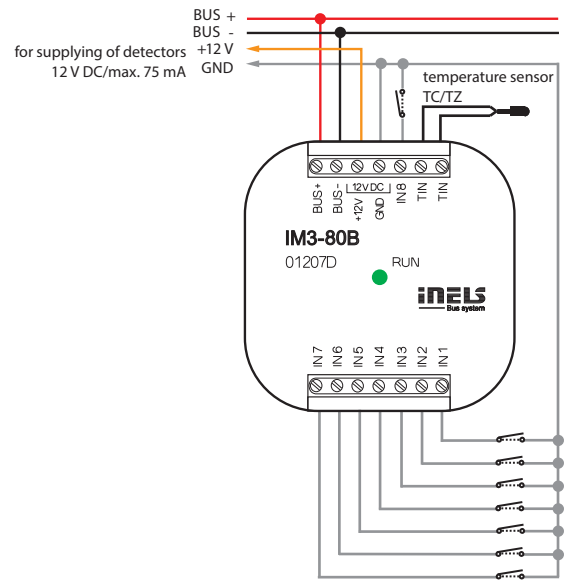

Balanced input

Simple:

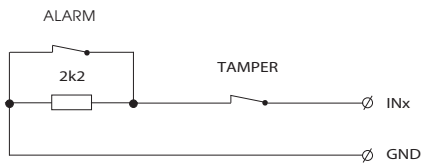

Double:

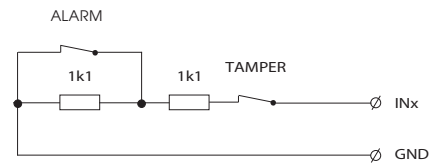



EAN code  
T13-40B: 8595188132695

### Technical parameters

### T13-40B

#### Input

Temperature input for temperature measuring:	4x inputs for external thermo sensor*
Temperature measurement range:	by type of sensor, prob from -50°C to 400°C
Converter resolution:	15 bit

#### Communication

Installation BUS:	BUS
Status indication unit:	green LED RUN

#### Power supply

Supply voltage/tolerance:	27 V DC, -20/+10 %
Dissipated power:	max. 1 W
Rated current:	20 mA (at 27 V DC), from BUS

#### Connection

Terminal:	0.5 mm <sup>2</sup> - 1 mm <sup>2</sup>
-----------	---

#### Operating conditions

Operating temperature:	-20 to +55 °C
Storing temperature:	-30 to +70 °C
Protection degree:	IP30
Overvoltage category:	II.
Pollution degree:	2
Operating position:	any
Installation:	into installation box

#### Dimensions and weight

Dimensions:	49 x 49 x 13 mm
Weight:	27 g

\*TC, TZ, Ni1000, Pt1000, Pt100, see accessories

### Connection options

#### 2-wire

- it is necessary to connect terminals TIN\_B and COM

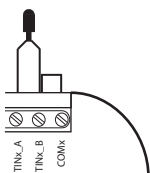

#### 3-wire

- connection of the sensor needs to be done according to the technical specifications

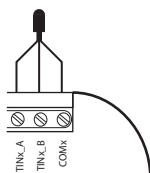

- The unit is designed for connection of up to four (T13-40B) external temperature sensors.
- Units range T13 support the connection of the following temperature sensors:
  - TC/TZ - 2-wire connections
  - Ni1000, Pt1000, Pt100 - 2-wire and 3-wire connections
- Used in when necessary to take temperatures from different places (for example large floor heating – diagonal layout of sensors, floor/space, indoor/outdoor temperature, technological device – boiler, solar heating etc.)
- Status of units indicated by green RUN LED on the front panel:
  - if the supply voltage is connected (units are powered via the BUS), but there is no communication with the master, RUN LED is lit continuously.
  - if the supply voltage is connected and the unit communicates via standard BUS, RUN LED flashes.
- T13-40B in version B is designed for mounting into an installation box.

### Connection

#### T13-40B

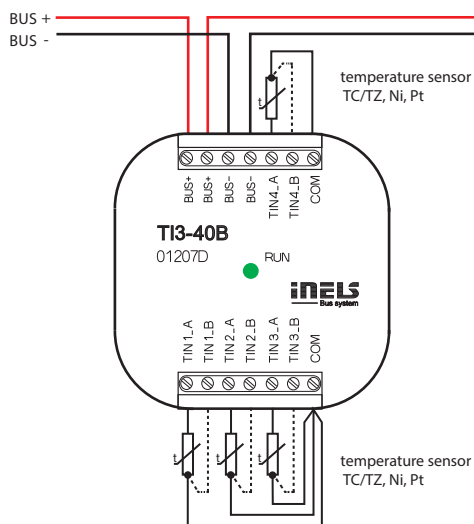



EAN code  
TI3-60M: 8595188132893

**Technical parameters** **TI3-60M**

Inputs	
Temperature input for temperature measuring:	6x input for external temperature sensor TC, TZ, Ni1000, Pt1000, Pt100 see accessories
Temperature measurement range:	by type of sensor, probe from -50°C to 400°C
Converter resolution:	15 bit
Indication of exceeding the range or interruption of the sensor:	6x red LED
Communication	
Installation BUS:	BUS
Status indication unit:	green LED RUN
Power supply	
Supply voltage/tolerance:	27 V DC, -20/+10 %
Dissipated power:	max. 1 W
Rated current:	45 mA (at 27 V DC), from BUS
Connection	
Terminal:	max. 2.5 mm <sup>2</sup> /1.5 mm <sup>2</sup> with sleeve
Operating conditions	
Operating temperature:	-20 to +55 °C
Storing temperature:	-30 to +70 °C
Protection degree:	IP20 device, IP40 mounting in the switchboard
Overvoltage category:	II.
Pollution degree:	2
Operating position:	any
Installation:	into a switchboard rail to DIN EN 60715
Design:	3-MODULE
Dimensions and weight	
Dimensions:	90 x 52 x 65 mm
Weight:	111 g

**Connection options**

2-wire  
- it is necessary to connect terminals TIN\_B and COM



3-wire  
- connection of the sensor needs to be done according to the technical specifications



- Unit TI3-60M is designed to connect up to six external temperature sensors.
- Units range TI3 support the connection of the following temperature sensors:
  - TC/TZ - 2-wire connections
  - Ni1000, Pt1000, Pt100 - 2-wire and 3-wire connections
- It is used in cases where it is necessary to read the temperature, eg floor/room, indoor/outdoor temperature, process equipment - boiler, solar heating, etc.
- Unit status is indicated by green RUN LED on the front panel:
  - if the supply voltage is connected (the unit is powered via the BUS), but there is no communication with the master, RUN LED is lit continuously.
  - if the supply voltage is connected and the unit communicates via standard BUS, RUN LED flashes.
- The status on individual temperature inputs is indicated by the relevant red LED on the front panel:
  - LIT - temperature sensor disconnection
  - FLASHES - exceeding of the temperature range
  - UNLIT - ok
- TI3-60M in 3-MODULE is designed for switchboard mounting on DIN rail EN60715.

**Connection**

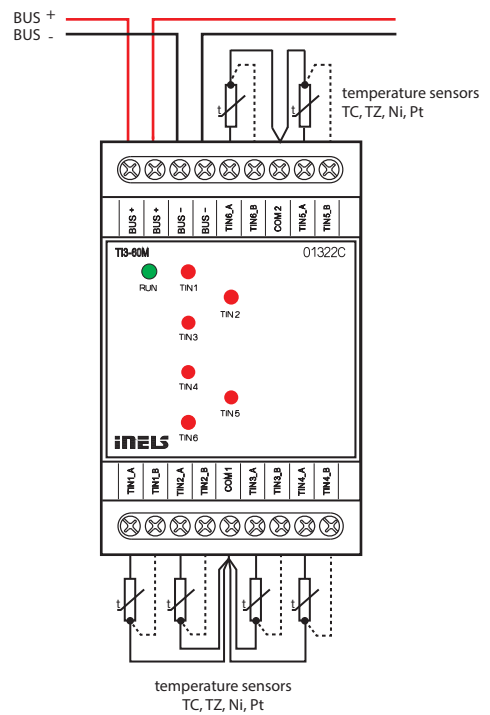



EAN code

IM3-140M: 8595188132459

**Technical parameters****IM3-140M****Inputs**

Input: 14x NO or NC against GND (-)  
IN1 - IN7 - are balanced inputs

Max. frequency pulse reading: 20 Hz

**Outputs**

Output (power supply 12 V for sensors): 12 V DC/150 mA

**Communication**

Installation BUS: BUS  
Data transfer indication: green LED

**Power supply**

Supply voltage/tolerance: 27 V DC, -20/+10 %  
Dissipated power: max. 1 W  
Rated current: 25 mA (at 27 V DC), from BUS  
Rated current for full load on output 12 V DC: 100 mA

**Connection**

Terminal: max. 2.5 mm<sup>2</sup>/1.5 mm<sup>2</sup> with sleeve

**Operating conditions**

Air humidity: max. 80 %  
Operating temperature: -20 to +55 °C  
Storing temperature: -30 to +70 °C  
Protection degree: IP20 device, IP40 mounting in the switchboard  
Overvoltage category: II.  
Pollution degree: 2  
Operating position: any  
Installation: into a switchboard rail to DIN EN 60715  
Design: 3-MODULE

**Dimensions and weight**

Dimensions: 90 x 52 x 65 mm  
Weight: 104 g

- Binary input unit IM3-140M is designed to connect up to 14 devices with potentialless contact (such as switches, buttons of other designs, fire and glass detectors and others).
- Inputs IN1 - IN7 can be balanced.
- Contacts of external devices connected to the inputs of the drive can be NO or NC - Input parameters are configured in the software iDM3.
- Inputs must be configured as balanced or double balanced - in an internal Electronic security system configured in iDM3 software.
- The unit generates a supply voltage of 12 V DC/150 mA for powering external detectors, so it can power PIR detectors, fire and gas detectors.
- Active use 12 V DC output for powering detectors increases the nominal consumption units from BUS (see technical data).
- The unit can be used for counting pulses of energy meters with pulse output.
- IM3-140M in 3-MODULE is designed for switchboard mounting on DIN rail EN60715.

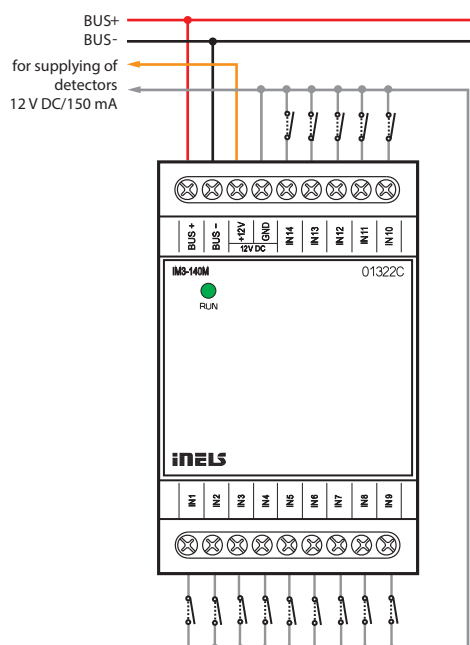
**Connection****Balanced input**

Simple:

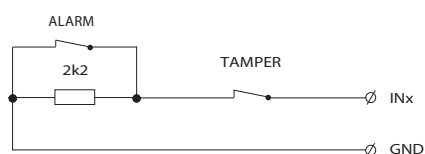

Double:

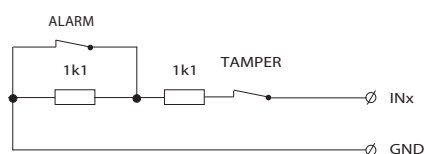



Combined units

com

bin

ed

units

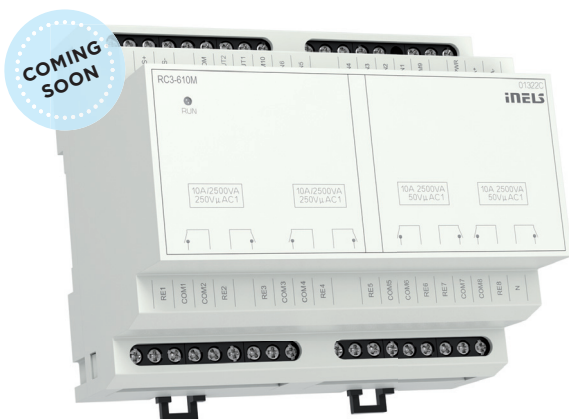

EAN code  
RC3-610M/DALI: 8595188181884

Technical parameters	RC3-610M/DALI
<b>Output</b>	
Output:	8x NO/switch 8 A/AC1
Switched voltage:	250 V AC1, 150 W/DC
Switched power:	2500 VA/AC1, 150 W/DC
Peak current:	10 A
Relay outputs separated from of all internal circuits:	reinforced insulation (Overvoltage cat. II according to EN 60664-1)
Isolation between relay outputs COM1, COM2, COM3 a COM4:	basic insulation (cat. overvoltage II according to EN 60664-1)
Isolation voltage of the open relay contact:	1 kV
Max. current through one common terminal:	16 A
Minimum switching current:	100 mA/10 V DC
Switching frequency without load:	300 min <sup>-1</sup>
Switching frequency nm. Loads:	15 min <sup>-1</sup>
Mechanical service life:	10 000 000
Electrical life AC1:	100 000
<b>Analog:</b>	
Analog outputs:	AO1, AO2
Voltage analogue. output/ max. current:	2x 0(1) - 10 V/10 mA
<b>Inputs</b>	
Input:	6x switching or inlaying against COM9 (-)
Max. pulse reading frequency:	20 Hz
Common conductor:	COM9
<b>Communication</b>	
<b>DALI</b>	
Output interface:	DALI (max. 32 ballasts - internal DALI source) DALI (max. 64 ballasts - external DALI source)
Internal DALI source:	clamps DALI PWR
<b>BUS</b>	
Installation bus:	BUS
Indication of unit status:	Green LED RUN
<b>Power</b>	
Supply voltage BUS/ tolerance/rated current:	27 V DC, -20/+10 %, 110 mA
Power dissipation:	3 W
<b>Connection</b>	
Terminal plate:	max. 2.5 mm <sup>2</sup> /1.5 mm <sup>2</sup> with core

\* adjacent COM terminals (COM1 and 2, COM3 and 4, COM5 and 6, COM7 and 8) must be at the same potential

\*\* input function is set during configuration

\*\*\* ACOM and COM9 terminals are at BUS potential

- The RC3-610M/DALI is an I/O actuator equipped with 6 binary inputs, of which 2 can be configured as temperature inputs and 8 independent relays with switching potential-free and potential contacts. It also includes two analog outputs 0(1)-10 V with a load capacity of up to 10 mA.
- Binary inputs RC3-610M/DALI are used for connecting up to 6 devices with a non-decimal contact (such as switches, switches, buttons of other design, EZS and EPS detectors and others).
- Temperature inputs support the connection of TC/TZ temperature sensors in a 2-wire connection for temperature sensing needs.
- The actuator is designed for switching up to eight different appliances and loads by relay output (potential-free contact).
- The maximum load capacity of the relay contacts is 10 A/2500 VA/AC1. Each of the output contacts is individually controllable. Relays are divided into four pairs, where each pair switches on its common potential.
- The DALI system BUS allows control of up to 32 independent DALI (Digital Addressable Lighting Interface) ballast addresses for fluorescent, LED and other luminaires.
- Analog outputs are considered for use with thermoregulation heads, air-conditioning ventilation flaps, various other dimmers or other devices with an analog control voltage of 0-10 V or 1-10 V.
- The parameters of all configurable inputs and outputs are set in the iNELS Designer & Manager configuration software environment, which is designed for Windows 7, 8 and 10 operating systems.
- RC3-610M/DALI in 6-MODULE version is designed for mounting into a switchboard on DIN rail EN60715.

Operating conditions	
Working temperature:	-20 to +55 °C
Storage temperature:	-30 to +70 °C
Degree of protection:	IP20 device, IP40 with cover in the control cabinet
Surge category:	II.
Degree of pollution:	2
Working position:	any
Installation:	to the control cabinet for DIN rail EN 60715
Design:	6-MODULE
Dimensions and weight	
Dimensions:	90 x 105 x 65 mm
Weight:	310 g

### Connection

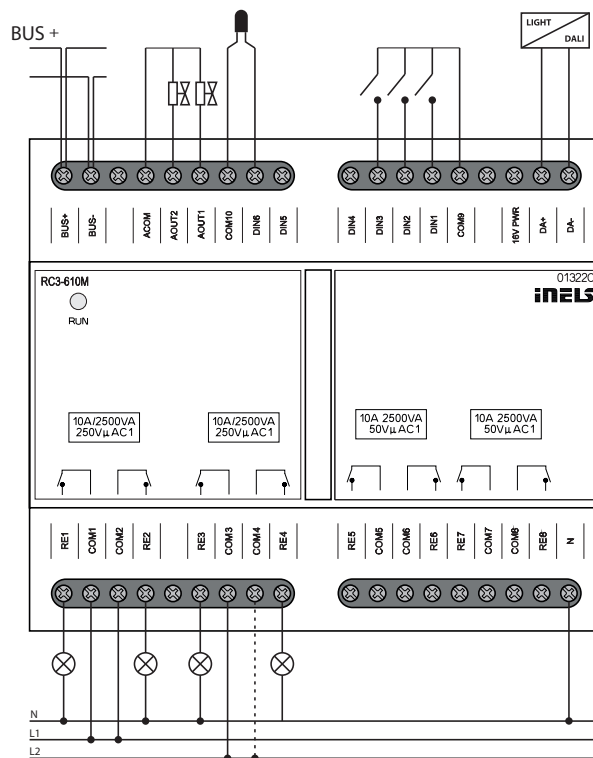

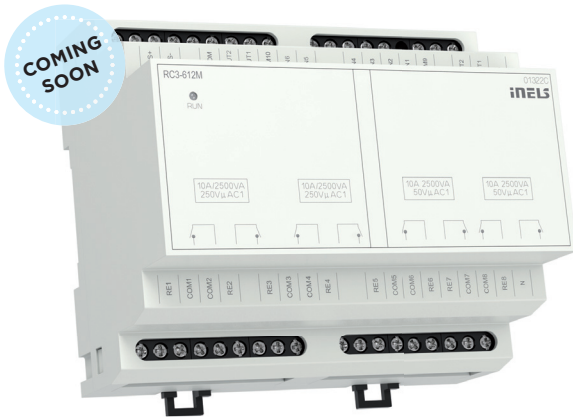

EAN code  
RC3-612M: 8595188181884

Technical parameters		RC3-612M
<b>Outputs</b>		
Output:	8x NO/switch 8 A/AC1	
Switched voltage:	250 V AC1, 150 W/DC	
Switched power:	2500 VA/AC1, 150 W/DC	
Peak current:	10 A	
Relay outputs separated from of all internal circuits:	reinforced insulation (Overvoltage cat. II according to EN 60664-1)	
Isolation between relay outputs COM1, COM2, COM3 a COM4:	reinforced insulation (Overvoltage cat. II according to EN 60664-1)	
Isolation voltage of the open relay contact:	1 kV	
Max. current once common clamp:	16 A	
Minimum switching current:	100 mA/10 V DC	
Switching frequency without load:	300 min <sup>-1</sup>	
Switching frequency nm. Loads:	15 min <sup>-1</sup>	
Mechanical service life:	10 000 000 op.	
Electrical life AC1:	100 000 op.	
<b>Analog</b>		
Analog outputs:	AO1, AO2	
Voltage analogue. output/ max. current:	2x 0(1) - 10 V/10 mA	
<b>Dimmer</b>		
Output:	2 contactless outputs, 2x MOSFET	
Type of load:	resistive, inductive and capacitive**, LED, ESL	
Insulation voltage between the unit force outputs:	max. 500 V AC	
Minimum output power:	10 VA	
Maximum output power:	150 VA for each channel	
Device protections:	thermal/short-term overload/ long-term overload	
<b>Inputs</b>		
Input:	6x switching or inlaying against COM9 (-)	
Max. pulse reading frequency:	20 Hz	
Common conductor:	COM9	
<b>BUS</b>		
Installation bus:	BUS	
Unit status indication:	Green LED RUN	
<b>Power</b>		
Supply voltage BUS/ tolerance/rated current:	27 V DC, -20/+10 %, 110 mA	
Power dissipation:	3 W	

\* adjacent COM terminals (COM1 and 2, COM3 and 4, COM5 and 6, COM7 and 8) must be at the same potential  
 \*\* input function is set during configuration  
 \*\*\* ACOM and COM9 terminals are at BUS potential

- The RC3-612M is an I/O actuator equipped with 6 binary inputs, of which 2 can be configured as temperature inputs and 8 independent relays with switching potential-free and potential-free contacts. It also includes two analog outputs 0(1)-10V with a load capacity of up to 10mA and two-phase dimmer channels.
- Binary inputs RC3-612M are used for connecting up to 6 devices with potential-free Contact (as are levers switches buttons Other Designs detectors EZS and EPS a other).
- Temperature inputs support the connection of TC/TZ temperature sensors in a 2-wire connection for temprature sensing needs.
- The actuator is designed for switching up to eight different appliances and loads by relay output (potential-free contact).
- The maximum load capacity of the relay contacts is 10 A/2500 VA/ AC1. Each of the output contacts is individually controllable. Relays are divided into four pairs, where each pair switches on its common potential.
- The two-channel phase dimmer allows dimming of resistive, capacitive and inductive loads up to 150VA per channel. The nature of the load is set in the output parameters when configuring the unit.
- Analog outputs are considered for use with thermoregulation heads, air-conditioning ventilation flaps, various other dimmers or other devices with an analog control voltage of 0-10V or 1-10V.
- The parameters of all configurable inputs and outputs are set in the iNELS Designer & Manager configuration software environment, which is designed for Windows 7, 8 and 10 operating systems.
- RC3-612M in 6-MODULE version is designed for mounting into a switchboard on DIN rail EN60715.

Connection	
Terminal plate:	max. 2.5 mm <sup>2</sup> /1.5 mm <sup>2</sup> with core
Operating conditions	
Working temperature:	-20 to +55 °C
Storage temperature:	-30 to +70 °C
Degree of protection:	IP20 device, IP40 with cover in the control cabinet
Surge category:	II.
Degree of pollution:	2
Working position:	any
Installation:	to the control cabinet for DIN rail EN 60715
Implementation:	6-MODULE
Dimensions and weight	
Dimensions:	90 x 105 x 65 mm
Weight:	360 g

**Connection**

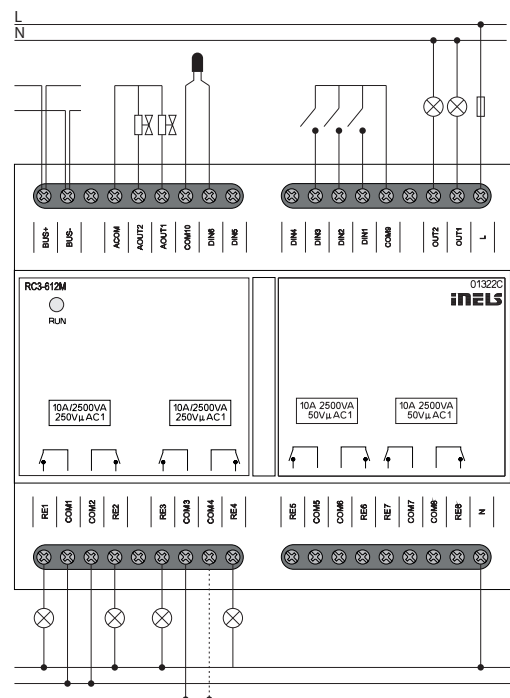

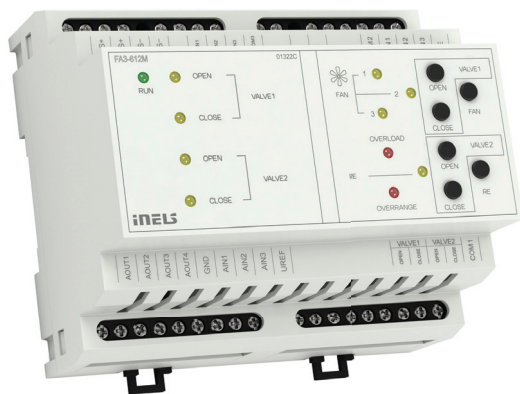

EAN code  
FA3-612M: 8595188135276

## Technical parameters

## FA3-612M

### Input

<b>Analog inputs:</b>	3x voltage, current or temperature input
Number of inputs:	3
Galv. separation from inner circuits:	no
Diagnostic:	indication red LED OVERRANGE (exceeding the range, interruption of a sensor or overload of Uref output)
Common terminal:	GND
Converter resolution:	14 bits
Input resistance	
- for voltage ranges:	approx. 150 kΩ
- for current ranges:	100 Ω
Types of inputs/measuring ranges*:	<b>Voltage (U):</b> 0 ÷ +10 V (U) ; 0 ÷ +2 V (U) <b>Current (I):</b> 0 ÷ +20 mA (I) ; 4 ÷ +20 mA (I) <b>temperature:</b> input at ext. temperature sensor TC, TZ, Ni1000**, Pt1000**, Pt100** see accessories/ according to used sensor from -30 °C to 250 °C

<b>Digital inputs:</b>	3x switching or expansion, positive logic (SINK)
Input voltage:	20 - 240 V AC (50 - 60 Hz)/DC
Galv. separation from internal circuits:	yes
Common lead:	GO COM3

### Outputs

<b>Analog:</b>	4x (A_OUT1 - A_OUT4)
Voltage analog. output/max. Current:	4x 0(1) - 10 V/10 mA
<b>Uref reference voltage outputs</b>	
Voltage/Current Uref:	10 V DC/100 mA
Output overload indication:	red LED OVERLOAD
<b>SSR (Electronic Relay):</b>	4x (VALVE1 - VALVE2)
Switching voltage:	20 - 240 V AC
Switching capacity:	480 VA
Peak current:	20 A, t ≤ 16 ms
Output indication:	yellow LED
<b>Relay 6A:</b>	4x (FAN1-FAN3, RE)
Switching voltage:	250 V AC, 24 V DC
Switching capacity:	1500 VA/AC1; 300 VA/AC15; 180 W/DC, AC3
Relay outputs separated from all internal circuits:	reinforced insulation (Cat. II surges by EN 60664-1)
Minimum switching load:	500 mW (12 V/10 mA)
Mechanical life:	10x10 <sup>6</sup>
Electrical life AC1:	6x10 <sup>4</sup>
Output indication:	yellow LED

### Communication

Installation BUS:	BUS
Status indication unit:	green LED RUN

### Power supply

Supply voltage/tolerance/ rated current:	27 V DC, -20/+10 %, 5 mA
Supply voltage of power section (relay) tolerance/ nominal current:	AC 230 V (50 Hz), -15/+10 %, 20 mA
Dissipated power:	max. 1 W

- FA3-612M is a unit (actuator) designed to control fan coil units using analogue/digital inputs and analog/relay outputs.
- Analog inputs for temperature, voltage or current measurement (Uref reference voltage can also be used).
- The digital inputs are galvanically isolated with positive logic (Sink) in the 24-230 V AC/DC voltage range.
- Analog outputs 0-10 V.
- Connection to the installation BUS.
- Buttons for closing/opening the valve, fan and heating relay.
- The LEDs on the front panel indicate FAN, RE, VALVE1, VALVE2, OVER-RANGE, and OVERLOAD status.
- FA3-612M in 6-MODULE version is designed for mounting into a switchboard, on DIN rail EN60715.

### Connection

Terminal:	max. 2.5 mm <sup>2</sup> /1.5 mm <sup>2</sup> with sleeve
-----------	---

### Operating conditions

Operating temperature:	-20 to +55 °C
Storing temperature:	-30 to +70 °C
Protection degree:	IP20 device, IP40 mounting in the switchboard
Overvoltage category:	II.
Pollution degree:	2
Operating position:	any
Installation:	switchboard on DIN rail EN 60715
Design:	6-MODULE

### Dimensions and weight

Dimensions:	90 x 105 x 65 mm
Weight:	307 g

### Connection

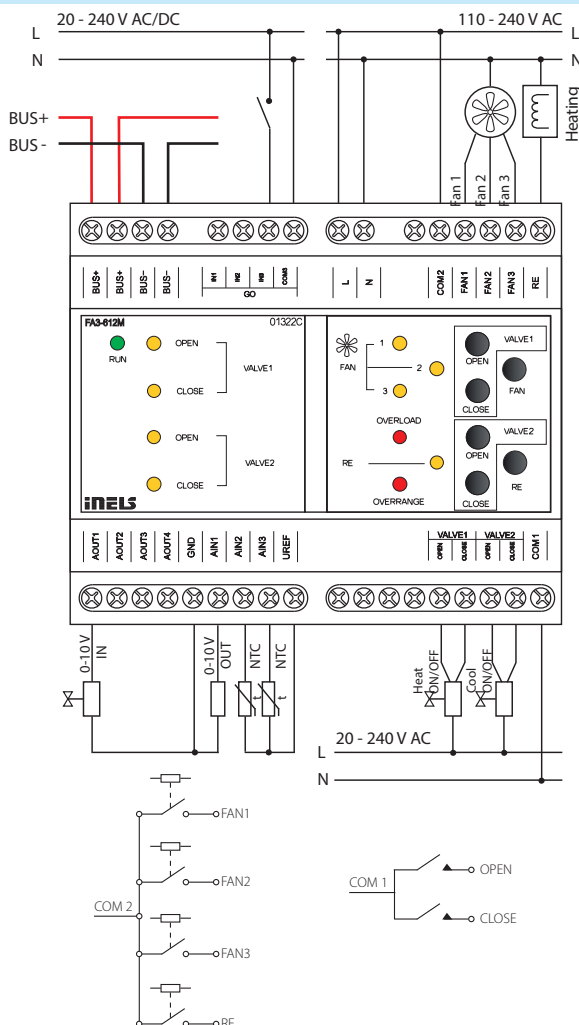

\* selectable for each input individually by configuration in the user program iDM3.  
\*\* The FA3-612M / Pt version is available for these sensors.

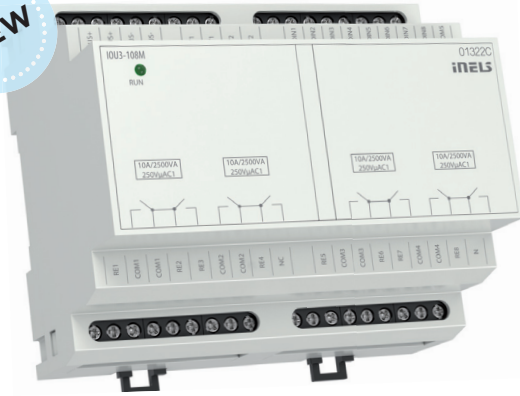

EAN code  
IOU3-108M: 8595188181884

Technical parameters	IOU3-108M
<b>Outputs</b>	
Output:	8x switching 8 A/AC1
Switched voltage:	250 V AC1, 150 W/DC
Switched output:	2500 VA/AC1, 150 W/DC
Peak current:	10 A
Output relays separated from all internal circuits:	reinforced insulation (Cat. II surges by EN 60664-1)
Isolation between relay outputs COM1, COM2 and COM3:	basic insulation (Cat. II surges by EN 60664-1)
Isolates. voltage open relay contact:	1 kV
Max. current of one common terminal:	16 A
Minimal switched current:	100 mA/10 V DC
Switching frequency without load:	300 min <sup>-1</sup>
Switching frequency with rated load:	15 min <sup>-1</sup>
Mechanical life:	10 000 000
Electrical life AC1:	100 000
Mains voltage detection:	yes - (relay switched to neutral)
<b>Inputs</b>	
Input:	8x NO or NC against GND (-)
Max. frequency pulse reading:	20 Hz
Temperature input for temperature measuring:	2x input for external thermo sensor TC, TZ (NTC 12k)
Temperature measurement range:	by type of sensor, prob from -40 °C až 125 °C
Converter resolution:	15 bit
<b>Communication</b>	
Installation BUS:	BUS
Status indication unit:	green LED RUN
<b>Power supply</b>	
Voltage of BUS/tolerance/nominal current:	27 V DC, -20/+10 %, 110 mA
Dissipated power:	3 W
<b>Connection</b>	
Terminal:	max. 2.5 mm <sup>2</sup> /1.5 mm <sup>2</sup> with sleeve
<b>Operating conditions</b>	
Operating temperature:	-20 to +55 °C
Storing temperature:	-30 to +70 °C
Protection degree:	IP20 device, IP40 mounting in the switchboard
Overvoltage category:	II.
Pollution degree:	2
Operating position:	any
Installation:	switchboard on DIN rail EN 60715
Design:	6-MODULE
<b>Dimensions and weight</b>	
Dimensions:	90 x 105 x 65 mm
Weight:	310 g

- IOU3-108M is combined actuator equipped with 8 binary inputs, 2 temperature inputs and 8 independent relays with switching potential-free contacts
- Binary inputs IOU3-108M are used to connect up to 8 devices with a potential-free contact (such as switches, buttons, burglar alarm and fire detectors or others).
- The unit can be used to read pulses from energy meters with a pulse output.
- The temperature inputs support the connection of the following temperature sensors: TC / TZ - 2-wire connection
- They are used in cases where it is necessary to measure the temperature, eg floor/space, indoor/outdoor temperature, technological equipment - boiler rooms, solar heating, etc.
- The maximum load capacity of the contacts is 10 A / 2500 VA / AC1.
- Each of the output is individually controllable and addressable.
- The relays are divided into four pairs, where each pair switches its common potential.
- The actuator is designed for switching up to eight different appliances and loads via a relay output (potential-free contact).
- IOU3-108M in 6-MODULE design is designed for mounting in a switchboard on DIN rail EN60715.

Connection

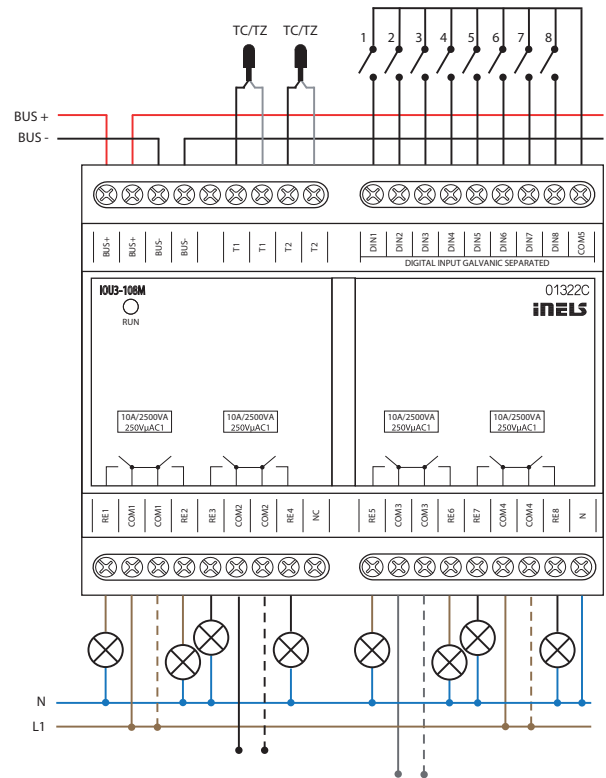

Diagram

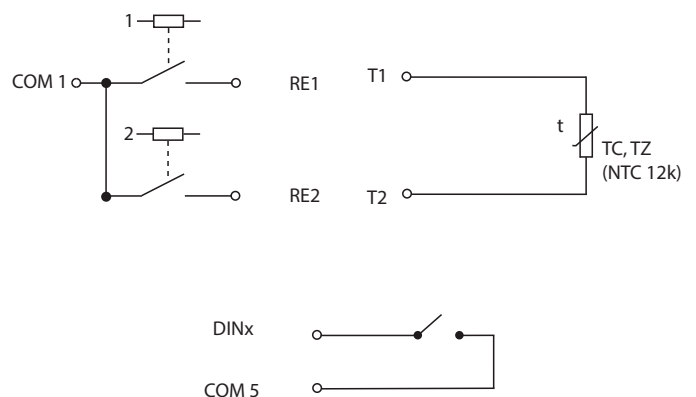



Wall units and controllers

wall

units &

controllers

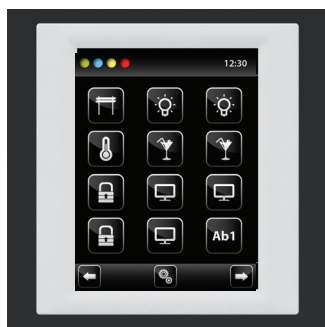

EAN code  
EST3\_white/white 8595188177009

Technical parameters		EST3
<b>Display</b>		
Type:	colored TFT LCD	
Aspect ratio:	3:4	
Visible area:	52.5 x 70 mm	
Backlight:	active	
Touchpad:	4-wire resistive	
Display:	3.5"	
Number of points:	240 x 320	
Color Depth:	16.7M (24 bit color)	
<b>Power supply</b>		
Supply voltage/tolerance:	27 V DC, -20/+10 %	
Dissipated power:	max. 2 W	
Rated current:	150 mA (at 27 V DC)	
<b>Connection</b>		
Connection:	terminals	
Connecting conductors profile:	max. 2.5 mm <sup>2</sup> /1.5 mm <sup>2</sup> with sleeve	
<b>Operating conditions</b>		
Operating temperature:	0 to +55 °C	
Storing temperature:	- 20 to +70 °C	
Protection degree:	IP20	
Overvoltage category:	II.	
Pollution degree:	2	
Operating position:	any	
Installation:	installation box	
<b>Dimensions and weight</b>		
Dimensions:	94 x 94 x 36 mm	
Weight:	120 g	

\* Ordering codes of all colours are available in the iNELS price list.

\*\* Weight is listed with plastic frame.

- The control unit with touch screen EST3 is a suitable control element of the iNELS system in places where it is necessary to control multiple devices. The unit replaces several drivers and enables minimizing the number of switches on the wall.
- EST3 features a 3.5 "color touchscreen with an aspect ratio of 3:4. The basic display resolution is 240x320 pixels. The color depth of 16.7 million colors (24 bit color, True Color).
- Use the touch sensing surface to control configured buttons and symbols on the screen just by a light touch of a finger. Individual symbols on the screen are in the "Press" animated by the associated output in the system.
- EST3 has these screens (the displayed screens can be set in iDM3):
  - buttons screen
  - temperature control screen
  - control RGB/RGBY/RGBW light sources screen
- Selecting the default screen is possible from the iDM3 software.
- For screen of buttons one of four different matrixes buttons can be used - 2x2, 2x3, 3x3 and 3x4. Matrix selection can be done from the iDM3 software. On the screen can then be used up to 12 buttons to control appliances or scenes.
- In the menu settings, directly on the EST3 component one of 48 prepared symbols (for control of lighting, shading, scenes and other technologies) can be assigned to each button or the buttons can be used to enter text (number of characters depends on the matrix of buttons and therefore the size of the buttons).
- The temperature regulation screen enables coordination of the temperature of the selected heating circuit in a range of  $\pm 3$ ,  $\pm 4$  or  $\pm 5$  °C (in relation to settings in iDM3).
- The virtual wheel can be used for temperature correction, where you can drag your finger across the screen to control the temperature by half a degree Celsius.
- The temperature correction can also be used instead of the virtual wheel symbols "+" and "-".
- EST3 units do not have an integrated temperature sensor, or terminals for connection to an external temperature sensor. Within the iDM3 software, it is possible to assign any unit of heat input system iNELS.
- The control RGB/RGBY/RGBW light sources screen allows you to comfortably control your RGB/RGBY/RGBW light sources and adjust the luminous atmosphere as needed.
- For these RGB/RGBY/RGBW light sources, it is possible to use the controls on the screen to adjust the color and brightness. It is also possible to directly set the RGB/RGBY/RGBW illumination light source into white color.
- Located in the left upper corner of the screen are 4 indicators that can signal the status of any logical input/output in the iNELS system.
- In iDM3 it is possible to define the displayed screen, the default screen, matrix of buttons, type RGB/RGBY/RGBW and a correction range for the temperature control.
- In the settings menu directly on the device EST3 it is possible to select the menu language, screen saver, sleep mode, brightness adjustment and symbols and texts for each button.
- EST3 are designed as LOGUS<sup>90</sup> devices (EST3 however cannot be placed into multi-frames with other devices in this design) and are intended for mounting to installation box.

### Connection

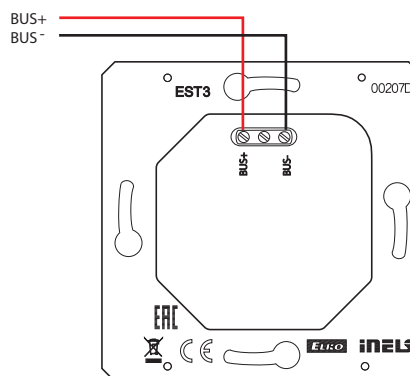



Screenshots



RGB lamp and light source control screen

- The RGB light sources control screen contains controls for managing the desired color and brightness of the RGB light sources.
- RGB control screen function is set up so that the colors R, G, B are bound together and simulate the signal level on analog inputs R, G, B and the resulting brightness of the lamp is linked to a simulated analog input 0 to 100%.
- The RGB control display is comprised of several elements and buttons.
  - a long press (touch) on the ON/OFF controls the central setting of RGB components and lamp brightness - on/off.
  - buttons in the upper half of the screen are for setting the lamp brightness from 0-100% in 5% increments (see adjustable brightness indicator in %).
  - buttons in the lower half of the screen are for setting the color comfort and accelerated lamp RGB control. The buttons have a lock function. When pressing "white illumination" button, the analog inputs are automatically set to the maximum value of individual color components, which appears as a resulting white light at the RGB light source output when these components are mixed. Then simply adjust the brightness intensity at the output. When pressing (touching) the button "RGB-based color illumination", the "white illumination", button automatically unlocks, and the "RGB-based color illumination" settings button locks. Now the values of analog inputs of individual RGB color components are preset according to the set cursor in the color wheel of the RGB scale on the EST3.

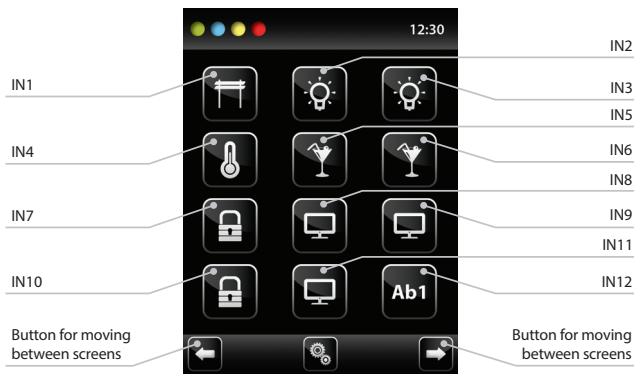

Heating control screen

- On the temperature control screen, the temperature of the selected heating circuit can be corrected in the range of  $\pm 3, \pm 4$  or  $\pm 5$  °C.
- The virtual wheel can be used for temperature correction, where you can drag your finger across the screen to control the temperature by half a degree Celsius.
- The temperature correction can also be used instead of the virtual wheel symbols "+" and "-" .

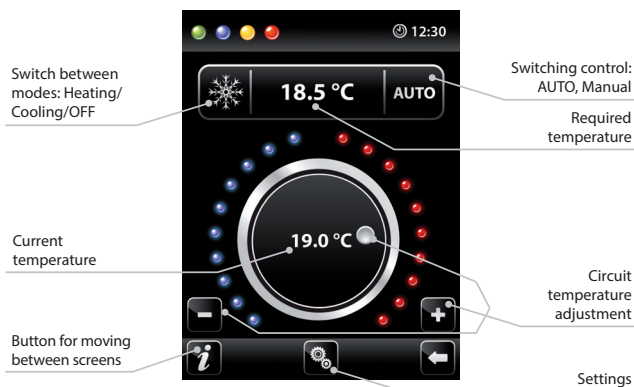

Buttons screen

- Programming iNELS system functions on each button on the screen units EST3 is the same as programming other digital inputs or events for input or button units.
- Buttons can be configured as well as other inputs in the system, both for short and also long press (> 1.5 s).
- Buttons (icons) on the screen can be used instead of control outputs for visualization of one of the digital outputs of the system iNELS. This is made possible by assigning button to the desired output.
- In doing so, the button (icons) on the screen EST3 will become signal lamps (illuminated button), showing the state of the associated output.

Additional information

- Info gives information on the device and firmware version.
- Clicking the icon brings you to the settings menu, used to edit the EST3.
- The icon returns to the buttons panel.
- The system time is displayed in the upper right corner of the screen.
- All inputs and outputs on the EST3 unit can be freely programmed and parameterized using the iDM3 program.

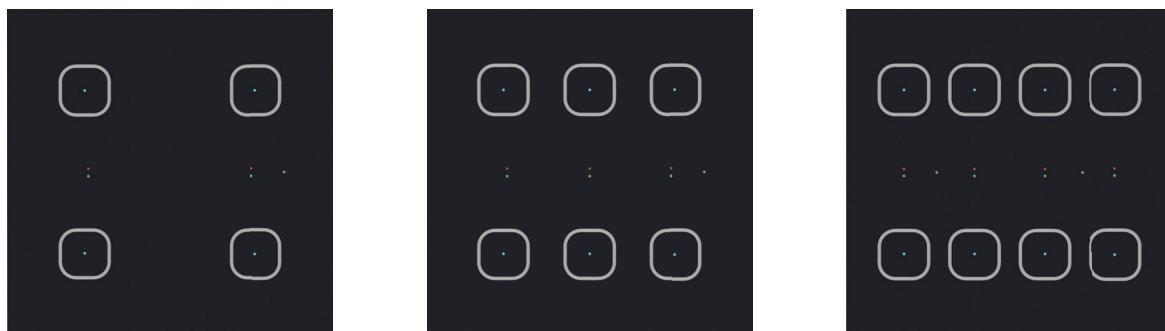

EAN code

GSB3-40/B: 8595188132909

GSB3-60/B: 8595188132916

GSB3-80/B: 8595188132923

Technical parameters	GSB3-40	GSB3-60	GSB3-80
<b>Inputs</b>			
Temperature measuring:	YES, built-in thermo sensor		
Scope and accuracy of temp. measuring:	0 to +55 °C; 0.3 °C from the range		
Number of control buttons:	4	6	8
Inputs:	2x AIN/DIN		
Resolution:	according to the settings, 10 bits		
Ext. temperature sensor:	yes, the connection between AIN1/DIN1 and AIN2/DIN2		
Type of ext. sensor:	TC/TZ		
Temperature measurement range:	-20 °C to +120 °C		
Temperature measurement accuracy:	0.5 °C from range		
<b>Outputs</b>			
Indications:	pair of LEDs (red, green)		
Number of LED:	2	3	4
<b>Communication</b>			
Installation BUS:	BUS		
<b>Power supply</b>			
Supply voltage/tolerance:	27 V DC, -20/+10 %		
Dissipated power:	max. 0.5 W		
Rated current:	25 - 40 mA (at 27 V DC), from BUS		
<b>Connection</b>			
Terminals:	0.5 - 1 mm <sup>2</sup>		
<b>Operating conditions</b>			
Relative humidity:	max. 80 %		
Operating temperature:	-20 to +55 °C		
Storing temperature:	-30 to +70 °C		
Protection degree:	IP20		
Overvoltage category:	II.		
Pollution degree:	2		
Operation position:	any		
Installation:	into installation box		
<b>Dimensions and weight</b>			
Dimensions:	94 x 94 x 36 mm		
Weight:	155 g		

- The wall controller with touch control series GSB3 is a design element (controller) in the system iNELS3 with elegant design and comfortable controlling. Controllers are available in black (e.g. GSB3-40/B) and white (e.g. GSB3-40/W) variants.
- Between each pair of touch buttons there is available a pair of indicator LEDs (green, red) to signal not only the status of the controlled appliances, but also the status of any sensor or actuator in the system.
- At the location of each touch button there is available a blue diode signaling the touching of the given button. Touching may be signaled by a vibration impulse or sound tone - selectable in the software iDM3.
- Controllers are 4-channels (GSB3-40), 6-channels (GSB3-60) and 8-channels (GSB3-80).
- All versions are in the same dimension as a basic modular wall-switch (94x94 mm).
- Each controller is equipped with a thermo sensor. It is equipped with two analog-digital inputs (AIN/DIN), and it is possible to connect two potentialless contact or an external temperature sensor TC/TZ. (for example on floor temperature measurement).
- Controllers are equipped with an ambient light intensity sensor. From the basic information from the sensor, it is possible to illuminate orientation blue diodes in the touch controls GSB3 or perform various actions in the software iDM3, e.g. illuminate light circuits in a hallway, etc.
- Advantages over conventional switches/buttons include space saving, signaling of any output system, the ability to measure temperature and also the ability to connect external buttons or detectors.
- Each channel (button) can control any actuator (appliance) in the system. It is also possible to program various functions or macro (set of functions) to each button. This allows you to control several appliances with one button simultaneously.
- Each button (channel) can have different functional modes beside lighting control:
  - a) Classic wall-switch:
    - upper button ON, bottom button OFF
  - b) Button controller (impulse relay):
    - first press ON, second press OFF.
  - c) Dimmer:
    - short press – ON/OFF
  - d) Time switch:
    - ON after press, automatically OFF after set time.
  - e) Setting light scenes – for example: for watching TV:
    - shutters down
    - main light 30% intensity
    - wall-lamps 50% intensity
- Design series LOGUS<sup>90</sup> offers glass frames in black and white color. These frames goes perfectly with GSB3 wall buttons.

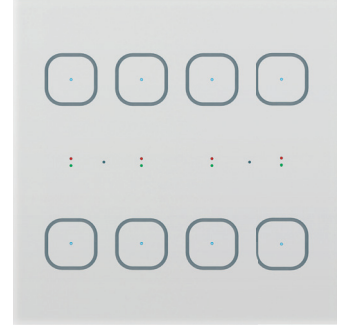
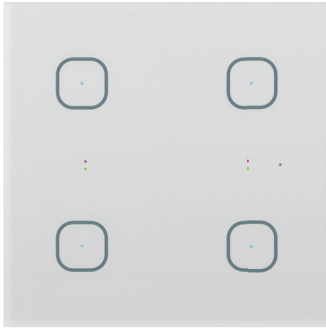

EAN code  
 GSB3-40/W: 8595188132954  
 GSB3-60/W: 8595188132985  
 GSB3-80/W: 8595188132992

Connection

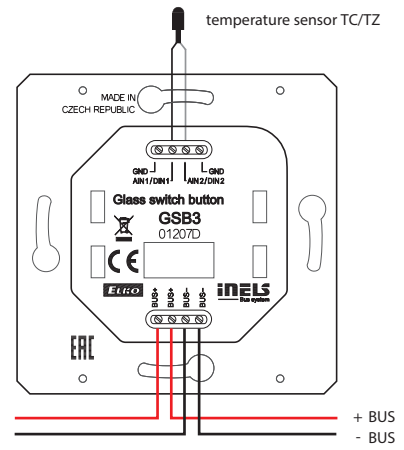
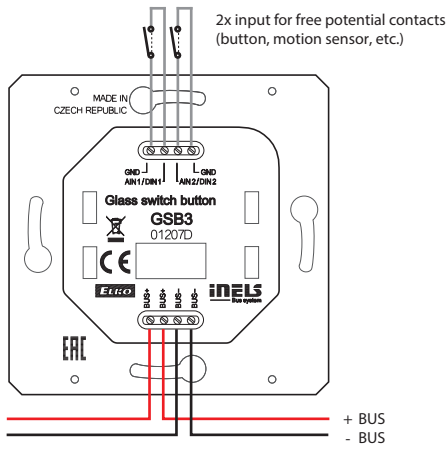

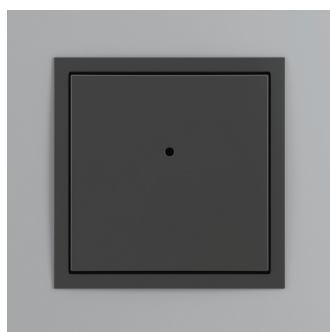

EAN code  
 WSB3-20: 8595188132343  
 WSB3-20H: 8595188132473

Technical parameters	WSB3-20	WSB3-20H
<b>Inputs</b>		
Temperature measuring:	yes, built-in temperature sensor	
Scope and accuracy of temp. measuring:	0 to +55 °C ; 0.3 °C from the range	
Number of control buttons:	2	
Humidity measurement:	NO	YES
Humidity measurement range:	-	0 to 99 % Relative humidity
Humidity measurement accuracy:	-	± 3 % Relative humidity
Inputs:	2x AIN/DIN	
External temperature sensor:	YES, the connection between AIN1/DIN1 and AIN2/DIN2	
Type of ext. sensor:	TC/TZ	
Temperature measurement range:	-20 °C to +120 °C	
Temp. measurement accuracy:	0.5 °C from range	
<b>Outputs</b>		
Indication:	two-colored LED (red, green)	
Number of LEDs:	1	
<b>Communication</b>		
Installation BUS:	BUS	
<b>Power supply</b>		
Supply voltage/tolerance:	27 V DC, -20/+10 %	
Dissipated power:	max. 0.5 W	
Rated current:	25 mA (at 27 V DC), from BUS	
<b>Connection</b>		
Terminals:	0.5 - 1 mm <sup>2</sup>	
<b>Operating conditions</b>		
Operating temperature:	-20 to +55 °C	
Storing temperature:	-30 to +70 °C	
Protection degree:	IP20	
Overvoltage category:	II.	
Pollution degree:	2	
Operation position:	any	
Installation:	into installation box	
<b>Dimensions and weight</b>		
Dimensions		
- plastic:	85.6 x 85.6 x 42 mm	
- metal, glass, wood, granite:	94 x 94 x 36 mm	
Weight:	55 g (without frame)	

- Wall controllers with low-upstroke control WSB3-20 and WSB3-20H are the main and most frequently used units (controller) in the iNELS system.
- Built-in micro-buttons with low upstroke offer elegant and easy controlling.
- Wall switches WSB3-20 and WSB3-20H are available in 2-channels version.
- Double color (red/green) LED diode indicates either status of controlled appliances or status of any sensor or actuator in the system.
- Wall buttons in WSB3 series are compatible with both types of frames LOGUS<sup>90</sup> (85.6 x 85.6 or 94 x 94 mm), therefore you can combine them with double and triple frames and classic products of the series.
- Each controller is equipped with a temperature sensor. It is also equipped with two analog/digital inputs (AIN/DIN), which can be used to connect two potentialless contacts or one external temperature sensor TC/TZ (e.g. for measuring floor temperature).
- Wall button WSB3-20H is comparable to the WSB3-20 but additionally equipped with a relative humidity meter, and for better access of air to the sensor can be used with 99621T including accessories 99622 (Vista MT) and 99,623 (Vista IRMT), instead of the housing cover 99601T.
- Compared to standard wall buttons WSB3-20 and WSB3-20H are more flexible and multifunctional. You can for example controll appliances by short and long push of the button (e.g.: dimming, shutter control, scenes).
- Each button can control any appliance in the system and can use a variety of centralized or time controlled features. Accordingly, the customer can choose the simplicity/complexity of the operation. The big advantage is the possibility to change the method of control by only making software modifications without physical interventions into the structure of the building.
- Each button (fold) can have different functional modes beside lighting control:
  - a) Classic wall-switch:
    - upper button ON, bottom button OFF
  - b) Button controller (impulse relay):
    - first press ON, second press OFF
  - c) Dimmer:
    - short press – ON/OFF
  - d) Time switch:
    - ON after press, automatically OFF after set time
  - e) Setting light scenes – for example: for watching TV:
    - shutters down
    - main light 30% intensity
    - wall-lamps 50% intensity
- WSB3 in LOGUS<sup>90</sup> design is designed for mounting into an installation box.

## Connection

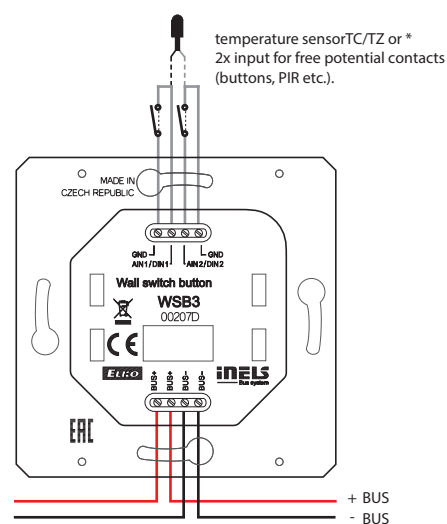

\* The choice is made in iDM3 for each unit separately.

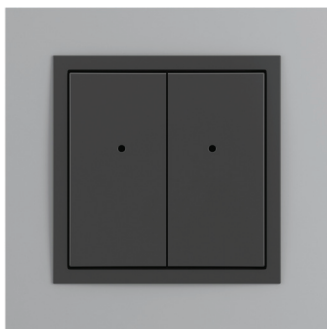

EAN code  
 WSB3-40: 8595188132336  
 WSB3-40H: 8595188133043

Technical parameters	WSB3-40	WSB3-40H
<b>Inputs</b>		
Temperature measuring:	YES, built-in temperature sensor	
Scope and accuracy of temp. measuring:	0 to +55 °C; 0.3 °C from the range	
Number of control buttons:	4	
Humidity measurement:	NO	YES
Humidity measurement range:	-	0 to 99 % Relative humidity
Humidity measurement accuracy:	-	± 3 % Relative humidity
Inputs:	2x AIN/DIN	
External temperature sensor:	YES, the connection between AIN1/DIN1 and AIN2/DIN2	
Type of external sensor:	TC/TZ	
Temp. measurement range:	-20 °C to +120 °C	
Temp. measurement accuracy:	0.5 °C from range	
<b>Outputs</b>		
Indication:	two-colored LED (red, green)	
Number of LEDs:	2	
<b>Communication</b>		
Installation BUS:	BUS	
<b>Power supply</b>		
Supply voltage/tolerance:	27 V DC, -20/+10 %	
Dissipated power:	max. 0.5 W	
Rated current:	25 mA (at 27 V DC), from BUS	
<b>Connection</b>		
Terminals:	0.5 - 1 mm <sup>2</sup>	
<b>Operating conditions</b>		
Operating temperature:	-20 to +55 °C	
Storing temperature:	-30 to +70 °C	
Protection degree:	IP20	
Overvoltage category:	II.	
Pollution degree:	2	
Operation position:	any	
Installation:	into installation box	
<b>Dimensions and weight</b>		
Dimensions		
- plastic:	85.6 x 85.6 x 42 mm	
- metal, glass, wood, granite:	94 x 94 x 36 mm	
Weight:	55 g (without frame)	

\* The choice is made in iDM3 for each unit separately.

- Wall mounted controllers with upstroke control WSB3-40 and WSB3-40H are the basic and most popular feature (control) of the iNELS system.
- Built-in micro-switch with low upstroke offers elegant and pleasant control.
- Controllers WSB3-40 and WSB3-40H are supplied with 4-channels.
- Two-coloured indication LEDs located in each controller, can signal the status of controlled appliances or the status of any sensor or actuator in the system.
- Wall buttons in WSB3 series are compatible with both types of frames LOGUS<sup>90</sup> (85.6x85.6 or 94x94 mm), therefore you can combine them with double and triple frames and classic products of the series.
- Each controller is equipped with a temperature sensor. It is also equipped with two analog/digital inputs (AIN/DIN), which can be used to connect two potentialless contacts or one external temperature sensor TC/TZ (e.g. for measuring floor temperature).
- Compared to standard wall buttons WSB3-20 and WSB3-20H are more flexible and multifunctional. You can for example controll appliances by short and long push of the button (e.g.: dimming, shutter control, scenes).
- Each button can control any appliance in the system and can use a variety of centralized or time controlled features. Accordingly, the customer can choose the simplicity/complexity of the operation. The big advantage is the possibility to change the method of control by only making software modifications without physical interventions into the structure of the building.
- Each button (fold) can have different functional modes beside lighting control:
  - a) Classic wall-switch:
    - upper button ON, bottom button OFF
  - b) Button controller (impulse relay):
    - first press ON, second press OFF
  - c) Dimmer:
    - short press – ON/OFF
  - d) Time switch:
    - ON after press, automatically OFF after set time
  - e) Setting light scenes – for example: for watching TV:
    - shutters down
    - main light 30% intensity
    - wall-lamps 50% intensity
- WSB3 in LOGUS<sup>90</sup> design is designed for mounting into an installation box.

Connection

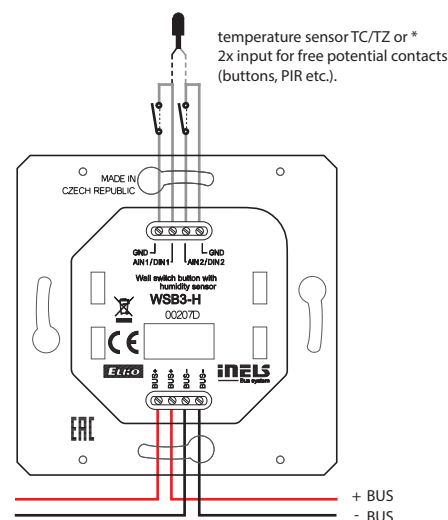

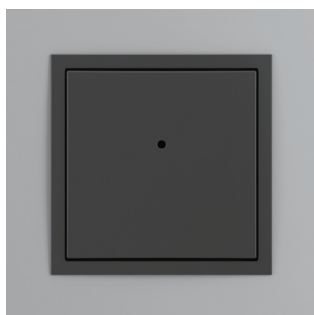

EAN code  
WMR3-21: 8595188132756

## Technical parameters WMR3-21

### Inputs

Number of control buttons:	2
----------------------------	---

### RFID readers

Supported frequencies:	13.56 MHz
Card Type:	MIFARE Ultralight, DESFire 2K (EV1), DESFire 4K (EV1)

### Outputs

Output:	1x changeover 8 A/AgSnO <sub>2</sub>
Indication:	two-color LED (red, green)
Acoustic output:	piezo-changer
Switching voltage:	230 V A/30 V DC
Switching output:	2000 VA/AC1; 240 W/DC
Peak current:	20 A/<3s
Insulation voltage between relay outputs and internal circuits:	3.75 kV, SELV according to EN 60950
Minimal switched current:	10 mA/10 V
Switching frequency without load:	300 min <sup>-1</sup>
Switching frequency with rated load:	15 min <sup>-1</sup>
Mechanical life:	1x 10 <sup>7</sup>
Electrical life AC1:	1x 10 <sup>5</sup>

### Communication

Installation BUS:	BUS
-------------------	-----

### Power supply

Supply voltage/tolerance:	27 V DC, -20/+10 %
Dissipated power:	max. 0.5 W
Rated current:	50 mA (at 27 V DC), from BUS

### Connection

Data:	terminals, 0,5 - 1 mm <sup>2</sup>
Network:	max. 2.5 mm <sup>2</sup> /1.5 mm <sup>2</sup> with sleeve

### Operating conditions

Operating temperature:	-20 to +55 °C
Storing temperature:	-30 to +70 °C
Protection degree:	IP20
Overvoltage category:	II.
Pollution degree:	2
Operation position:	any
Installation:	into installation box

### Dimensions and weight

Dimensions	
- plastic:	85.6 x 85.6 x 42 mm
- metal, glass, wood, granite:	94 x 94 x 36 mm
Weight:	68 g (without frame)

- WMR3-21 is a wall-mounted card reader that is designed for read contactless media (smart cards, key chains, etc.), which are used for controlling access to buildings or their parts.
- With the glass controller WMR3-21 users will appreciate the easy of control using two push buttons, which can be assigned different control functions lighting, shading, scenes, heating, etc.
- WMR3-21 reader can be used to control the security system (locking/ un-locking) access system (opening doors, gates, etc.) or appliances (based on assigned rights).
- WMR3-21 supports RFID media with the carrier frequency of 13.56 MHz. Supported card types MIFARE Ultralight, DESFire 2K (EV1), DESFire 4K (EV1).
- WMR3-21 is also equipped with 8 A relay output with changeover contact AgSnO<sub>2</sub>, by which controlled devices can be switched directly (or any actuator in the system can be set in software iDM3).
- Indication two-color LED in the controller cover can indicate not only the status of controlled appliance, but also the status of any sensor or actuator in the system.
- Wall card reader WMR3-21 is compatible with both types of frames LOGUS<sup>90</sup> (85.6 x 85.6 or 94 x 94 mm), therefore you can combine them with double and triple frames and classic products of the series.

## Connection

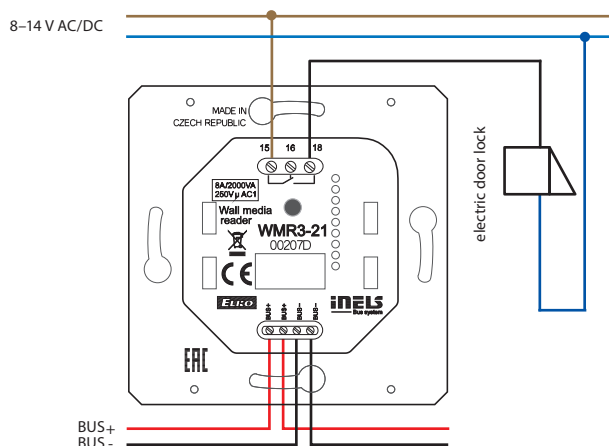



EAN code  
 GMR3-61/B: 8595188155854  
 GMR3-61/W: 8595188155793

**Technical parameters** **GMR3-61**

**Inputs**

Temperature measuring:	YES, built-in temperature sensor
Scope and accuracy of temp. measuring:	0 to +55°C; 0.3°C from the range
Number of control buttons:	6

**RFID readers**

Supported frequencies:	13.56 MHz
Card Type:	MIFARE Ultralight, DESFire 2K (EV1), DESFire 4K (EV1)

**Outputs**

Indication:	3 pairs of LED (red, green)
Output:	1x changeover 8 A/AgSnO <sub>2</sub>
Acoustic output:	piezo-changer
Switching voltage:	230 V AC/30 V DC
Switching output:	2000 VA/AC1; 240 W/DC
Peak current:	20 A/<3s
Insulation voltage between relay outputs and internal circuits:	3.75 kV, SELV according to EN 60950
Minimal switched current:	10 mA/10 V
Switching frequency without load:	300 min <sup>-1</sup>
Switching frequency with rated load:	15 min <sup>-1</sup>
Mechanical life:	1x 10 <sup>7</sup>
Electrical life AC1:	1x 10 <sup>5</sup>

**Communication**

Installation BUS:	BUS
-------------------	-----

**Power supply**

Supply voltage/tolerance:	27 V DC, -20/+10 %
Dissipated power:	max. 2 W
Rated current:	50 mA (at 27 V DC), from BUS

**Connection**

Data:	terminals, 0.5 - 1 mm <sup>2</sup>
Network:	max. 2.5 mm <sup>2</sup> /1.5 mm <sup>2</sup> with sleeve

**Operating conditions**

Relative humidity:	max. 80 %
Operating temperature:	-20 to +55 °C
Storing temperature:	-30 to +70 °C
Protection degree:	IP20
Overvoltage category:	II.
Pollution degree:	2
Operation position:	any
Installation:	into installation box

**Dimensions and weight**

Dimensions:	94 x 94 x 36 mm
Weight:	155 g

- Wall RFID card reader GMR3-61 is designed for reading of contactless media (chip cards, key fobs, tags, etc.), which are used for controlling access to buildings or parts of buildings.
- With the glass controller GMR3-61 users will appreciate the elegant design and the easy of control using six touch buttons, which can be assigned different control functions lighting, shading, scenes, heating, etc.
- GMR3-61 a design element of the (control) system iNELS and is available in black (GMR3-61/B) and white (GMR3-61/W) variants.
- GMR3-61 reader can be used to control the security system (locking/ unlocking) access system (opening doors, gates, etc.) or appliances (based on assigned rights).
- GMR3-61 supports RFID media with the carrier frequency of 13.56 MHz. Supported card types MIFARE Ultralight, DESFire 2K (EV1), DESFire 4K (EV1).
- The GMR3-61 is also equipped with 8 A relay output with changeover contact AgSnO<sub>2</sub>, which can be switched directly by reader (or by any controller in the system).
- Between each pair of touch keys is a pair of indicator LEDs (Green, Red) to indicate the status of the controlled appliance, or the state of any sensor or actuator in the system.
- Located on each touch button is a blue LED indicator, signalling the touch of a button. Touching may also be signalled by a vibrating pulse or audible tone - optionally in the software iDM3.
- All variants of GMR3-61 are available in sizes of luxury controllers LOGUS<sup>90</sup> (94 x 94 mm).
- GMR3-61 reader is equipped with a sensor of ambient light intensity. Based on information from the sensor can switch the orientation of blue LEDs on the touch-pad GSB3 or perform various actions with the software iDM3, eg. To control the lighting circuits in the corridor and others.
- GMR3-61 cannot be installed into multiple frames they are designed for mounting into installation boxes.

**Connection**

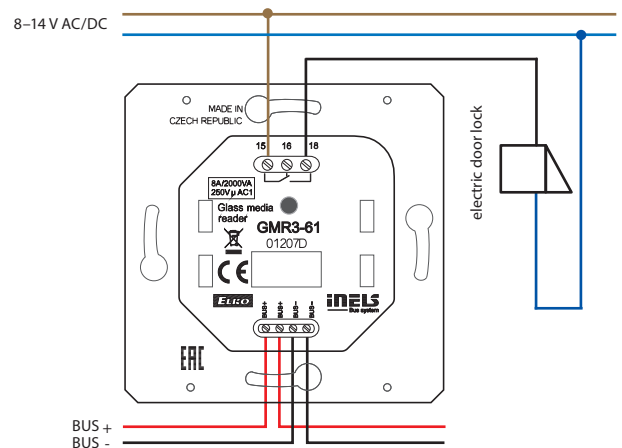



EAN code	
IDRT3-1 white:	8595188149488 (device, cover)
IDRT3-1 ivory:	8595188179614 (device, cover)
IDRT3-1 ice:	8595188179591 (device, cover)
IDRT3-1 pearl:	8595188179621 (device, cover)
IDRT3-1 aluminium:	8595188179584 (device, cover)
IDRT3-1 gray:	8595188179607 (device, cover)

### Technical parameters

### IDRT3-1

#### Inputs

Temperature measuring:	YES, built-in thermo sensor
Range/accuracy of temp. measuring:	0 to +55 °C; 0.3 °C from range
Heating/cooling circuit correction:	±3, ±4 or ±5 °C
Manual control of heating/cooling circuit:	2 x buttons
External temperature sensor:	YES, the connection between AIN1/DIN1 and AIN2/DIN2
Type of external sensor:	TC/TZ
Temperature measurement range:	-20 °C to +120 °C
Temperature measurement accuracy:	0.5 °C from range

#### Communication

Installation:	BUS
Display:	symbol display
Backlight:	YES

#### Power supply

Supply voltage/tolerance:	27 V DC, -20/+10 %
Dissipated power:	max. 0.5 W
Rated current:	20 mA (at 27 V DC), from BUS

#### Connection

Terminals:	0.5 - 1 mm <sup>2</sup>
------------	-------------------------

#### Operating conditions

Operating temperature:	0 to +50 °C
Protection degree:	IP20
Overvoltage category:	II.
Pollution degree:	2
Operation position:	vertical, downward with BUS terminal
Installation:	into installation box

#### Dimensions and weight

Dimensions	
- plastic:	85.6 x 85.6 x 50 mm
- metal, glass, wood, granite:	94 x 94 x 50 mm
Weight:	76 g (without frame)

- IDRT3-1 is a digital wall temperature controller used to regulate the temperature in a room.
- Using the IDRT3-1, it is possible to correct the given heating/cooling circuit within a range of ±3, ±4 or ±5 °C (optional in SW iDM3).
- The temperature controller is equipped with an integrated heat sensor used to measure the room temperature. It is also equipped with two analog digital inputs (AIN/DIN), which can be used to connect two potential free contacts or a single external temperature sensor TC/TZ (e.g. for measuring the floor temperature).
- The display shows the current temperature and after pressing one of two buttons under the display, you can control the desired temperature.
- Readability improves after pressing one of the buttons to activate the backlight.
- Heating/cooling circuit is assigned with a thermo-regulator using iDM3.
- In the case of temperature correction within ±3, ±4 or ±5 °C, this change is valid until the next time mark within the time schedule established in iDM3.
- IDRT3 -1 in design LOGUS<sup>90</sup> is intended for mounting into an installation box.

### Connection

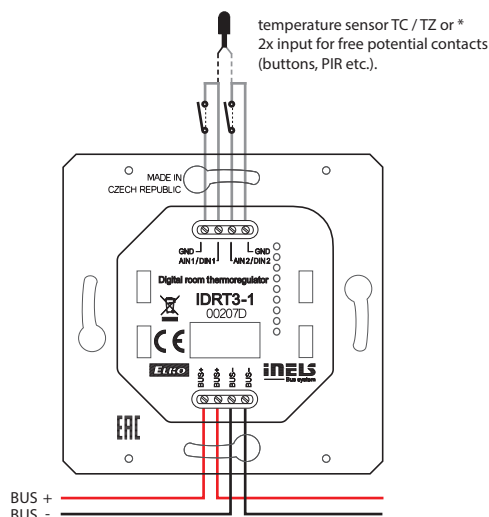

\* The choice is made in iDM3 for each unit separately.



Hotel units

hot

el

units



The picture of device is illustrative, the icons (symbols) are configurable by the customer.

EAN code  
GCR3-11/B: 8595188157476  
GCR3-11/W: 8595188157483

Technical parameters		GCR3-11
<b>Input</b>		
Illuminance sensor:	1 to 100 000 Lx	
<b>Buttons</b>		
Number of control buttons:	3	
Type:	capacitive	
Indication:	coloured illuminated symbol	
<b>RFID readers</b>		
Supported frequencies:	13.56 MHz	
Card Type:	MIFARE Ultralight, DESFire 2K (EV1), DESFire 4K (EV1)	
<b>Outputs</b>		
Signalling:	Do Not Disturb, Make Up Room	
Output:	1x changeover 8 A/AgSnO <sub>2</sub>	
Acoustic output:	piezo-changer	
Tactile output:	vibration motor	
Switching voltage:	230 V AC/30 V DC	
Switching output:	2000 VA/AC1; 240 W/DC	
Peak current:	20 A/<3s	
Insulation voltage between relay outputs and internal circuits:	3.75 kV, SELV according to EN 60950	
Minimal switched current:	10 mA/10 V	
Switching frequency without load:	300 min <sup>-1</sup>	
Switching frequency with rated load:	10 min <sup>-1</sup>	
Mechanical life:	1x 10 <sup>7</sup>	
Electrical life AC1:	1x 10 <sup>5</sup>	
<b>Communication</b>		
Installation BUS:	BUS	
<b>Power supply</b>		
Supply voltage/tolerance:	27 V DC, -20/+10 %	
Dissipated power:	max. 0.5 W	
Rated current:	100-130 mA (at 27 V DC), from BUS	
<b>Connection</b>		
Data:	terminals, 0,5 - 1 mm <sup>2</sup>	
Network:	max. 2.5 mm <sup>2</sup> /1.5 mm <sup>2</sup> with sleeve	
<b>Operating conditions</b>		
Relative humidity:	max. 80 %	
Operating temperature:	-20 to +55 °C	
Storing temperature:	-30 to +70 °C	
Protection degree:	IP20	
Overvoltage category:	II.	
Pollution degree:	2	
Operation position:	any	
Installation:	into installation box	
<b>Dimensions and weight</b>		
Dimensions:	94 x 94 x 36 mm	
Weight:	161 g	

- Glass RFID card reader GCR3-11 is part of a comprehensive range of glass iNELS control units and can be advantageously used in all projects, e.g. guest room management system (GRMS).
- GCR3-11 card reader is designed for reading smart cards, which are intended to enter the hotel room or any other part of the building.
- GCR3-11 supports RFID media with a carrier frequency of 13.56 MHz. Supported card types MIFARE Ultralight, DESFire 2K (EV1), DESFire 4K (EV1).
- The GCR3-11 is a design component of the iNELS system and is available in elegant black (GCR3-11/B) and white (GCR3-11/W) variants.
- Input card reader is the first device of guest room management system (GRMS), with which the hotel guest comes into contact first and therefore was designed with an emphasis on representative design.
- Engraving of symbols is possible upon a request. The room number as well as the logo of the hotel can be also engraved on each component.
- The controller is also equipped with touch button with function of bell and with two icons to indicate the status of guest requests, e.g. "Do Not Disturb" and "Make Up Room", whose state guest can set from multi-function touch panel EHT3, glass card holder GCH3-31, glass switch buttons GSB3-20/S, GSB3-40/S, GSB3-60/S or such GSP3-100 glass switch panel.
- Individual symbols can be illuminated in one of seven colours - red, green, blue, yellow, pink, turquoise and white.
- Reader GCR3-11 is equipped with an 8 A relay output with AgSnO<sub>2</sub> contact for door lock control.
- Reader GCR3-11 is equipped with a sensor for ambient light intensity. Based on information from the sensor it can e.g. switch the lighting circuits in the corridor.
- All versions are in the size of the module (94x94 mm) from the line of luxury switches and sockets LOGUS<sup>90</sup> and are therefore fully in line with the design of frames for the sockets of this series, where you can just as for the controllers choose white and black glass frames.
- GCR3-11 are designed for mounting into an installation box.

### Connection

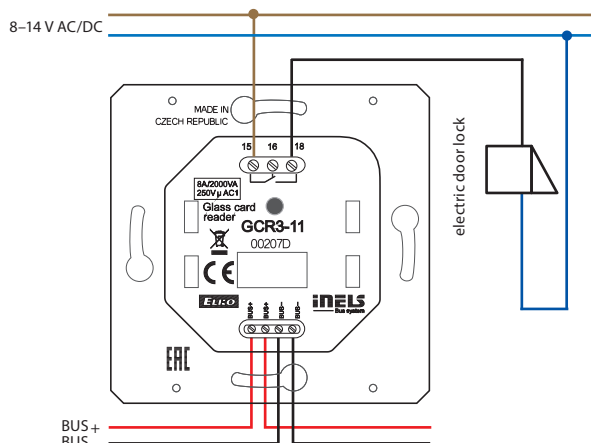

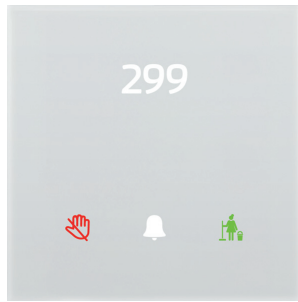
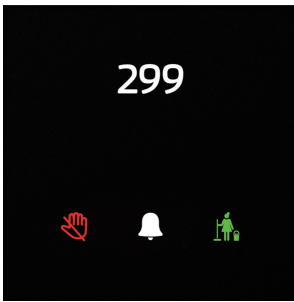

The picture of device is illustrative, the icons (symbols) are configurable by the customer.

EAN code  
 GDB3-10/B: 8595188157261  
 GDB3-10/W: 8595188115728

**Technical parameters** **GDB3-10**

Inputs	
Temperature measuring:	YES, built-in temperature sensor
Scope and accuracy of temp. measuring:	0 to +55 °C; 0.3 °C from the range
Inputs:	2x AIN/DIN
Resolution:	by setting 10-bit
External temperature sensor:	YES, the connection between AIN1/DIN1 and AIN2/DIN2
Type of external sensor:	TC/TZ
Temperature measurement range:	-20 °C to +120 °C
Temperature measurement accuracy:	0.5 °C from the range
Illuminance sensor:	1 to 100 000 Lx

Buttons	
Number of control buttons:	1
Type:	capacitive
Indication:	coloured illuminated symbol

Output	
Signalling:	Do Not Disturb, Make Up Room
Acoustic output:	piezo-changer
Tactile output:	vibration motor

Communication	
Installation BUS:	BUS

Power supply	
Supply voltage/tolerance:	27 V DC, -20/+10 %
Dissipated power:	max. 0.5 W
Rated current:	50 mA (at 27 V DC), from BUS

Connection	
Terminals:	0.5 - 1 mm <sup>2</sup>

Operating conditions	
Relative humidity:	max. 80 %
Operating temperature:	-20 to +55 °C
Storing temperature:	-30 to +70 °C
Protection degree:	IP20
Overvoltage category:	II.
Pollution degree:	2
Operation position:	on the wall, observing the conditions for correct installation of the thermostat
Installation:	into installation box

Dimensions and weight	
Dimensions:	94 x 94 x 36 mm
Weight:	154 g

- Glass info panel GDB3-10 is part of a comprehensive series of glass iNELS control units for guest room management system (GRMS), and is used to indicate the status of guest requests "Do Not Disturb" and "Make Up Room".
- Thanks to the capacitive touch button, the info panel can also be used for the function of the bell.
- Glass info panel is a design component of the iNELS system and is available in elegant black (GDB3-10/B) and white (GDB3-10/W) version.
- Engraving of symbols is possible to customize the device according to the client's requirements. The room number as well as the logo of the hotel can be also engraved on each component.
- The "Do Not Disturb" or "Make Up Room" statuses can be entered by the hotel guest from a multi-functional touch panel EHT3, glass card holder GCH3-31, glass switch buttons GSB3-20/S, GSB3-40/S, GSB3-60/S or such GSP3-100 glass switch panel.
- All versions are in the size of the module (94 x 94 mm) from the line of luxury switches and sockets LOGUS<sup>90</sup> and are therefore fully in line with the design of frames for the sockets of this series, where you can just as for the controllers choose white and black glass frames.
- Info panel GDB3-10 is equipped with a sensor for ambient light intensity. Based on information from the sensor it can e.g. switch the lighting circuits in the corridor.
- Individual symbols can be illuminated in one of seven colours - red, green, blue, yellow, pink, turquoise and white.
- GDB3-10 are designed for mounting into an installation box.

**Connection**

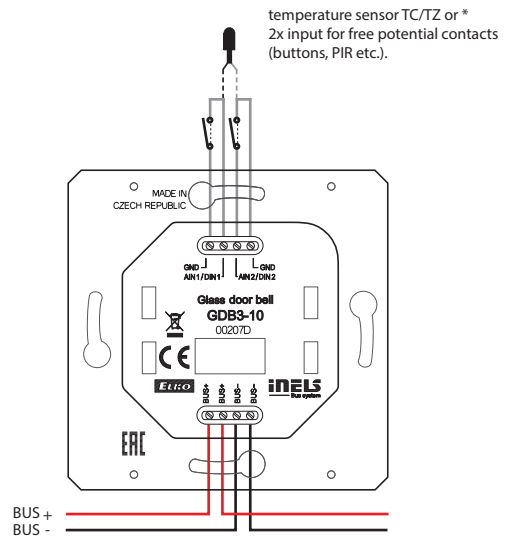

\* The choice is made in iDM3 for each unit separately.



GCH3-31/B

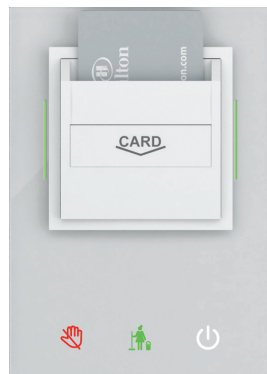

GCH3-31/W

EAN code  
GCH3-31/B\_white 8595188134996  
GCH3-31/W\_white 8595188134941

The picture of device is illustrative, the icons (symbols) are configurable by the customer.

Technical parameters	GCH3-31
<b>Input</b>	
Illuminance sensor:	1 to 100 000 Lx
<b>Buttons</b>	
Number of control buttons:	3
Typ:	capacitive
Indication:	coloured illuminated symbol
<b>RFID readers</b>	
Supported frequencies:	13.56 MHz
Card Type:	MIFARE Ultralight, DESFire 2K (EV1), DESFire 4K (EV1)
<b>Outputs</b>	
Signalling:	Do Not Disturb, Make Up Room
Output:	1x changeover 8 A/AgSnO <sub>2</sub>
Acoustic output:	piezo-changer
Tactile output:	vibration motor
Switching voltage:	230 V AC/30 V DC
Switching output:	2000 VA/AC1; 240 W/DC
Peak current:	20 A/<3s
Insulation voltage between relay outputs and internal circuits:	3.75 kV, SELV according to EN 60950
Minimal switched current:	10 mA/10 V
Switching frequency without load:	300 min <sup>-1</sup>
Switching frequency with rated load:	10 min <sup>-1</sup>
Mechanical life:	1x 10 <sup>7</sup>
Electrical life AC1:	1x 10 <sup>5</sup>
<b>Communication</b>	
Installation BUS:	BUS
<b>Power supply</b>	
Supply voltage/tolerance:	27 V DC, -20/+10 %
Dissipated power:	max. 2 W
Rated current:	100-120 mA (at 27 V DC), from BUS
<b>Connection</b>	
Data:	terminals, 0,5 - 1 mm <sup>2</sup>
Network:	max. 2.5 mm <sup>2</sup> /1.5 mm <sup>2</sup> with sleeve
<b>Operating conditions</b>	
Relative humidity:	max. 80 %
Operating temperature:	-20 to +55 °C
Storing temperature:	-30 to +70 °C
Protection degree:	IP20
Overvoltage category:	II.
Pollution degree:	2
Operation position:	any
Installation:	into installation box
<b>Dimensions and weight</b>	
Dimensions:	142 x 94 x 36 mm
Weight:	210 g

- Glass card holder GCH3-31 is part of a comprehensive range of glass iNELS control units for guest room management system (GRMS).
- GCH3-31 serves for inserting the RFID card into the holder, whereby the system acquires the information about whether the hotel guest is present in the room. With this information it is possible to ensure for example Exit function with relation to energy savings in the absence of a guest in the room.
- Glass card holder is a design component of the iNELS system and is available in elegant black (GCH3-31/B) and white (GCH3-31/W) version.
- The GCH3-31 component is equipped with an RFID reader and is thus able to identify the specific hotel card inserted. Power saving function in the absence of a guest cannot be bypassed by simply inserting business cards into the holder.
- GCH3-31 supports RFID media with a carrier frequency of 13.56 MHz. Supported card types are MIFARE Ultralight, DESFire 2K (EV1), DESFire 4K (EV1).
- The unit is also equipped with three touch buttons that can be used for example to set room status "Do Not Disturb" or "Make Up Room". This condition is then signalled to the glass card reader GCR3-11 or glass info panel GDB3-10 which are placed before the entrance to the room. Information may be sent directly to the hotel reception.
- Engraving of symbols is possible upon a request. The logo of the hotel can be shown as well. Likewise, it is also possible to adapt the card design.
- The GCH3-31 unit is equipped with an 8 A relay output and an AgSnO<sub>2</sub> contact.
- Individual symbols can be illuminated in one of seven colours - red, green, blue, yellow, pink, turquoise and white.
- GCH3-31 are designed for mounting into an installation box.

### Connection

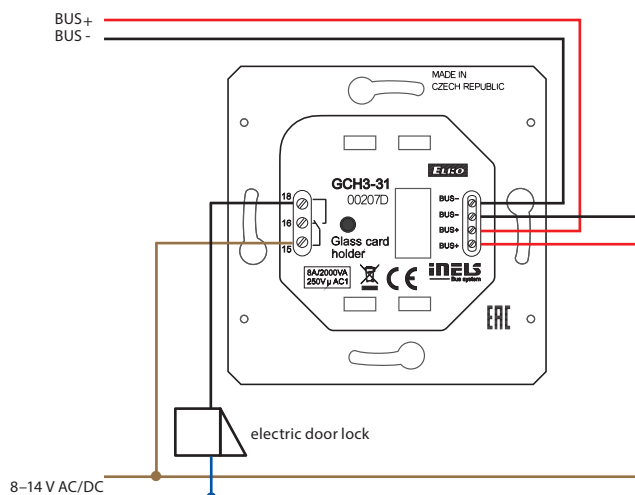



EAN code  
 EHT3 (white frame, white intermediate frame, white back cover): 8595188156196

Technical parameters		EH3
<b>Display</b>		
Type:	colored TFT LCD	
Aspect ratio:	3:4	
Visible area:	52.5 x 70 mm	
Backlight:	active	
Touchpad:	4-wire resistive	
Display:	3.5"	
Number of points:	240 x 320	
Color Depth:	16.7 M (24 bit color)	
<b>Power supply</b>		
Supply voltage/tolerance:	27 V DC, -20/+10 %	
Rated current:	150 mA (at 27 V DC)	
<b>Connection</b>		
Connection:	terminals	
Connecting conductors profile:	max. 2.5/1.5 mm <sup>2</sup> with sleeve	
<b>Operating conditions</b>		
Operating temperature:	0 to +55 °C	
Storing temperature:	- 20 to +70 °C	
Protection degree:	IP20	
Overvoltage category:	II.	
Pollution degree:	2	
Operating position:	any	
Installation:	installation box	
<b>Dimensions and weight</b>		
Dimensions:	94 x 94 x 36 mm	
Weight**	127 g	

\* Order codes of all colours are available in the iNELS price list.  
 \*\* Weight is listed with plastic frame.

- The control unit with touch screen EHT 3 is a suitable control element for iNELS in places where it is required to control multiple devices. The unit replaces multiple controllers and allows minimisation of the number of switches on the wall.
- EHT3 control unit is also available in glass frames in black or white and is thus part of a comprehensive glass iNELS series of units for the management of the hotel rooms (GRMS).
- The EHT3 is primarily designed to control hotel rooms (Guest Room Management System), but it can also be used in other projects such as a multi-function control panel.
- EHT3 offers a user-friendly interface to control the hotel room; it was designed so that guests could easily create an environment that allows them to feel like home.
- Changing the Graphical Interface is possible in consultation with the manufacturer to adapt it to specific hotel, office building and restaurant projects.
- With the units it is possible to adjust the temperature (a version is available with the possibility to adjust the fan speed of fan coil units), light scenes, shading, music and it is also possible to transmit information "Do Not Disturb" and "Make Up Room"
- The unit enables the control of volume, choice of Internet radio stations from the LARA Radio player.
- "Do Not Disturb" and "Make Up Room" information about the state of the rooms can be visualized on a GHR3-11 glass reader or GDB3-10 glass info panel, which is located in the corridor at the entrance to the room, and it is also possible to send the information of these events directly to the front desk to inform staff.
- EHT3 features a 3.5" color touchscreen with an aspect ratio of 3:4. The basic display resolution is 240x320 pixels. The color depth is 16.7 million colors (24 bit color, True Color).
- Using the sensor touchpad, buttons and symbols can be operated on the screen by a gentle touch of a finger. The symbols on the screen are by "pressing" animate an associated outlet in the system.
- EHT3 design is drawn into a row of instruments LOGUS<sup>90</sup> (EHT3 but you cannot install into multi-frames with other devices in this design) and is designed for mounting into installation box.

**Connection**

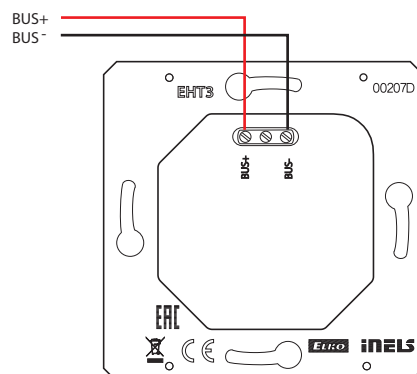

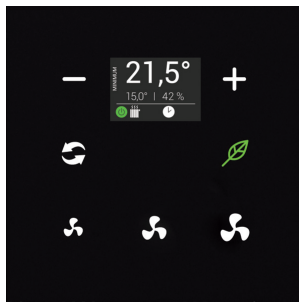

The picture of device is illustrative, the icons (symbols) are configurable by the customer.

EAN code  
GRT3-50/B: 8595188156301  
GRT3-50/W: 8595188156349

## Technical parameters GRT3-50

### Inputs

Temperature measuring:	YES, built-in temperature sensor
Scope and accuracy of temp. measurement:	0 to +55 °C; 0.3 °C from the range
Humidity measurement:	YES
Humidity measurement range:	0 to 99 % RH
Humidity measurement accuracy:	± 3 % relative humidity
Inputs:	2x AIN/DIN
Resolution:	by setting 10-bit
External temperature sensor:	YES, the connection between AIN1/DIN1 and AIN2/DIN2
Type of external sensor:	TC/TZ
Temperature measurement range:	-20 °C to +120 °C
Temperature measurement accuracy:	0.5 °C from the range

### Buttons

Number of control buttons:	5
Type:	capacitive
Indication:	coloured illuminated symbol

### Display

Display:	colored TFT, 20 x 25.5 mm
Resolution:	240 x 240 pixels

### Outputs

Acoustic output:	piezo-changer
Tactile output:	vibration motor

### Communication

Installation BUS:	BUS
-------------------	-----

### Power supply

Supply voltage/tolerance:	27 V DC, -20/+10 %
Dissipated power:	max. 0.5 W
Rated current:	85 mA (at 27 V DC), from BUS

### Connection

Terminals:	0.5 - 1 mm <sup>2</sup>
------------	-------------------------

### Operating conditions

Relative humidity:	max. 80 %
Operating temperature:	-20 to +55 °C
Storing temperature:	-30 to +70 °C
Protection degree:	IP20
Overvoltage category:	II.
Pollution degree:	2
Operation position:	any
Installation:	on the wall, observing the conditions for correct installation of the thermostat

### Dimensions and weight

Dimensions:	94 x 94 x 36 mm
Weight:	156 g

- Glass room thermo-regulator GRT3-50 is part of a comprehensive range of glass iNELS control units for guest room management system (GRMS) and serves to regulate the temperature in the room.
- GRT3-50 thermo-regulator has a display for displaying the current room temperature and desired temperature. To adjust the required temperature, it is possible to use the touch buttons with symbols "-" and "+".
- GRT3-50 is also suitable for controlling fan coils and fan speed can be easily adjusted by using the touch buttons with symbols.
- Thermo-regulator GRT3-50 also has a further two touch buttons whose function can be adjusted by software, for example fan coil on/off, heating/cooling or comfort temperature for heating or cooling.
- Thermo-regulator is equipped with an integrated temperature sensor for ambient temperature measurement.
- The glass room thermo-regulator is a design component of the iNELS system and is available in elegant black (GRT3-50/B) and white (GRT3-50/W) version.
- Engraving of symbols is possible upon a request.
- Individual symbols can be illuminated in one of seven colours - red, green, blue, yellow, pink, turquoise and white.
- GRT3-50 are designed for mounting into an installation box.

## Connection

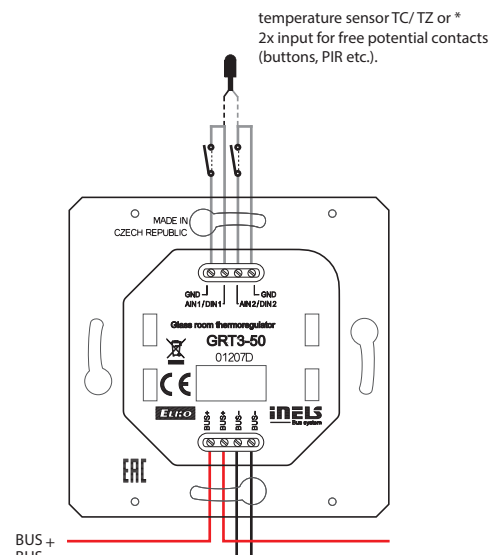

\* The choice is made in iDM3 for each unit separately.

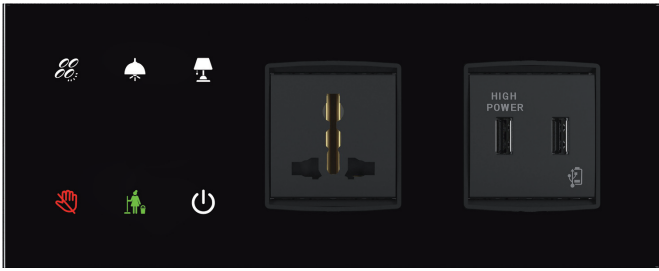

GBP3-60/BR/2F

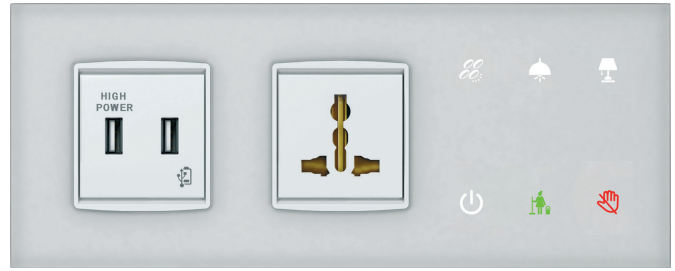

GBP3-60/WL/2F

EAN code  
 GBP3-60/BL/2F: 8595188135320  
 GBP3-60/WL/2F: 8595188135337  
 GBP3-60/BR/2F: 8595188157285  
 GBP3-60/WR/2F: 8595188157292

The picture of device is illustrative, the icons (symbols) and wiring accessories are configurable by the customer.

**Technical parameters**

**GBP3-60**

**Inputs**

Inputs:	2x AIN/DIN
Resolution:	by setting 10-bit
External temperature sensor:	YES, the connection between AIN1/DIN1 and AIN2/DIN2
Type of external sensor:	TC/TZ
Temperature measurement range:	-20 °C to +120 °C
Temperature measurement accuracy:	0.5 °C from the range
Illuminance sensor:	1 to 100 000 Lx

**Buttons**

Number of control buttons:	6
Type:	capacitive
Indication:	coloured illuminated symbol

**Outputs**

Acoustic output:	piezo-changer
Tactile output:	vibration motor

**Communication**

Installation BUS:	BUS
-------------------	-----

**Power supply**

Supply voltage/tolerance:	27 V DC, -20/+10 %
Dissipated power:	max. 0.5 W
Rated current:	25-50 mA (at 27 V DC), from BUS

**Connection**

Terminals:	0.5 - 1 mm <sup>2</sup>
------------	-------------------------

**Operating conditions**

Relative humidity:	max. 80 %
Operating temperature:	-20 to +55 °C
Storing temperature:	-30 to +70 °C
Protection degree:	IP20
Overtoltage category:	II.
Pollution degree:	2
Operation position:	any
Installation:	on the wall, observing the conditions for correct installation of the thermostat

**Dimensions and weight**

Dimensions:	GBP3-60/1F: 165 x 94 x 36 mm, GBP3-60/2F: 236 x 94 x 36 mm
Weight:	according to the selected module

\* Order codes are available in the iNELS price list.

- Glass bedside panel GBP3-60 is part of a comprehensive range of iNELS control units for guest room management system (GRMS). Bedside panel is composed from 3-MODULE, of which one is module of touch buttons and two are modules to power for example mobile devices.
- The GBP3-60 is available in several designs, making it a very flexible and effective solution for a variety of projects. The following variants are available:
  - left/right version provides the same ease of operation from both sides of the bed.
  - 2-MODULE (1F)/3-MODULE (2F) design enables you to add a touch module with one or two power supply modules, network connection or multimedia.
  - black/white elegant design suitable for almost any interior.
- GBP3-60 panel is equipped with six customizable touch buttons whose function can be software adapted to the requirements of the investor. Of course there is the possibility of using the "Master OFF", then you can select functions for switching and dimming of lighting, shading control, different scenarios etc.
- Engraving of symbols is possible upon a request.
- GBP3-60 can be equipped with a number of modules, for example.
  - power AC sockets: French, British, Multi, and Shockproof
  - other types of modules: USB, LAN, Media
- The GBP3-60 panel is equipped with an ambient light sensor.
- Individual symbols can be illuminated in one of three colours - red, green and blue.
- GBP3-60/1F is designed for mounting into a double mounting box, GBP3-60/2F to a triple mounting box (distance between the centres of each of openings is 71 mm).

**Connection**

GBP3-60/xR/2F-23x-20x

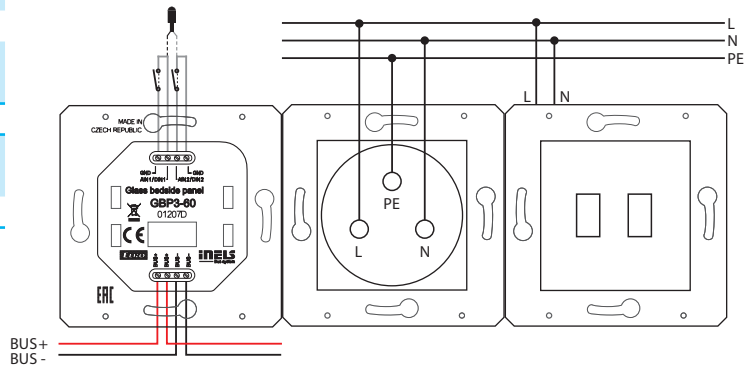

Switch

Push button



One switch /1M

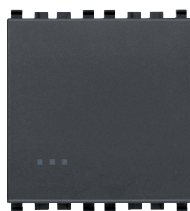

One switch /2M



Three switches



One Push button /1M



One Push button /2M

- 11B (20001)
- 11W (20001.B)

- 12B (20001.2)
- 12W (20001.2.B)

- 14B (20003)
- 14W (20003.B)

- 49B (20008)
- 49W (20008.B)

- 50B (20008.7)
- 50W (20008.7.B)

Socket



USA outlet

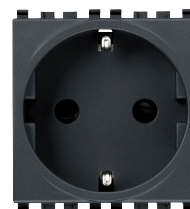

Schuko outlet



French outlet



3 PIN outlet



British outlet



Multistandard outlet

- 21B (20242)
- 21W (20242.B)

- 22B (20208)
- 22W (20208.B)

- 23B (20212)
- 23W (20212.B)

- 24B (20214)
- 24W (20214.B)

- 25B (20219)
- 25W (20219.B)

- 26B (20257)
- 26W (20257.B)

Data & Audio/Video



USB power supply unit



TV-FM-SAT socket outlet



VGA connector

- 20B (20295)
- 20W (20295.B)

- 31B (20303)
- 31W (20303.B)

- 32B (20348)
- 32W (20348.B)



TV outlet



Phone outlet



A/V connectors



UTP outlet



USB supply unit



Switch (CBs)



HDMI connector



USB outlet

- 41B (20313)
- 41W (20313.B)

- 42B (20320)
- 42W (20320.B)

- 43B (20335)
- 43W (20335.B)

- 44B (20337.6)
- 44W (20337.6.B)

- 48B (20292)
- 48W (20292.B)

- 46B (20405.06)
- 46W (20405.06.B)

- 47B (20346.H)
- 47W (20346.H.B)

- 45B (20345)
- 45W (20345.B)

(Number in brackets is original Vimar product code.)



Glass Bedside Panel

Configure bedside panel according to your request.

L (left option)

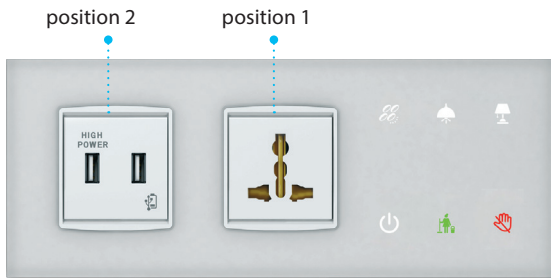

GBP3-60/WL/2F-26W-20W

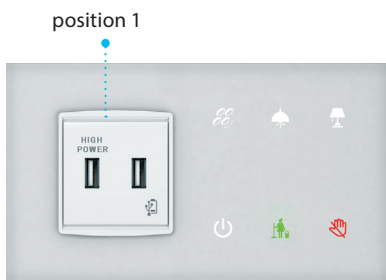

GBP3-60/WL/1F-20W

R (right option)

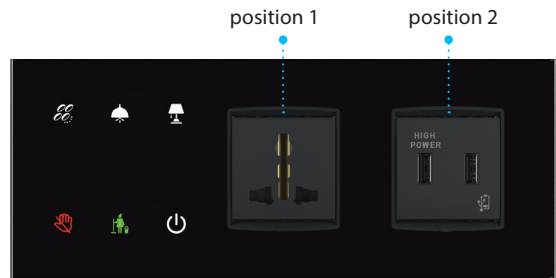

GBP3-60/BR/2F-26B-11B44B



GBP3-60/BR/1F-26B

Part number

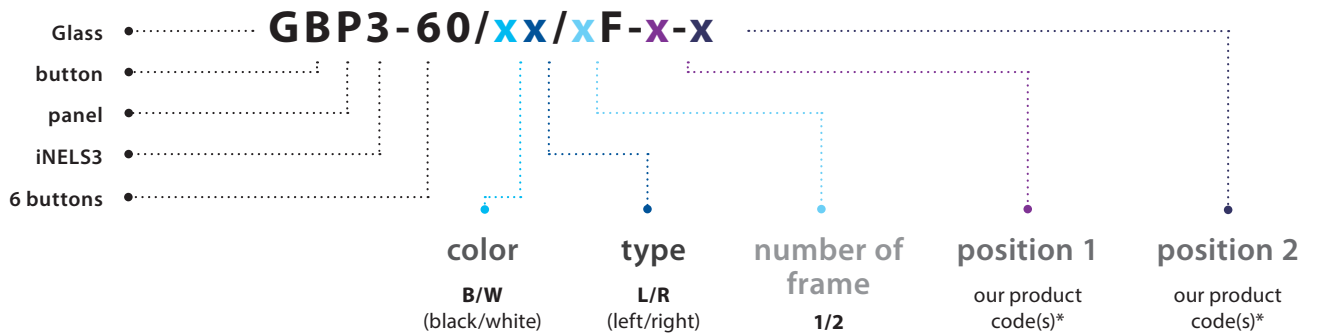

\* In case of 1-MODULE choice it is necessary to pick **2x** 1-MODULE to fill up the 1 position, for example GBP3-60/WL/1F-**21W45W**.

Classic plate



Glass white ice /2M



Glass black ice /2M



Glass black ice /3M



Glass black ice /4M

If you have any question contact our sales representative.  
For more information: [www.vimar.com/en/int/catalog/product](http://www.vimar.com/en/int/catalog/product)

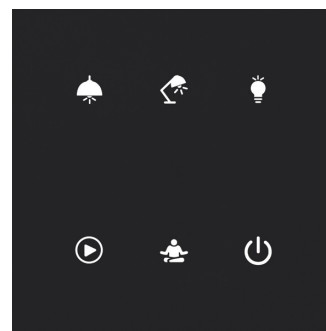
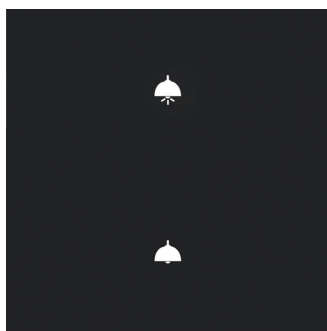

EAN code  
GSB3-20/SB: 8595188156219  
GSB3-40/SB: 8595188156233  
GSB3-60/SB: 8595188156257

### Technical parameters GSB3-20/S GSB3-40/S GSB3-60/S

#### Inputs

Temperature measuring:	YES, built-in temperature sensor
Scope and accuracy of temp. measurement:	0 to +55 °C; 0.3 °C from the range
Inputs:	2x AIN/DIN
Resolution:	by setting 10-bit
External temperature sensor:	YES, the connection between AIN1/DIN1 and AIN2/DIN2
Type of external sensor:	TC/TZ
Temperature measurement range:	-20 °C to +120 °C
Temperature measurement accuracy:	0.5 °C from the range
Illuminance sensor:	1 to 100 000 Lx

#### Buttons

Number of control buttons:	2	4	6
Type:	capacitive		
Indication:	coloured illuminated symbol		

#### Outputs

Acoustic output:	piezo-changer
Tactile output:	vibration motor

#### Communication

Installation BUS:	BUS
-------------------	-----

#### Power supply

Supply voltage/tolerance:	27 V DC, -20/+10 %		
Dissipated power:	max. 0.5 W		
Rated current:	25-35 mA	25-43 mA	25-50 mA
	(at 27 V DC), from BUS		

#### Connection

Terminals:	0.5 - 1 mm <sup>2</sup>
------------	-------------------------

#### Operating conditions

Relative humidity:	max. 80 %
Operating temperature:	-20 to +55 °C
Storing temperature:	-30 to +70 °C
Protection degree:	IP20
Overvoltage category:	II.
Pollution degree:	2
Operation position:	any
Installation:	on the wall, observing the conditions for correct installation of the thermostat

#### Dimensions and weight

Dimensions:	94 x 94 x 36 mm
Weight:	154 g

The picture of device is illustrative, the icons (symbols) are configurable by the customer.

- Glass touch controllers with symbols GSB3-20/S, GSB3-40/S and GSB3-60/S are part of a comprehensive range of glass iNELS control units and can be advantageously used in all projects for example as a part of guest room management system (GRMS).
- GSB3-20/S is equipped with two, GSB3-40/S with four and GSB3-60/S six touch buttons whose functions can easily modify by the software.
- Engraving of symbols is possible upon a request.
- Individual symbols can be illuminated in one of seven colours - red, green, blue, yellow, pink, turquoise and white.
- Glass touch panel is a design component of the iNELS system and is available in elegant black (GSB3-20/SB, GSB3-40/SB, GSB3-60/SB) and white (GSB3-20/SW, GSB3-40/SW, GSB3-60/SW) versions.
- All versions are in the size of the module (94x94 mm) from the line of luxury switches and sockets LOGUS<sup>90</sup> and are therefore fully in line with the design of frames for the sockets of this series, where you can just as for the controllers choose white and black glass frames.
- The glass touch controllers is equipped with an integrated temperature sensor. It is also equipped with two analog-to-digital inputs (AIN/DIN), which can be used to connect two potential-free contacts or one external temperature sensor TC/TZ (for example temperature measurement of the floor).
- The glass touch controllers are also equipped with a sensor of ambient light intensity. Based on information from the sensor it can switch back-light of symbols or perform various actions in the iDM3 software, for example also switch the lighting circuits in the room.
- Advantages over conventional switches/buttons are saving space, signalling the state of any system output, the ability to measure temperature as well as the ability to connect external buttons or detectors.
- Each button can control any actuator (appliance) in the system. Also, you can assign each button a different function or macro (set of functions). It is therefore possible to use one button to control several appliances at once.
- GSB3-20/S, GSB3-40/S, and GSB3-60/S are designed for mounting into an installation box.

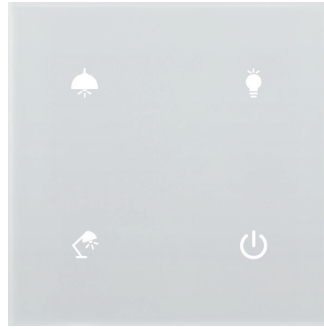

EAN code  
 GSB3-20/SW: 8595188156226  
 GSB3-40/SW: 8595188156240  
 GSB3-60/SW: 8595188156264

GSB3-20/PRO/SW: 8595188175098  
 GSB3-40/PRO/SW: 8595188175074  
 GSB3-60/PRO/SW: 8595188175050

The picture of device is illustrative, the icons (symbols) are configurable by the customer.

Connection

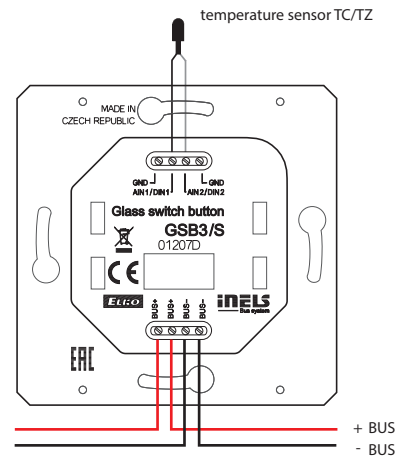
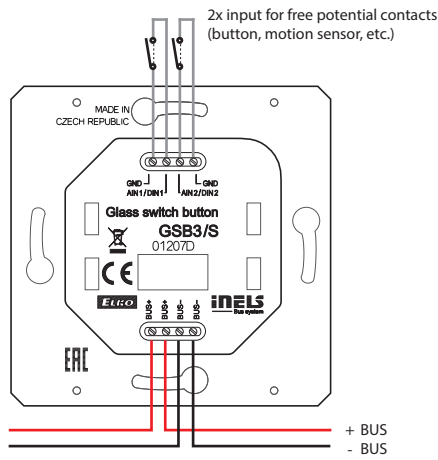

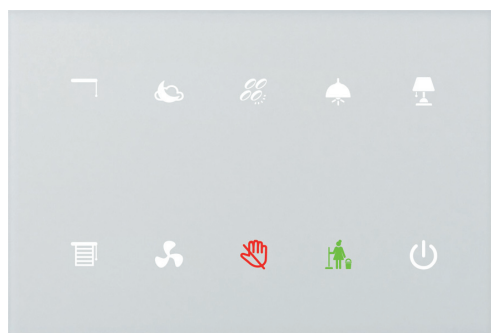
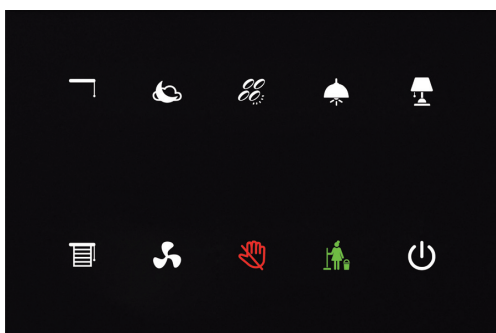

The picture of device is illustrative, the icons (symbols) are configurable by the customer.

EAN code\*  
GSP3-100/B: 8595188156288  
GSP3-100/W: 8595188156325

Technical parameters	GSP3-100
<b>Inputs</b>	
Temperature measuring:	YES, built-in temperature sensor
Scope and accuracy of temp. measurement:	0 to +55 °C; 0.3 °C from the range
Inputs:	2x AIN/DIN
Resolution:	by setting 10-bit
External temperature sensor:	YES, the connection between AIN1/DIN1 and AIN2/DIN2
Type of external sensor:	TC/TZ
Temperature measurement range:	-20 °C to +120 °C
Temperature measurement accuracy:	0.5 °C from the range
<b>Buttons</b>	
Number of control buttons:	10
Type:	capacitive
Indication:	coloured illuminated symbol
<b>Outputs</b>	
Acoustic output:	piezo-changer
Tactile output:	vibration motor
<b>Communication</b>	
Installation BUS:	BUS
<b>Power supply</b>	
Supply voltage/tolerance:	27 V DC, -20/+10 %
Dissipated power:	max. 0.5 W
Rated current:	25-65 mA (at 27 V DC), from BUS
<b>Connection</b>	
Terminals:	0.5 - 1 mm <sup>2</sup>
<b>Operating conditions</b>	
Relative humidity:	max. 80 %
Operating temperature:	-20 to +55 °C
Storing temperature:	-30 to +70 °C
Protection degree:	IP20
Overvoltage category:	II.
Pollution degree:	2
Operation position:	any
Installation:	on the wall, observing the conditions for correct installation of the thermostat
<b>Dimensions and weight</b>	
Dimensions:	142 x 94 x 36 mm
Weight:	208 g

- Glass Touch Panel GSP3-100 is part of a comprehensive iNELS series of units for the management of the hotel rooms (GRMS), but the unit can be used wherever it is required to control multiple devices from one location.
- GSP3-100 is equipped with ten touch buttons whose functions can easily be edited using the software.
- Engraving of different symbols on the unit is also possible upon a request.
- Individual symbols can be any one of seven backlight colours - red, green, blue, yellow, pink, turquoise and white.
- Glass touch panel is a design component of the iNELS system and is available in elegant black (GSP3-100/B) and white (GSP3-100/W) versions.
- Compared with standard glass touchscreen controllers with symbols GSB3-20/SB, GSB3-20/SW, GSB3-40/SB, GSB3-40/SW, GSB3-60/SB and GSB3-60/SW the GSP3-100 is one and a half times the width.
- The touch panel is equipped with an integrated temperature sensor. It is also equipped with two analogue-to-digital inputs (AIN/DIN), which can be used to connect two potential free contacts or one external temperature sensor TC/TZ (e.g. For measuring the temperature of the floor).
- The touch panel is also equipped with an ambient light intensity sensor. Based on information from the sensor it can light up indicative illumination symbols or perform various actions with the iDM3 software, e.g. To also switch the lighting circuits in the room.
- Advantages over conventional switches/buttons is saving space, signalling the state of any system output, the ability to measure temperature and an option to connect external pushbuttons or detectors.
- Each button can control any actuator (appliance) in the system. Also, you can assign a different function or macro (set of functions) to each button. It is therefore possible to use one button to control several appliances.
- GSP3-100 is designed for mounting into an installation box.

## Connection

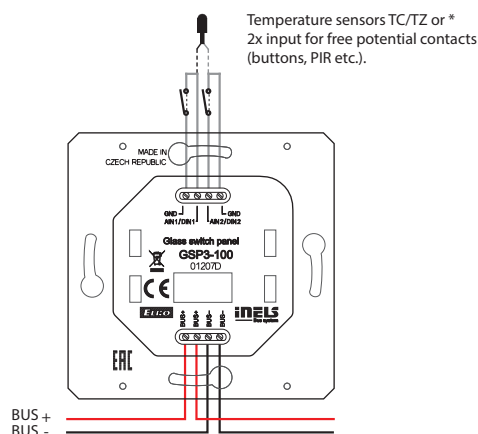

\* The choice is made in iDM3 for each unit separately.

Integration

inte

grati

on

## INELS NIAGARA &amp; FLOWBOX

powered by

niagara  
framework®

FLOWBOX

Buildings today are equipped with an array of systems to control HVAC (heating, ventilation and air conditioning), lighting, shading, security, GRMS (Guest Room Management System), energy management, emergency lighting, fire alarms, CCTV, access control systems, elevators and other technologies. Effective integration and communication among the various systems in the building is critical to creating a comfortable environment for all users, to reduce building operation costs and reduce carbon dioxide emissions required for the operation of buildings. iNELS is a great solution for a variety of jobs, particularly in the areas of lighting, shading and GRMS (Guest Room Management System), and thanks to its modular and flexible topology it is used in commercial projects of hotels, office buildings, restaurants, wellness centres or manufacturing plants and warehouses.

iNELS is fully compatible with BMS (Building Management System) Niagara and Flowbox platform, which offers a clear and efficient user interface for all - investors, management, users, operators and system integrators. iNELS with Niagara or Flowbox enables the integration of dozens of iNELS central units and all other protocols that are installed within buildings. There are controllers for the actual control of all processes in the building. Supervisor licenses for the deployment on the operator's computer are used to supervise the operation of the system, receiving alarms and notifications and evaluation of historical data and graphs. Thanks to its wide range of possible operating pre-sets, BMS allows to achieve the most economical operation of the building. User interface uses a very efficient modern design language and using of templates greatly reduces the required integration time.

Feature	iNELS <sup>®</sup> iDM	powered by niagara framework <sup>®</sup>	 FLOWBOX
programming interface	✓	✓	✓
virtual wire amount limitation	✓	✗	✗
integration of mathematical or logical functions	✗	✓	✓
third-party interconnection (ASCII or software drivers)	✓ **	✓	✓
alarm / calls / text / e-mail notifications	✗	✓	✓
support of ORACLE hospitality solution (Fidelio / Opera)	✗	✓	✗
support of multiple CU3-OxM	✗	✓	✓
SCADA interface/support	✗	✓	✓
iNELS RF interconnection (RFIO or JSON)	✓	✓	✓
iNELS Air interconnection (MQTT)	✗	✓	✓
HTML5 / JavaScript frontend - dashboards and web supervisor	✗	✓	✓
multimedia integration (CCTV, audio, video)	✗	✓ ****	✗
History logging	✗	✓	✓
SQL interconnection	✗	✓	✓

\* basic features implemented only

\*\* partial support: via ASCII or selected drivers only

\*\*\* partial support: calls and texts only

\*\*\*\* partial support: CCTV only

**CORE FEATURES:**



**A wide range of logical function blocks**

BMS systems offers integrators dozens of function blocks for solving a variety of tasks within the building management. Function blocks are also divided into clear categories for easy navigation.

**Supports virtually all universal protocols**

Niagara and Flowbox are really versatile and supports dozens of universal and proprietary protocols, all the data points converted to a universal form, allowing truly free integration between all protocols.

**Multiplatform approach**

By leveraging HTML5 Niagara and Flowbox offers a simple interface that eliminates the need to install various plugins. A unified user interface is available for all platforms - PC, tablet or mobile phone.

**Advanced visualization**

Part of BMS systems is an extensive graphics library for creating modern and well-arranged visualizations depicting the current state of the controlled technology.

**Creating graphs/trends**

Part of the visualizations is graphs that enable easy insertion of the monitored data to a chart by using "drag and drop" allowing more transparent comparison of values and storing graphs for later use.

**Customizable dashboards**

Within the visualizations, dashboards are widely supported, which can also be accessed with dependant on the user rights and users are able to adapt these dashboards, e.g. monitored variables, according to their requirements. Each user can inspect the operation of buildings from different view and BMS freely enables effective adaptation.

**Management of alarms and notifications**

Sophisticated alarm and notification management including the ability to send information via e-mail. Alarms can be backed up and user notes can be inserted to the individual alarms, for example on how to resolve the situation.

**Energy analysis**

Energy management and cost analysis is the most important part of building management. BMS systems offer huge tracking capabilities and evaluating parameters related to energy consumption.

**Archive logs and historical data**

All historical data and logs can be stored at freely selectable intervals. The big advantage of BMS systems is that it allows all alarms, logs, visualization, calendars and configuration to be done by remote using a standard Web browser.

**Encrypted communication**

Authentication requires the use of very strong credentials and all data communication is encrypted and this area is with the advent of the Internet of things (IoT) is given maximum attention.

**Wide range of access for rights management**

The big advantage of this solution is Niagara or Flowbox control access based on user roles, which enables users to perform only the well-defined actions given. All changes and events are also logged and stored for possible evaluation.

**Efficient navigation through the use of tags**

Utilising tags streamlines the entire process, from configuration to management of the whole system. Using tags in combination with templates can significantly reduce configuration time; tags facilitate access control based on user rights, navigation in the whole project and user customization in the visualization.



PC



Notebook



Tablet



Smartphone

**BMS**  
Building management system



powered by  
**niagara**  
framework®



**XML**

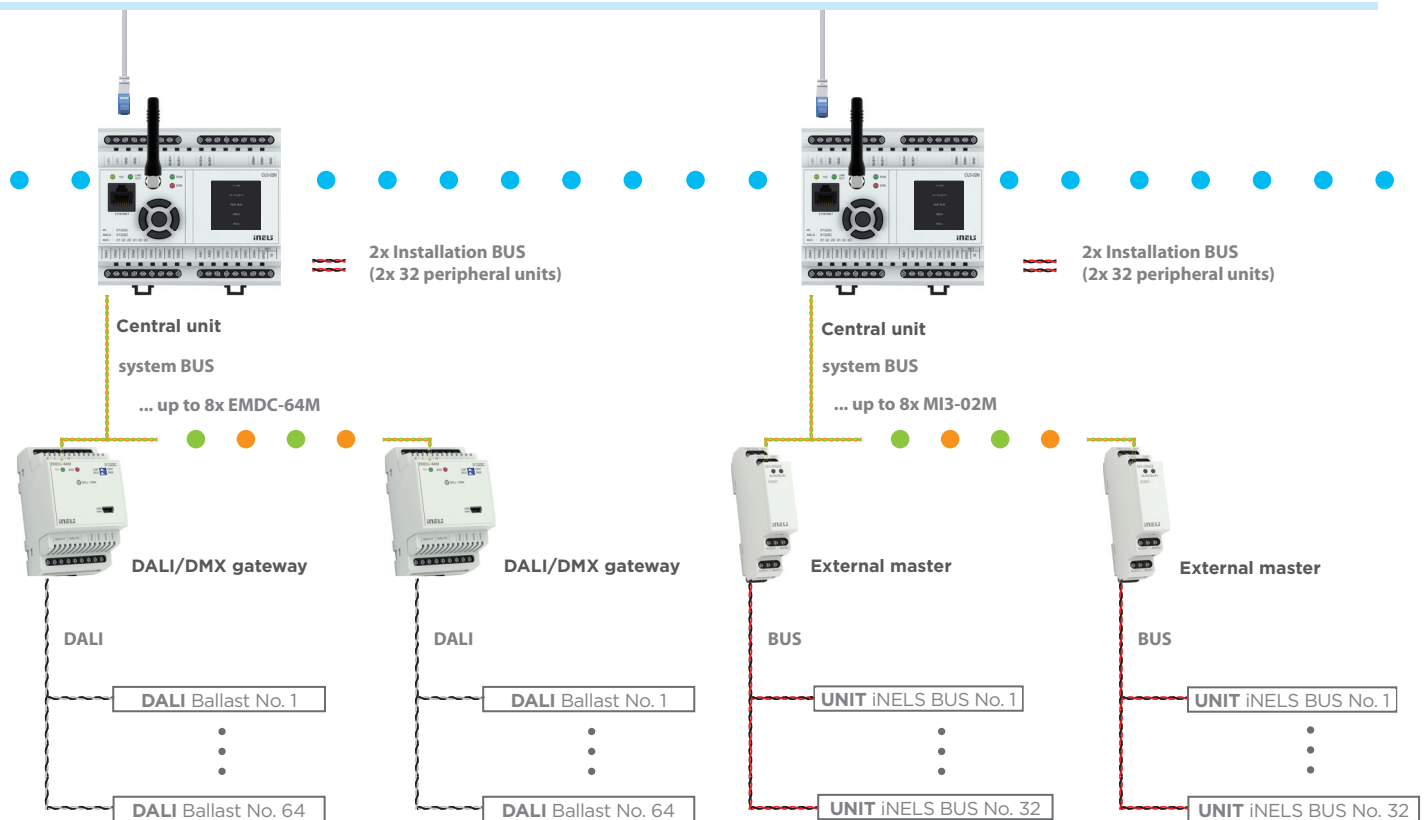

**AVAILABLE PROTOCOLS: \***



\* A complete list can be found on [www.inels.cz](http://www.inels.cz).





EAN code  
HOME ASSISTANT 8464  
EAN: 8595188184649

Technical parameters	Home Assistant GW
Power:	MicroUSB 5 V/MicroUSB 5 V/2 A
Video output:	HDMI
Audio output:	3.5 mm stereo JACK out
Processor (CPU):	1.2 GHz, 64-bit quad-core, ARM Cortex-A 53
Memory (SDRAM):	1 Gb
Communication interface:	ethernet port 10/100 Mbps (RJ45)
Connect peripherals:	4x USB 2.0
Dimensions (ŠxVxH):	90 x 70 x 25 mm

- Home Assistant GW works as a server for connecting third-party devices and integrating them into the iNELS environment.
- The server uses the open Home Assistant platform, which includes more than 1000 already Existing Integration. Platform them Supported own community a count Integration with constantly Growing. Thanks to Open Source ar if necessary, it is possible to create your own integration driver for new device.
- Home Assistant GW communicates via iNELS IP protocol, so it can be controlled via a mobile application or a superior unit CU3-IPMASTER.
- The Home Assistant GW uses Raspbery Pi hardware. Also included is an SD card with pre-installed Linux operating system and the necessary software.

Infrastructure example

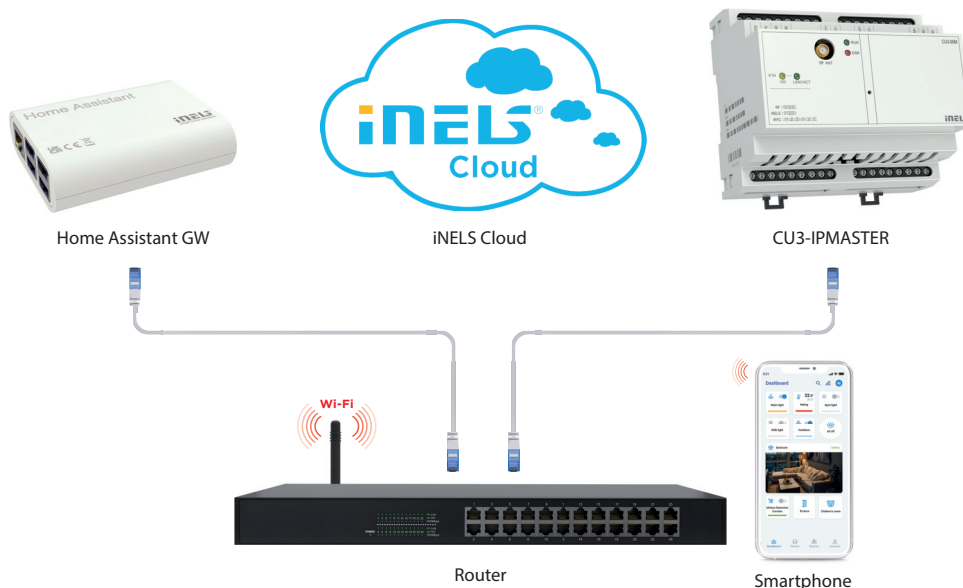



EAN code  
Connection Server: 8595188149204

Technical parameters	Connection Server
Connection:	MicroUSB 5 V/MicroUSB 5 V/2 A
Video Output:	HDMI
Audio Output:	3.5 mm stereo JACK out
Processor (CPU):	1.2 GHz, 64-bit quad-core, ARM Cortex-A 53
Memory (SDRAM):	1 Gb
Communication Interface:	ethernet port 10/100 Mbps (RJ45)
Connecting peripherals:	4x USB 2.0
Dimensions:	90 x 70 x 25 mm

- The connection server is providing a communication environment between iNELS BUS System with the third party devices, for which their protocols are also translated and submitted.
- The iHC application's environment enables us to control all these technologies from just one app.
- If the connection server is present in the installation, then it enables option for controlling the installation by application - lighting, blinds, heating, etc., also IP cameras, air conditioning, recuperation or domestic appliances Miele.
- It also allows the communication with the domestic voice intercom 2N. It can also arrange the information from the weather station Giom or data from energy meters (electricity, water, gas), which is visualized in clear graphs.
- The device connection server uses the Raspberry Pi hardware and the apps requires a license relative to the MAC address of the device.
- While connecting with the devices connection server, it's recommended to use an uninterruptible power supply (UPS), which ensures that, there will be no power outage.
- As a part of the package, we also included an SD card where we previously installed Linux OS on it and its needed software equipment.
- The configuration is happening on its own web interface, where the default IP address is not fixed. (The IP address is assigned from the DHCP server and it's needed to be known when we're connected to the network).

**These protocols are being translated:**

- XML RPC (for communication with iHC applications, Connection Server controls access to the central unit of iHC applications and allows access to it from multiple devices).
- ELKONET (for communication with the iNELS central unit).
- Miele@home 2.0 (for the communication with Miele Gateway and the domestic needs).
- VAPIX2, VAPIX3, ONVIF for cameras (which enables streaming up to 9 camera pictures together, PTZ controlling, recording on a network drive).
- Coolmaster (for communication with AC Daikin VRF, Sanyo VRF, Toshiba VRF, Mitsubishi Electric VRF, LG VRF, Fujitsu VRF, Mitsubishi Heavy VRF, Hitachi VRF).
- Atrea, AirPohoda (recuperation).
- NILAN (indoor climate solutions).
- SIP for domestic voice communication, for example: 2N (a communication between the iHC app or between individual iHC apps - VoIP).
- Giom3000 (displaying values from the weather station in the iHC app and using the information about the temperature, humidity and wind speed to an subsequent event, for example removing the shutters).

**Infrastructure example**

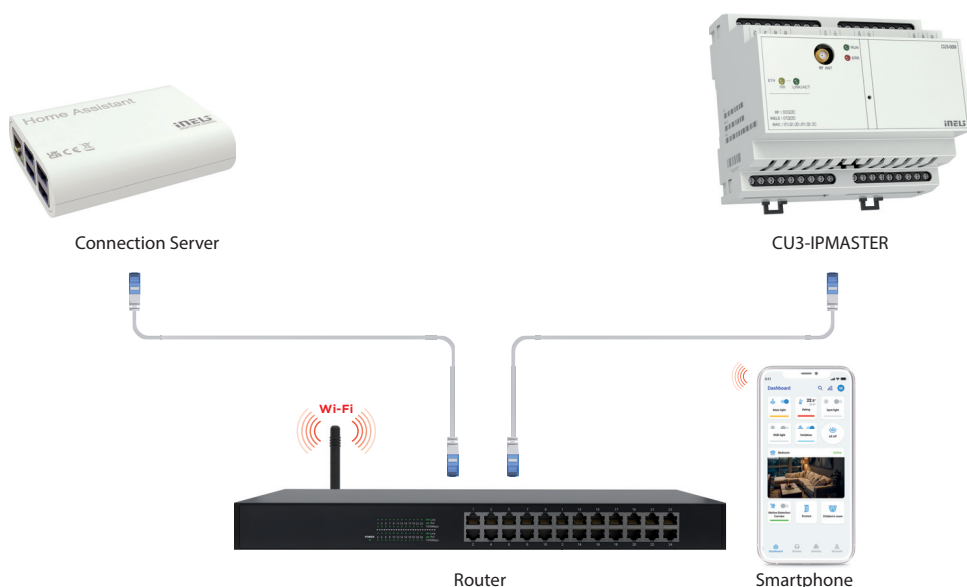



EAN code  
eLAN-IR-003: 8595188132831

**Technical parameters** **eLAN-IR-003**

**Senzor IR - learning mode**

Senzor IR:	infrared sensor for learning IR codes
The carrier IR frequency:	20 - 455 kHz
Learning distance:	till 1 m

**Outputs**

Output:	3x IR transmitter
Connection:	3x 3.5 Jack connector, cable length 3 m
Output indication:	3x LED green status IR1-IR3
Range:	Up to 1 m from the device

**Ethernet communication**

Indication of ETH operating status:	green LED
Indic. of ETH communication:	yellow LED
Communication interface:	10/100 Mbps (RJ45)
Default IP address:	192.168.1.1

**Power supply**

Voltage supply/jm. current:	10-27 V DC/200 mA (safe low voltage)
Connection:	Jack connector Ø 2.1 mm
Voltage supply indication:	green LED

**Other data**

Other possibilities of wiring:	USB-B connector
Indication:	yellow USB LED status
Reset button:	settings to their default values
Power supply:	230 VAC/12 V DC supplied with the data logger

**Operating conditions**

Operating temperature:	-20 to +55 °C
Storage temperature:	-25 to +70 °C
Protection degree:	IP30
Pollution degree:	2
Operation position:	arbitrary
Installation:	free
Design:	design box

**Dimensions and weight**

Dimensions:	90 x 52 x 65 mm
Weight:	136 g

- The applications iHC-MAIR and iHC-MIIR provide universal control for all Audio/Video devices (including air conditioning).
- The application is connected via smart phone connected to the smart IR box eLAN-IR-003, which communicates with audio/video devices via IR sensor.
- The intuitive application environment makes it simple for anyone to control.
- What all can you control? Home theater, TV, DVD or Blue Ray player, amplifier, set-top box, satellite receiver, air-conditioning, projector and more.
- It can control up to 100 arbitrary commands with various controllers that you normally have at home.
- With the scenes function you can perform multiple functions simultaneously by a single click command (e.g. you are going to bed you and switch off all AV appliances in the entire home with a single press).
- It is possible to integrate into a single application an unlimited number of IR boxes, meaning that in one application, you have control over the living room, children's rooms, etc.
- It is also possible to control remotely from anywhere using a Wi-Fi network (e.g. from work or vacation).
- Thanks to auto-IP acquisition from the DHCP server, you need not set up a network (if you have no set fixed IP address).
- You can connect three sensors to the smart IR box eLAN-IR-003 for three directions of control.

**Example of connection**

**The front panel**

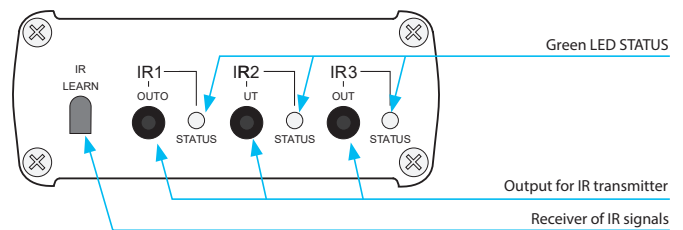

**The back panel**

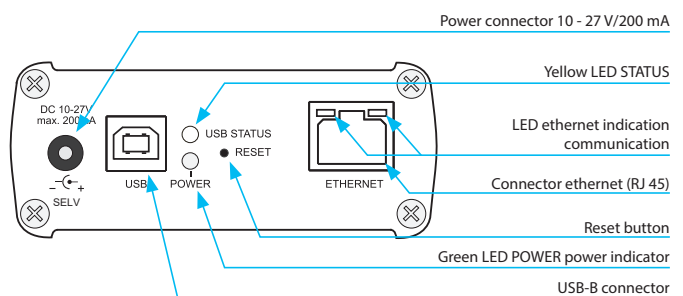

**Controller options menu in the application**





EAN code  
eLAN-RS485/232: 8595188170260

## Technical parameters eLAN-RS485/232

### Interface Ethernet

ETH operating status indicator:	green LED
ETH communication indicator:	yellow LED
Communications interface:	100 Mbps (RJ45)
IP address support:	static, DHCP client
Factory setting:	DHCP client

### Interface RS485

Broadcast indication:	red LED
Connector:	PUSH IN max 1.5 mm <sup>2</sup>
Bus termination on the eLAN-RS side:	120 Ω resistor (implemented inside the eLAN-RS485/232)
Range:	500 m (depending on used cable and communication speed)
Communication speed:	adjustable, max. 230.4 Kbps
Max. connection:	32 devices
Communication:	half-duplex transmission
Type of communication:	MODBUS - RTU, TCP - RS485 Bridge, EZS Jablotron, Air Pohoda, LG PI485, Daikin RTD-NET, Cairox, Mitsubishi Melcobems MINI, Misolsr
Parity setting:	none, odd, even
Length:	5/6/7/8 bit
Stop bit:	1/2

### Interface RS232

Broadcast indication:	red LED
Connector:	PUSH IN max 1.5 mm <sup>2</sup>
Range:	50 m (depending on used cable and communication speed)
Communication speed:	adjustable, max. 230.4 Kbps
Max. connection:	1 device
Communication:	full-duplex transmission
Type of communication:	MODBUS - RTU, TCP - RS232 Bridge, EZS Paradox, Aseko
Parity setting:	none, odd, even
Length:	5/6/7/8 bit
Stop bit:	1/2

### Power supply

Indication:	yellow LED STATUS
Supply voltage/current:	10-27 V DC/200 mA SELV
Power:	adapter with connector Jack Ø 2.1 mm (part of supply) Passive PoE or connector USB-B
Supply voltage indication:	green LED POWER
Button RESET:	To factory settings
Power source:	230 V AC/12 V DC supplied with the data logger

### Operating conditions

Operating temperature:	-20 to +55 °C
Storage temperature:	-25 to +70 °C
Protection degree:	IP20
Pollution degree:	2
Operation position:	arbitrary
Installation:	free
Design:	design box

### Dimensions and weight

Dimensions:	90 x 52 x 65 mm
Weight:	110 g

- The eLAN-RS485/232 is used to communicate with devices communicating via the Modbus RTU protocol, with the converter acting as a master unit.
- eLAN-RS485/232 is equipped with a web interface to configure the connected devices.
- Thanks to the web interface, the eLAN-RS485/232 can be used as a stand-alone device.
- eLAN-RS485/232 is integrated into the Connection Server, which makes it possible to control the connected technology through iNELS Home Control (iHC). Thus, it is possible to control, for example, ventilation systems and heat recovery from NILAN.
- It can be also used as a converter for data conversion from ESS systems like Jablotron or Paradox.
- The eLAN-RS485/232 is equipped with A, B and GND terminals for connection to the RS485 serial line on the back panel, as well as a signalling diode to indicate the status.
- The front panel features an RJ45 connector to connect to the Ethernet via a network cable.
- The power supply of the eLAN-RS485/232 is possible via a 10-27 V DC adapter (adapter included) or through a 24 V DC PoE, e.g. directly from a switch or PoE injector.
- The eLAN-RS485/232 requires the RS485 serial interface to be connected in line and to comply with all policy and installation requirements of this interface.

### Example of connection

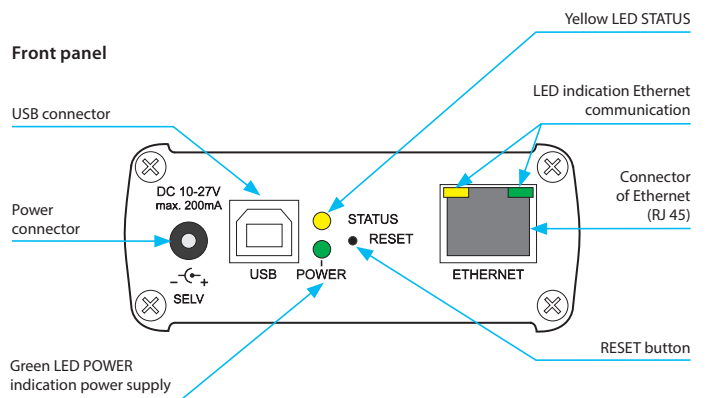

### Back panel

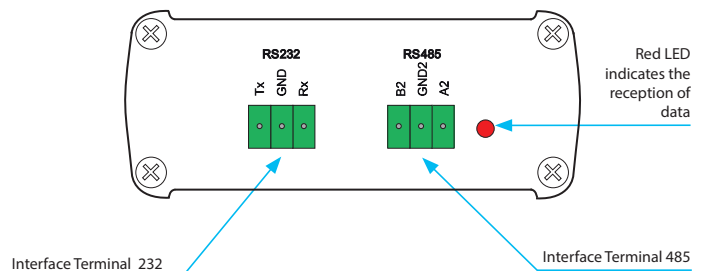

Multimedia

multi

me

dia



Radio



Music

Video-  
telephone

Intercom



Audiozone

**Technical parameters****LARA Radio****Internet Radio**

Supported data transfer formats:	mp3, ogg, acc
----------------------------------	---------------

**Control/Settings**

Front panel:	touchscreen buttons
Communication Ethernet:	via PC setting up and communicating SW LARA Configurator
Button RESET:	restart product/ reset product to factory settings

**Interface ethernet**

Communications interface:	10/100 Mbps
Connector:	RJ45
Max. cable length UTP with power:	50 m

**Display**

Type:	color OLED
Resolution:	128 x 128 pixels
Visible surface:	26 x 26 mm

**Power supply**

Supply:	Passive PoE 24 V DC/1.25 A
Min. input:	1.4 W
Max. input:	26 W (peak at maximum playback performance)

**Amplifier**

Amplifier:	stereophonic class D with digital output control
Max. amplifier output:	2 x10 W/8 Ω

**Inputs/Outputs**

Microphone:	NO
Audio input:	3.5 stereo jack
Audio output 1:	terminals LINE OUT (used for external amplifier)*
Audio output 2:	terminals OUT L/OUT R (speaker output from int. amplifier)

**Connection**

Terminal block:	0.5 - 1 mm <sup>2</sup>
-----------------	-------------------------

**Other data**

Working temperature:	0 to + 55 °C
Protection degree:	IP20
Overvoltage category:	II.
Pollution degree:	2
Installation:	in an installation box

**Dimensions and weight**

Dimensions:	
- plastic:	85 x 85 x 46 mm
- metal, glass, wood, granite:	94 x 94 x 46 mm
Weight:	209 g (plastic frame)

\* The cable from the LINE OUT terminals must be shielded, max. length should not exceed 5 m.

- A music and internet radio player - all in the dimension of a switch and a luxurious LOGUS<sup>90</sup> design.
- LARA Radio - when connected to the Internet, it can play streaming radio stations and you can store up to 40 of them. But you can also select from thousands of radio stations from across the globe, which provide data for correct connection.
- LARA Radio can play content from an external music source, which can be a smart phone or e.g. an MP3 player. These devices are connected to a 3.5mm stereo jack audio input, located underneath the front panel.
- Touch control is performed on the device front panel (six capacity buttons available), or LARA Dio.
- The basic device settings (network connection, language, audio input) are performed via the display and a simple menu controlled from capacity buttons on the device front cover. Further settings (selection of stations, connection with the server, updating firmware, etc.) are configured via computer and the software LARA Configurator.
- LARA Radio is equipped with an OLED colored display with the size of 1.5". The display also shows basic information about playing music, which also serves the orientation in the menu settings, etc.
- LARA Radio has an integrated amplifier with 2x 10 W output, thus greatly facilitating device installation in places where such output suffices. LARA is used e.g. to provide premium sound to the kitchen, bathrooms, waiting rooms, offices, reception desks, entrance halls, operating rooms or wellness facilities.
- LARA is powered by PoE with maximum voltage level 27 V DC/ 1000 mA. So connecting and communicating with just one cable (UTP) is a major advantage.
- For LARA, an entire series of accessories is ready for connection (PoE adapters, PoE switches), speakers (in a frame, walls or ceilings) and installation (cables, box, etc.).
- Complies with standards IEEE 802.3u (100BASE-Tx).
- Automatic cable crossing detection of Ethernet cable - MDIX.

**EAN code**

LARA Radio white:	8595188148719
LARA Radio ivory:	8595188149242
LARA Radio ice:	8595188149228
LARA Radio pearl:	8595188149259
LARA Radio aluminium:	8595188149211
LARA Radio grey:	8595188149235

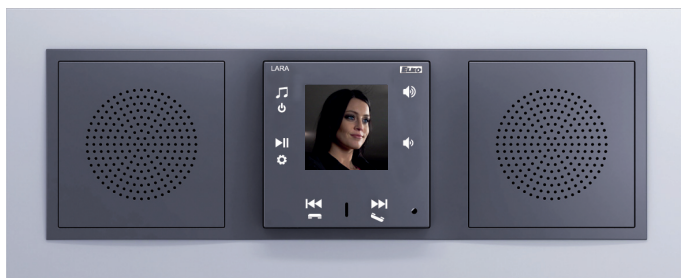
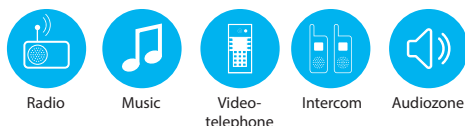

Technical parameters	LARA Intercom
<b>Internet Radio</b>	
Supported data transfer formats:	mp3, ogg, acc
<b>Control/Settings</b>	
Front panel:	touchscreen buttons
Communication Ethernet:	via PC setting up and communicating SW LARA Configurator
Button RESET:	restart product/ reset product to factory settings
<b>Interface ethernet</b>	
Communications interface:	10/100 Mbps
Connector:	RJ45
Max. cable length UTP with power:	50 m
<b>Display</b>	
Type:	color OLED
Resolution:	128 x 128 pixels
Visible surface:	26 x 26 mm
<b>Power supply</b>	
Supply:	Passive PoE 24 V DC/1.25 A
Min. input:	1.4 W
Max. input:	26 W (peak at maximum playback performance)
<b>Amplifier</b>	
Amplifier:	stereophonic class D with digital output control
Max. amplifier output:	2 x10 W/8 Ω
<b>Inputs/Outputs</b>	
Microphone:	YES
Audio input:	3.5 stereo jack
Audio output 1:	terminals LINE OUT (used for external amplifier)*
Audio output 2:	terminals OUT L/OUT R (speaker output from int. amplifier)
<b>Connection</b>	
Terminal block:	0.5 - 1 mm <sup>2</sup>
<b>Other data</b>	
Working temperature:	0 to + 55 °C
Protection degree:	IP20
Overvoltage category:	II.
Pollution degree:	2
Installation:	in an installation box
<b>Dimensions and weight</b>	
Dimensions:	
- plastic:	85 x 85 x 46 mm
- metal, glass, wood, granite:	94 x 94 x 46 mm
Weight:	209 g (plastic frame)

\* The cable from the LINE OUT terminals must be shielded, max. length should not exceed 5 m.

- LARA Intercom offers users 5 different functions and expands even more options to Lara Radio - music players and internet radio stations within the range of LOGUS<sup>90</sup> switch designs.
- LARA Intercom provides an extra functionality and videophone intercom.
- Thanks to videophone function, now it is possible to have a voice communication between LARA and the sound of the door (IP Intercom), so with someone visiting and standing in front of the house, we can see that on LARA display as part of this function which increases the security feeling and safety besides of course, the comfort for the user.
- LARA Intercom is equipped with an OLED colored display with the size of 1.5", which is used to transfer images and sounds from the door camera properly. The display also shows basic information about playing music, which also serves the orientation in the menu settings, etc.
- The intercom function can also be used for communications between all the family members throughout the whole house, thanks to two way voice communications possibilities between different LARA units.
- LARA Intercom continues to offer three functions that are also supported by LARA Radio - when connected to the Internet, it can play streaming radio stations and you can store up to 40 of them. But you can also select from thousands of radio stations from across the globe, which provide data for correct connection.
- LARA Intercom can play content from an external music source, which can be a smart phone or e.g. an MP3 player. These devices are connected to a 3.5mm stereo jack audio input, located underneath the front panel. You can also use LARA for streaming your favorite music from Spotify Premium.
- Touch control is performed on the device front panel (six capacity buttons available), or LARA Dio.
- The basic device settings (network connection, language, audio input) are performed via the display and a simple menu controlled from capacity buttons on the device front cover. Further settings (selection of stations, connection with the server, updating firmware, etc.) are configured via computer and the software LARA Configurator.
- LARA Intercom has an integrated amplifier with 2x 10 W output, thus greatly facilitating device installation in places where such output suffices. LARA is used e.g. to provide premium sound to the kitchen, bathrooms, waiting rooms, offices, reception desks, entrance halls, operating rooms or wellness facilities.
- LARA is powered by PoE with maximum voltage level 27 V DC/ 1000 mA. So connecting and communicating with just one cable (UTP) is a major advantage.
- For LARA, an entire series of accessories is ready for connection (PoE adapters, PoE switches), speakers (in a frame, walls or ceilings) and installation (cables, box, etc.).
- Complies with standards IEEE 802.3u (100BASE-Tx).
- Automatic cable crossing detection of Ethernet cable - MDIX.

#### EAN code

LARA Intercom white:	8595188149389
LARA Intercom ivory:	8595188149419
LARA Intercom ice:	8595188149396
LARA Intercom pearl:	8595188149426
LARA Intercom aluminium:	8595188149372
LARA Intercom grey:	8595188149402

Touchscreen operation

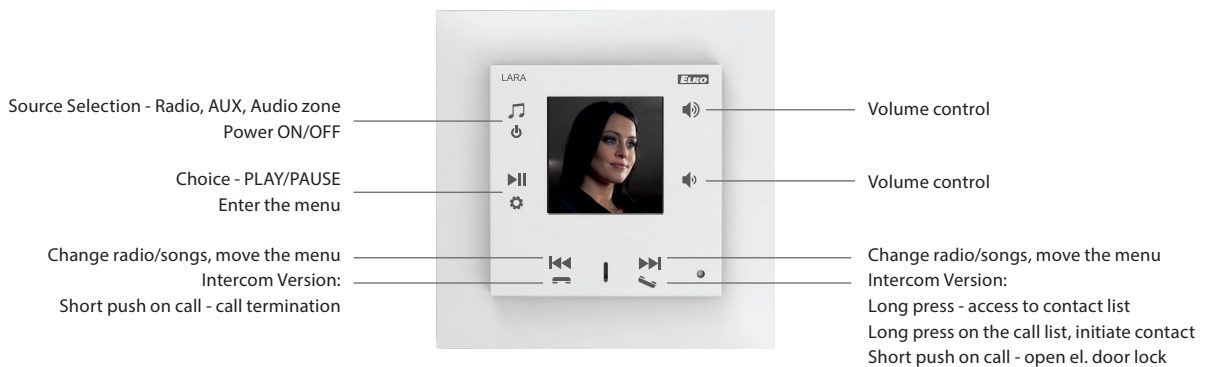

Applications control

Operations, using the application for, LARA Dio and iNELS Home Control for Android and iOS smartphones and tablets.

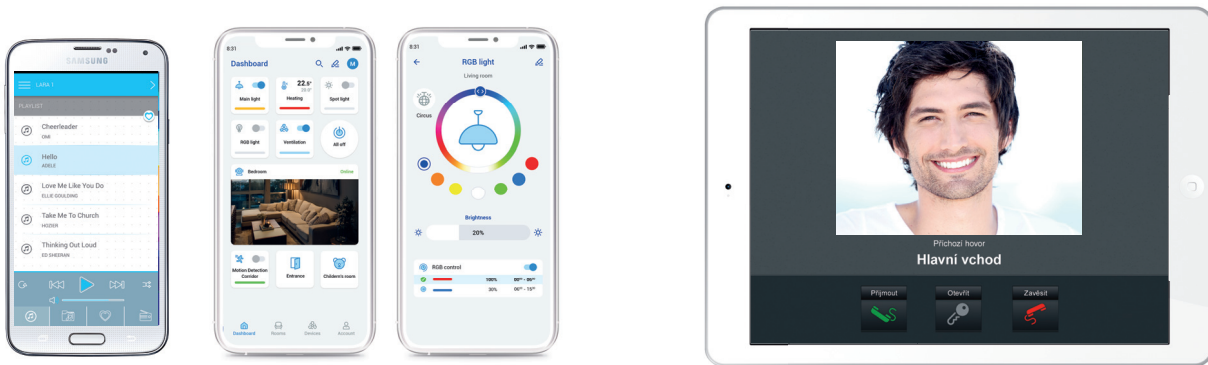

Wiring example

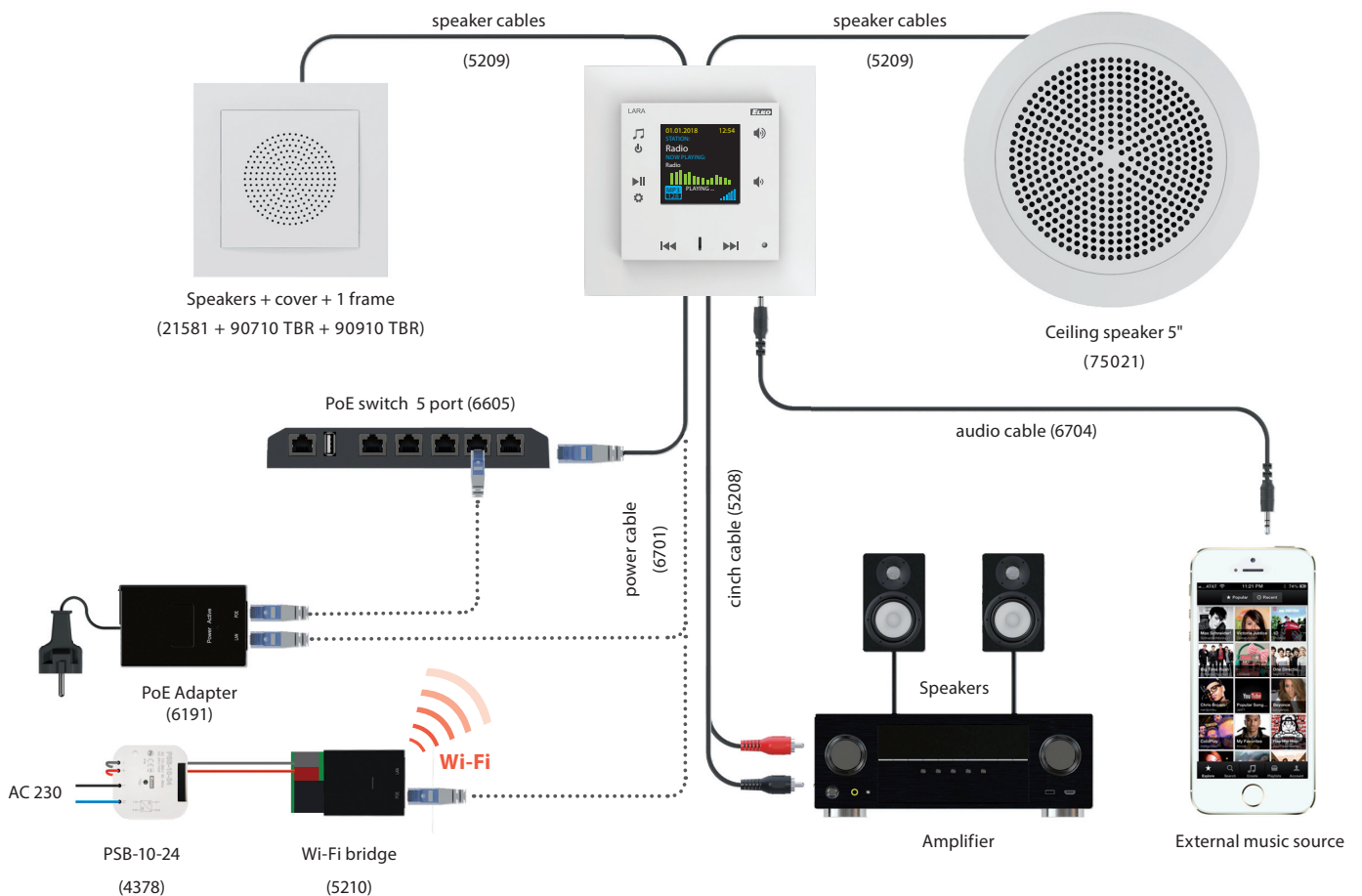







Speakers and cables

	<b>AUX CABLE LARA (LARA CINCH CABLE)</b> Used to connect LARA with exter. amplifier. Reduction 4pin from LARA LINE OUT to 2x CINCH plug into amplifier, length 2 x 20 cm.	5208
	<b>POWER SUPPLY (PSB-10-24)</b> Switching stabilized power supplies with fixed output voltage, intended for mounting into an installation box (e.g. KU-68). PSB-10-24 - stabilized power supply 24V/10 W.	4378
	<b>AUX CABLE LARA (LARA AUDIO CABLE)</b> Used to connect LARA with external music source (smart phone mp3 player). The length is 20 cm terminated with 2x stereo jack 3.5 mm.	6704
	<b>CEILING SPEAKER</b> Speaker is suitable for the installation in suspended ceilings and hollow walls. Mounting hole diameter 143 mm, Power 8 W, 32 Ω speaker impedance.	75021 CBR
	<b>SURFACE SPEAKER</b> Two-way speaker intended for mounting in a ceiling or on the walls: Power 15 W, 32 Ω speaker impedance, dimensions 270x183x37 mm. Color: White	75106 CBR
	<b>NETWORK CABLE, 0.2 m</b> Flat white LAN cable CAT5, length 20 cm, terminated with 2x RJ45 plugs.	6702
	<b>NETWORK CABLE, 1 m</b> Flat white LAN cable CAT5, length 1 m, terminated with 2x RJ45 plugs.	6700

Power supply and network

	<b>WI-FI BRIDGE</b> Used for LARA wireless connection via WiFi network.	5210
	<b>PoE SWITCH - 5x RJ45</b> Provides LAN connectivity and PoE power supply for up to 5 x LARA.	6605
	<b>PoE SWITCH - 8x RJ45</b> Provides LAN and connected PoE of up to 8x LARA. In addition to the 24 V PoE also offers a 48 V PoE for the power supply of 2N.	6606
	<b>NAS EXTERNAL STORAGE</b> Two-chamber NAS server with the function of hosting, sharing and data security.	7212

Power sets

	<b>POWER SUPPLY PoE + WiFi INTO OR THE BOX</b> WiFi bridge with PoE and power supply into an installation box. Power supply 230 V.	5224
	<b>POWER SUPPLY PoE INTO A BOX</b> PoE injector with power supply intended for an installation box. Power supply 230 V.	5226
	<b>PoE SUPPLY</b> Power injector with plug-in adapter 230 V.	5225
	<b>POWER SUPPLY PoE + WiFi</b> WiFi bridge with PoE plug in adapter 230 V.	5227

Installation material

	1-FRAME	90910 TBR
	2-FRAME	90920 TBR
	3-FRAME	90930 TBR
	4-FRAME	90940 TBR
	5-FRAME	90950 TBR
	SURFACE MOUNT BOX	10976 ABR
	INSTALLATION BOX 1 GANG (KP 67/2)	6705
	INSTALLATION BOX 2 GANG (KP 64/2)	6706
	INSTALLATION BOX 3 GANG (KP 64/3)	6707
	INSTALLATION BOX 4 GANG (KP 64/4)	6708
	INSTALLATION BOX 5 GANG (KP 64/5)	6709
	INSTALLATION BOX 1 GANG (KP 64/LD)	6710
	INSTALLATION BOX 2 GANG (KP 64/2L)	6711
	INSTALLATION BOX 3 GANG (KP 64/3L)	6712
	INSTALLATION BOX 4 GANG (KP 64/4L)	6713
	INSTALLATION BOX 5 GANG (KP 64/5L)	6714
	UNIVERSAL BOX 1068-02	6716
	UNIVERSAL BOX KUH 1/L NA	6717

2N Helios IP Verso



2N Helios IP Base



The application allows you to easily control connected devices such as socket switching, dimming of lights, control of blinds or garage doors, control of heating circuits and compatible air conditioning. Of course, the display of available values, such as temperature, the status of a motion, window, door or flood detectors, or the current status of all controlled devices.

It now brings a clear Dashboard, on which it is possible to display the most used devices, previews of connected cameras or created scenes. With one click, you can control several devices at once.

The iNELS application will gradually be supplemented with the possibility to connect new devices, new systems and central units as well as third-party devices. Enter a whole new stage with the new iNELS mobile application, expanding the functions and integration options of the iNELS 2022 system.

		Fáze 1	Fáze 2	Fáze 3
<b>Electroinstallation</b>    	Lighting control	✓	✓	✓
	Garage doors and gates	✓	✓	✓
	Switching appliances	✓	✓	✓
	RGB bulbs and LED strips	✓	✓	✓
	Scenes	✓	✓	✓
	Detectors/sensors	✓	✓	✓
 <b>HVAC</b>	Heating	✓	✓	✓
	Air conditioning	✗	✓	✓
	Recuperation	✗	✓	✓
 <b>Audio</b>	LARA	✗	✓	✓
	NAS	✗	✗	✓
 <b>3<sup>rd</sup> party</b>	Cameras	✓	✓	✓
	Weather station	✗	✓	✓
	Intercoms	✗	✓	✓
	Home appliances	✗	✗	✓
 <b>Energy management</b>	Energy dashboard	✗	✓	✓
	History report (charts & graphs)	✗	✗	✓
 <b>Voice assistants</b>	Google Home	✓	✓	✓
	Amazon Alexa	✓	✓	✓
 <b>Others</b>	Automation	✗	✓	✓
	Notification	✗	✓	✓
	Widgets	✗	✓	✓
	Favourites/overview	✓	✓	✓
	Log history	✗	✓	✓
	eLAN-IR	✗	✓	✓
	Geolocation	✗	✓	✓
	Weather data	✗	✓	✓
	Home Assistant	✗	✓	✓
	Users management	✓	✓	✓

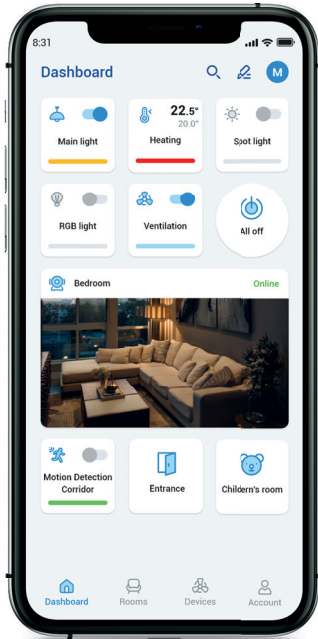

### Dashboard

Absolute control over the state of all technologies.

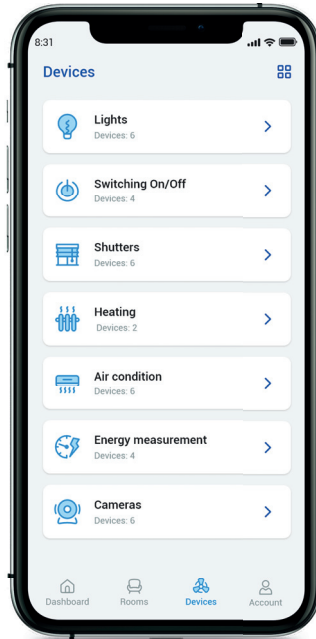

### Device list

Control the device from anywhere.

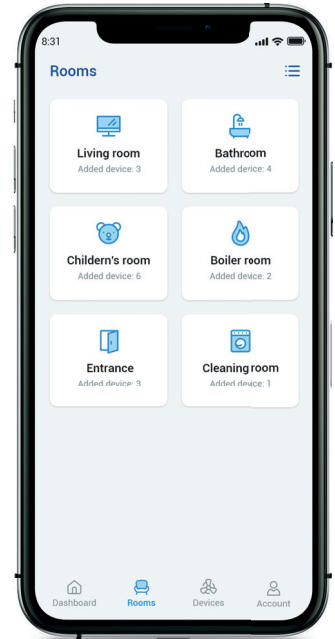

### Rooms management

Settings according to individual rooms.

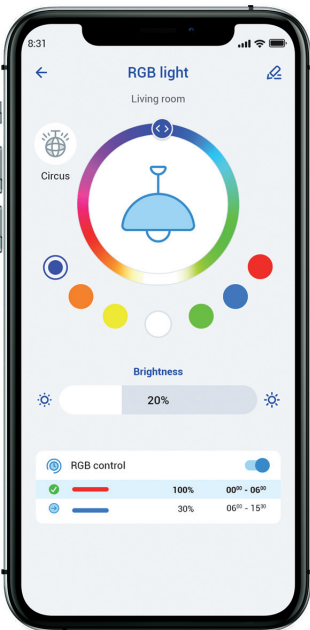

### Colour setting

Easy adjustment of the light scene with one touch - switching, dimming, colour.

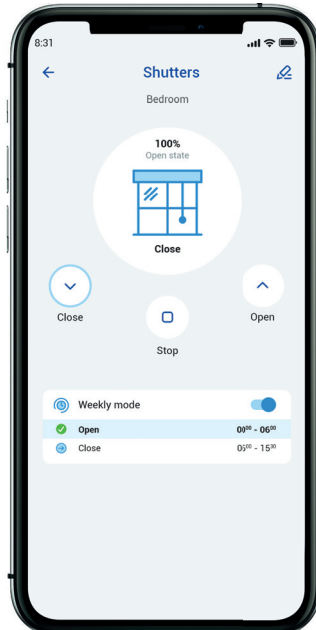

### Shutters/Blinds

Possibility of individual or joint control of shading technology.



### Temperature

You can set the temperature in each room exactly as you like.



iNELS Accessories

acce

ss

ries



EAN code  
 Telva-2 230V, NC: 8595188181976  
 Telva-2 230V, NO: 8595188181969  
 Telva-2 24V, NC: 8595188181990  
 Telva-2 24V, NO: 8595188181983

Technical parameters	TELVA 230V		TELVA 24V	
	NO	NC	NO	NC
Operating voltage:	230 V, 50/60 Hz		24 V, 50/60 Hz	
Switching current max:	300 mA		500 mA	
Operating current:	13 mA		100 mA	
Closing/opening time:	3–5 min		3–5 min	
Power input:	2.9 W		2.4 W	
Protection:	IP54		IP54	
Settings:	4 mm (0.16")		4 mm (0.16")	
Stopping force:	90–110 N		90–110 N	
Cable length:	800–1000 mm (31–39")		800–1000 mm (31–39")	
Connecting wire:	2 x 0.75 mm <sup>2</sup>		2 x 0.75 mm <sup>2</sup>	
Media temperature:	-5 °C to 60 °C (23 to 140 °F)		-5 °C to 60 °C (23 to 140 °F)	
Colour:	white RAL 9003		white RAL 9003	
Dimensions h/w/d:	63 x 42 x 45 mm (2.5 x 1.7 x 1.8")		63 x 42 x 45 mm (2.5 x 1.7 x 1.8")	
Connection size:	M30 x 1.5 mm (1.2" x 0.06")		M30 x 1.5 mm (1.2" x 0.06")	

- Thermdrive is intended for opening or closing valves in heating, cooling or air conditioning systems. It is also suitable for use in a floor heating or ceiling cooling manifolds.
- Available in NO (open without voltage), NC (closed without voltage) and for 230 V and 24 V.
- The internal principle of operation of thermdrive mechanism = its movement so that the valve opens/closes is provided by an electric heating element with expansion material, which expands due to temperature changes in the supply voltage.
- Thermdrive is maintenance-free and works completely silently.
- Thermdrive is fitted with a metal nut M30 x 1.5, thanks to which it becomes a 100% fixed part of the valve with this corresponding thread size after installation.
- The stated nut size predetermines the use of a thermocouple with valves from manufacturers such as Herz, HoneyWell, Danfoss, Oventrop and others.

#### • Telva thermo drive:

- is characterized by absolutely quiet and maintenance-free operation
- is designed for installation - control of heating and cooling systems
- method of mounting the actuator on the controlled valve using an M30 x 1.5 nut
- any working position

#### • Type of use:

- Floor heating – the RFTC-50/G wireless controller measures the room temperature and, based on the set program, sends a command to the RFSA-66M switching element to open/close the TELVA thermo drive on the distributor.

## AN-I | Internal antenna



- into plastic switchboard
- rod angle, without cable
- sensitivity 1 dB
- the internal antenna is included in the standard package

EAN code  
 Internal antenna AN-I: 8595188161862

## AN-E1 | External antenna



- for mounting into metal switchboard
- cable length 3m
- sensitivity 5 dB
- the external antenna AN-E is supplied on request only

EAN code  
 External antenna AN-E: 8595188190121



EAN code			
TC-0:	8595188110075	TZ-0:	8595188110591
TC-3:	8595188110617	TZ-3:	8595188110600
TC-6:	8595188110082	TZ-6:	8595188110594
TC-12:	8595188110099	TZ-12:	8595188110587
		Pt100-3:	8595188136136
		Pt100-6:	8595188136143
		Pt100-12:	8595188136150

Technical parameters	TC	TZ	Pt100
Range:	-20 to +80 °C	-40°C to +125 °C	-30°C to +200 °C
Scanning element:	NTC 12K	NTC 12K	Pt100
Tolerance:	±(0.15 °C + 0.002[t])	±(0.15 °C + 0.002[t])	±(0.3 °C + 0.005[t])
In air/in water:	(τ0.5) ≤ 18 s	(τ65) 62 s/8 s	(τ0.5) -/7 s
In air/in water:	(τ0.9) ≤ 48 s	(τ95) 216 s/23 s	(τ0.9) -/19 s
Cable material:	PVC unshielded, 2 x 0.25 mm <sup>2</sup>	PVC	shielded silicone 2 x 0.22 mm <sup>2</sup>
Terminal material:	polyamid	stainless steel	copper
Protection degree:	IP67	IP67	IP67
Electrical strength:	2500 VAC	2500 VAC	2500 VAC
Insulation resistance:	> 200 MΩ at 500 VDC	> 200 MΩ at 500 VDC	> 200 MΩ at 500 VDC

Types of temperature sensors:

	TC-0	TZ-0	-
- length:	100 mm	110 mm	-
- weight:	5 g	4.5 g	-
	TC-3	TZ-3	Pt100-3
- length:	3 m	3	3 m
- weight:	70 g	106 g	68 g
	TC-6	TZ-6	Pt100-6
- length:	6 m	6 m	6 m
- weight:	130 g	216 g	149 g
	TC-12	TZ-12	Pt100-12
- length:	12 m	12 m	12 m
- weight:	250 g	418 g	249 g

τ65 (95): time, which sensor needs to heat up on 65 (95) % of ambient temperature of environment, in which is located.

- Thermister temperature sensors are made of Negative Temperature Coefficient (NTC) embedded in a PVC or metal sleeve with a thermally-conductive sealer.
- **Sensor TC**
  - lead-in cable to sensor TC is made of wire CYSY 2D x 0.5 mm/0.02".
- **Sensor TZ**
  - cable VO3SS-F 2D x 0.5 mm/0.02" with silicone insulation for use in high temperature applications.
  - silicone insulation for use in high temperature applications.
- **Sensor Pt100**
  - shielded silicon 2x 0.22 mm<sup>2</sup> (AWG 21), shielding connected with a case.
- temperature sensors can be connected directly to the terminal block
- cable lengths can not be changed, connected or modified.

Resistive values of sensors in dependance on temperature

Temperature (°C)	Sensor NTC (kΩ)	Sensor Pt100 (Ω)
20	14.7	107.8
30	9.8	111.7
40	6.6	115.5
50	4.6	119.4
60	3.2	123.2
70	2.3	127.1

Tolerance of sensor NTC 12 kΩ is ± 5% by 25 °C/77 °F.  
Long-term resistance stability by sensor Pt100 is 0.05% (10 000 hours).

Diagramm of sensor warm up via air

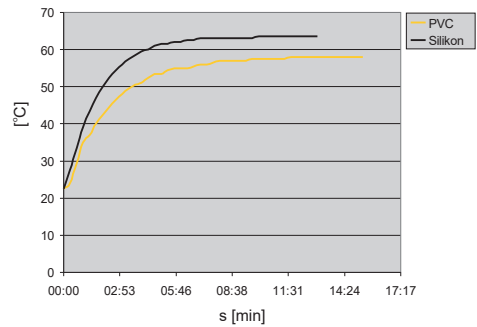

PVC -reaction to water temperature from 22.5 °C to 58°C.  
Silicone - reaction to water temperature from 22.5°C to 63.5°C.

Sensor photo

TC



TZ



Pt100



Drawing

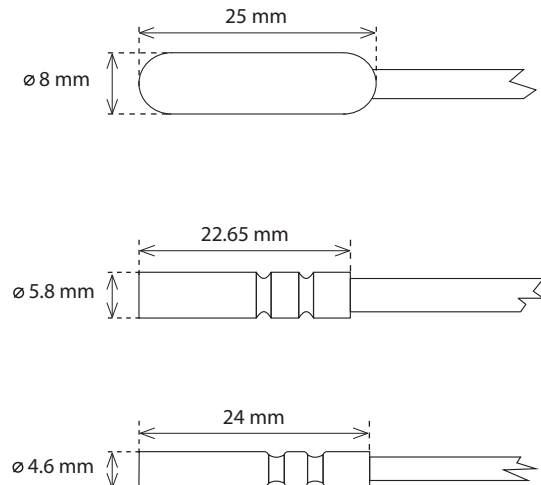

The BUS electro installation iNELS BUS System is a unique solution for electrical installation in the implementation of new projects of houses, villas, apartment buildings, office buildings, hotels, restaurants, wellness centres or perhaps even warehouse or production hall.

The ability to deploy this solution in such a wide variety of different buildings with various purposes and uses lies in its modularity. Thanks to the modular design, the system is very flexible and allows on the one hand, a solution of single-purpose tasks such as control of lighting in restaurants, and on the other hand, solving complex control systems for heating, ventilation, cooling, lighting and shading of office buildings. A complete range of control units designed from glass for management of hotel rooms is in the market unique.

Thanks to its modularity is very easy to customize the size of the system and to that effect create a cost effective solution.

Smart homes and buildings are accompanied by three basic ideas, namely savings, comfort and safety, the first two ideas may at first glance contradict each other. However, the main objective of smart home or building equipped with the iNELS solution is to attain the optimum indoor environment while achieving the most efficient operation of all system.

In homes and buildings the optimal internal environment is very important because people nowadays spend up to 80% of their time inside buildings. It is also shown that indoor environments, where we talk about thermal comfort, lighting comfort and indoor air quality significantly affect the mood and the effectiveness of people.

The iNELS system allows connection of wide range of sensors (temperature, light intensity, carbon dioxide, humidity, and pressure) and detectors (movement, opening doors and windows, gas leakage, smoke, flooding) whose values are constantly evaluated. At the same time iNELS allows the connection of all the technologies that are installed in the building, which continued to significantly increase operational efficiency or comfort, for example; in the case of integrating the guest room management system with the receptionist Fidelio system, which automatically during check-in, sends the room requests for execution, a welcome scene (optimum temperature, comfortable lighting scene, music etc.).

**What are the benefits of BUS controlling?**

- Save energy by regulating lighting and heating properly
- Control of blinds, awnings, exterior or internal window shutters
- Dimming lights, lighting scenes
- control of appliances or electrical devices
- Control access gates, garage doors
- Logical and central functions (exit button, ...)
- Manual and automatic control mode
- Preventing undesirable opening of a window or a door
- Responding to the movement of people (authorized and unauthorized)
- Remote monitoring via smartphone, tablet or laptop
- Possibility to control via the iNELS Touch Panel 10"
- Integration of third-party devices (cameras, air conditioning, ...)



**More systems can be controlled by iNELS:**



Push-button wall controller

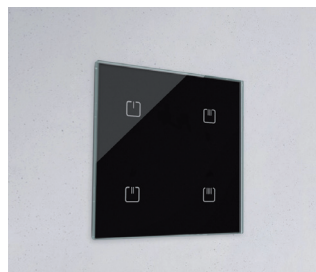

Glass wall controller



Touch panel



Keychain



Remote control

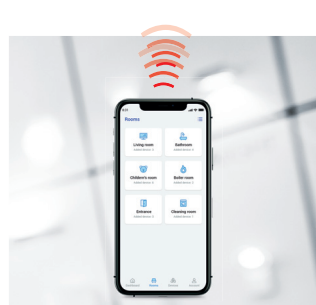

Smartphone



Problematic choice of suitable relay contact for a particular load switched with a product is described below. Mostly we experience problems with incorrect choice of load (meaning incorrect relay for a particular load) which results in permanent switching of contact (sealing) or damage on relay contact – which then results in malfunction. What load can you use? Detailed types of load according to standard EN 60947 are described in charts below – categories of use.

Category of use	Typical use	EN
AC current, $\cos\phi = P/S$ (-)		
AC-1	Non-inductive or slightly inductive load, resistance furnace Includes all appliances supplied by AC current with power factor ( $\cos\phi$ ) $\geq 0.95$ Examples of usage: resistance furnace, industrial loads	60947-4
AC-2	Motors with slip-ring armature, switching off	60947
AC-3	Motors with short-circuit armature, motor switching when in operation This category applies to switching off motors with short-circuit armature while in operation. While switching, contactor switches current which is 5 up to 7 times rated current of motor.	60947-4
AC-4	Electro-motors with short-circuit armature: start up, braking by backset, changeover	60947
AC-5a	Switching of electrical gas-filled lights, fluorescent lights	60947-4
AC-5b	El. bulb switching Enables low contact loading due to resistance of cold fiber is many times smaller than the one of hot fiber.	60947-4
AC-6a	Switching of transformers	60947-4
AC-6b	Switching of capacitors	60947-4
AC-7a	Switching low inductive loads of home appliances and similar applications	60947
AC-7b	Load of motors for home appliances	60947
AC-8a	Switching of hermetically sealed motors of cooling compressors with manual reset switches against overload Hermetically sealed cooling compressors have to be placed in one box without external shaft or shaft padding and motor must operate with cooling liquid	60947
AC-8b	Switching of hermetically sealed motors of cooling compressors with manual reset switches against overload Hermetically sealed cooling compressors have to be placed in one box without external shaft or shaft padding and motor must operate with cooling liquid	60947
AC-12	Switching of semiconductor loads with separation transformers	60947-5
AC-13	Switching of semiconductor loads with separation transformers	60947-5-1
AC-14	Switching of low electro-magnetic loads (max.72 VA)	60947-5-1
AC-15	Management of alternating electro-magnetic loads This category applies to switching inductive loads with input for closed electro-magnetic circuit higher than 72 VA Use: switching coils of contactors	60947-5
AC-20	Connecting and disconnecting in unloaded states	60947-3
AC-21	Switching resistive loads, including low loading	60947-3
AC-22	Switching of mixed resistive and inductive loads, including low overloading	60947-3
AC-23	Switching of motor loads or other high inductive loads	60947-3
AC-53a	Switching of motors with short-circuit armature with semiconductor contactors	60947

Note: Category AC 15 replaces formerly used category AC 11

DC current,  $t = L/R$  (s)

DC-1	Non-inductive or low inductive load, resistive furnaces	60947-4
DC-3	Shunt motors: start-up, braking by backset, reversion, resistive braking	60947-4-1
DC-5	Series motor: start-up, braking by backset, reversion, resistive braking	60947-4-1
DC-6	Non-inductive or low inductive loads, resistive furnaces – el. bulbs	60947-4-1
DC-12	Management of resistive loads and fixed loads with insulation by opto-electric element	60947-5-1
DC-13	Switching of electromagnets	60947-5-1
DC-14	Switching of electromagnetic loads in circuits with limiting resistor	60947-5-1
DC-20a(b)	Switching and breaking without load(a: frequent switching ,b: occasional switching)	60947-3
DC-21a(b)	Switching ohmic loads including limiting overloading (a: frequent switching ,b: occasional switching)	60947-3
DC-22a(b)	Switching of compound ohmic and inductive loads including limited overloads (e.g. shunt motors) (a: frequent switching, b: random switching)	60947-3
DC-23	Switching of highly inductive loads (e.g. series motors)	60947-3

How can you distinguish for which load is our product (relay) designated?

Our company records this information on a products and also in our catalogue, instruction manual and other promotional and technical material (website etc.).



















It is important to realize that it is not always possible to point out load because of lack of information about the device (user cannot measure  $\cos\phi$ ) or it is not possible because of inconsistency of parameters of switched device. Manufacturer of relays records always guaranteed parameters in ideal conditions which are done by a norm (temperature, pressure, humidity, etc.) and reality can be in a lot of cases different. Category of use (classification) of a particular relay is done by material of output contacts.

Basic types of materials which are used for production of contacts for high-performance relay are:



















- AgCd – suitable for switching ohmic loads. Before of harmfulness of Cd, this type of contact is remitted.
- AgNi – designated for switching resistive loads, good quality switching and conducting (contact doesn't oxidate) small currents/voltages, it is not designated for surge currents and loads with inductive component.
- AgSn or AgSnO<sub>2</sub> – suitable for switching loads with inductive component, not suitable for switching small currents/voltages, it is more resistive to surge currents, suitable for DC voltage switching, less suitable for switching loads of ohmic type.
- Wf (wolfram)-special contact designated for switching surge currents with inductive component.
- with gold (AgNi/Au)- Used for "improving" contacts for low currents/ voltages , prevents oxidation.

Minimum load			Minimum load		
Relay contact	mV	V/mA	Relay contact	mV	V/mA
AgSnO <sub>2</sub>	1000	10/100	AgNi	300	5/10



















## GCR3-11, GCH3-31, GMR3-61, SA3-02B, SA3-06M, SA3-012M, WMR3-21

Type of load	 $\cos \varphi \geq 0.95$					 HAL 230V			
Contact material	AC1	AC2	AC3	AC5a uncompensated	AC5a compensated	AC5b	AC6a	AC7b	AC12
AgSnO <sub>2</sub> contact 8 A	250 V/8 A	250 V/2.5 A	250 V/1.5 A	230 V/1.5 A (345 VA)	230 V/1.5 A (345 VA) till max output C=14uF	250 W	250 V/4 A	250 V/1 A	250 V/1 A
Type of load									
Contact material	AC13	AC14	AC15	DC1	DC3	DC5	DC12	DC13	DC14
AgSnO <sub>2</sub> contact 8 A	x	250 V/3 A	250 V/3 A	24 V/8 A	24 V/3 A	24 V/2 A	24 V/8 A	24 V/1 A	x



















## LBC3-02M, SA3-04M, SA3-022M (RE7 - RE-10), JA3-018M (U/D1 - U/D9)

Type of load	 $\cos \varphi \geq 0.95$					 HAL 230V			
Contact material	AC1	AC2	AC3	AC5a uncompensated	AC5a compensated	AC5b	AC6a	AC7b	AC12
AgSnO <sub>2</sub> contact 16 A	250 V/16 A	250 V/5 A	250 V/3 A	230 V/3 A (690 VA)	230 V/3 A (690 VA) till max output C=14uF	1500 W	x	250 V/3 A	250 V/10 A
Type of load									
Contact material	AC13	AC14	AC15	DC1	DC3	DC5	DC12	DC13	DC14
AgSnO <sub>2</sub> contact 16 A	250 V/6 A	250 V/6 A	250 V/6 A	24 V/16 A	24 V/6 A	24 V/4 A	24 V/16 A	24 V/2 A	24 V/2 A

## SA3-02B/Ni\*, SA3-06M/Ni\*, SA3-012M/Ni\*

Type of load	 $\cos \varphi \geq 0.95$					 HAL 230V			
Contact material	AC1	AC2	AC3	AC5a uncompensated	AC5a compensated	AC5b	AC6a	AC7b	AC12
AgNi contact 8 A	250 V/8 A	250 V/2.5 A	250 V/1.5 A	230 V/1.5 A (345 VA)	x	400 W	x	250 V/1.5 A	250 V/5 A
Type of load									
Contact material	AC13	AC14	AC15	DC1	DC3	DC5	DC12	DC13	DC14
AgNi contact 8 A	250 V/3 A	250 V/3 A	250 V/3 A	24 V/8 A	24 V/3 A	24 V/2 A	24 V/8 A	24 V/1 A	24 V/1 A





## SA3-06M/Ni\*, SA3-04M/Ni\*

Type of load	 $\cos \varphi \geq 0.95$					 HAL 230V			
Contact material	AC1	AC2	AC3	AC5a uncompensated	AC5a compensated	AC5b	AC6a	AC7b	AC12
AgNi contact 16 A	250 V/16 A	250 V/5 A	250 V/3 A	230 V/3 A (690 VA)	x	800 W	x	250 V/3 A	250 V/10 A
Type of load									
Contact material	AC13	AC14	AC15	DC1	DC3	DC5	DC12	DC13	DC14
AgNi contact 16 A	250 V/6 A	250 V/6 A	250 V/6 A	24 V/16 A	24 V/6 A	24 V/4 A	24 V/16 A	24 V/2 A	24 V/2 A

## JA3-018M (U/D1 - U/D9),

## SA3-022M (RE1 - RE6, OUT1 - OUT2, RE11 - RE16, SHUTTER),







## FA3-612M (FAN1 - FAN3, RE)

Type of load	 $\cos \varphi \geq 0.95$			
Contact material	AC1	AC3	AC15	DC1
AgNi contact 6 A	250 V/6 A	230 V/0.8 A	230 V/1.3 A	30 V/3 A 110 V/0.2 A 220 V/0.12 A













Demonstrated symbols are informative.

\*Products with AgNi contact only up on request for extra charge.

## Loadability of contacts

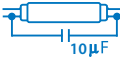
Load	bulbs, halogen bulbs	12–24 V low-voltage bulbs, coil transformers	12–24 V low-voltage bulbs, electric transformers	LEDs	energy-saving fluorescent tubes	control method	
							
	R	L	C	dimmable	dimmable	entering edge	trailing edge
DA3-22M	•	•	•	•	•	•	•
DA3-66M	•	•	•	•	•	•	•

## Explanations

	<b>El. bulbs loads:</b> el. bulb, halogen light (R)		Elektronic ballasts for fluorescent (L)
	<b>Dimmer with defined load:</b> R - resistive, L - inductive, C - capacitive		<b>Inductive loads (transformers):</b> feromagnetic and toroid transformers for lights with various voltage.
	<b>Fluorescent light:</b> fluorescent lights uncompensated		<b>Switch:</b> switch - control contact of various device
	<b>Fluorescent light:</b> fluorescent light compensated in series		<b>Button:</b> control button
	<b>Fluorescent light:</b> fluorescent light compensated in parallel		<b>Control module:</b> analog control module 0 - 10 V
	<b>Fluorescent light:</b> fluorescent light economical		Motor

## Category of use

## Typical use

AC current,  $\cos\varphi = P/S$  (-)

AC-1	Non-inductive or slightly inductive load, resistance furnace. Includes all appliances supplied by AC current with power factor ( $\cos\varphi$ ) $\geq 0.95$ . Examples of usage: resistance furnace, industrial loads.
AC-2	Motors with slip-ring armature, switching off.
AC-3	Motors with short-circuit armature, motor switching when in operation. This category applies to switching off motors with short-circuit armature while in operation. While switching, contactor switches current, which is 5 up to 7 times rated current of motor.
AC-5a	Switching of electrical gas-filled lights, fluorescent lights.
AC-5b	El. bulb switching. Enables low contact loading due to resistance of cold filament is many times smaller than the one of hot filament.
AC-6a	Switching of transformers.
AC-7b	Load of motors for home appliances.
AC-12	Switching of semiconductor loads with separation transformers.
AC-13	Switching of semiconductor loads with separation transformers.
AC-14	Switching of low electro-magnetic loads (max. 72 VA).
AC-15	Management of alternating electro-magnetic loads. This category applies to switching inductive loads with input for closed electro-magnetic circuit higher than 72 VA. Use: switching coils of contactors.

Note: Category AC 15 replaces formerly used category AC 11.

DC current,  $t = L/R$  (s)

DC-1	Non-inductive or low inductive load, resistive furnaces.
DC-3	Shunt motors: start-up, braking by backset, reversion, resistive braking.
DC-5	Series motor: start-up, braking by backset, reversion, resistive braking.
DC-12	Management of resistive loads and fixed loads with insulation by opto-electric element.
DC-13	Switching of electromagnets.
DC-14	Switching of electromagnetic loads in circuits with limiting resistor.



### 1) Surface mounted

Wall mounted in an installation box with spacing of 65 mm.

EST3	GSB3-40/S
EHT3	GSB3-60/S
GBP3-60x	GSP3-100
GCR3-11	GMR3-61
GCH3-31	IDRT3-1
GRT3-50	WMR3-21
GSB3-40	WSB3-20
GSB3-60	WSB3-20H
GSB3-80	WSB3-40
GSB3-20/S	WSB3-40H

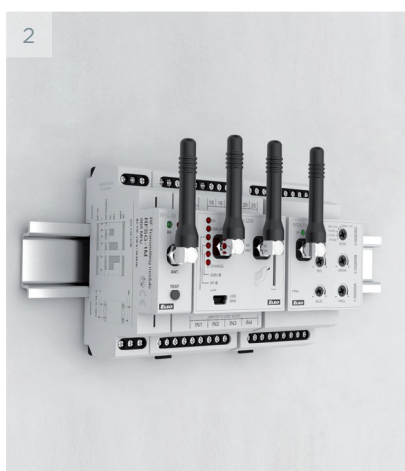

### 2) DIN Rail mounted

On DIN rail according to EN 60715.

ADC3-60M	JA3-018M
CU3-07M	LBC3-02M
DA3-66M	PS3-30/iNELS
DA3-22M	PS3-100/iNELS
DAC3-04M	SA3-04M
DCDA-33M	SA3-06M
EMDC-64M	SA3-012M
FA3-612M	SA3-022M
IM3-140M	TI3-60M
IOU3-108M	

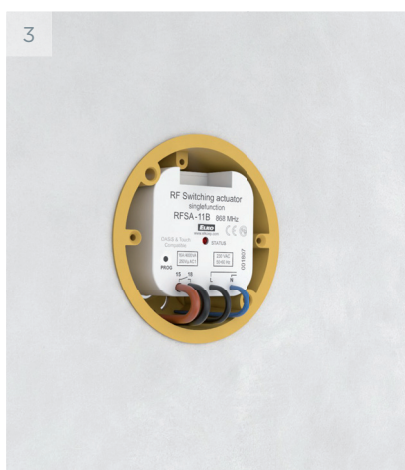

### 4) Mounted to or in the installation box

Mounted in an installation box or built into the device.

IM3-40B	SA3-01B
IM3-80B	SA3-02B
JA3-02B/DC	TI3-40B



### 4) Mounted into the cover of appliance

SA3-01B  
SA3-02B

5



**5) Surface mounted**

*Other attachment options.*

DLS3-1

6



**6) Ceiling mounting**

DMD3-1

1-MODULE

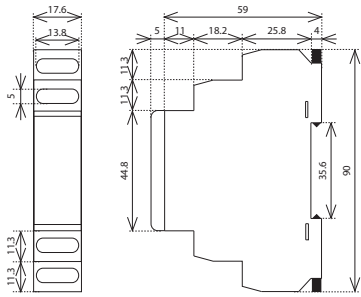

CU3-07M

3-MODULE

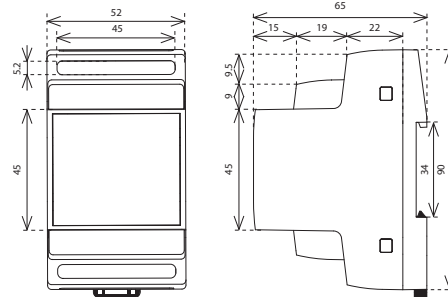

- ADC3-60M
- DA3-22M
- DAC3-04M
- DCDA-33M
- EMDC-64M
- IM3-140M
- LBC3-02M

- PS3-30/iNELS
- SA3-04M
- SA3-06M
- TI3-60M
- RFDA-73M/RGB

6-MODULE

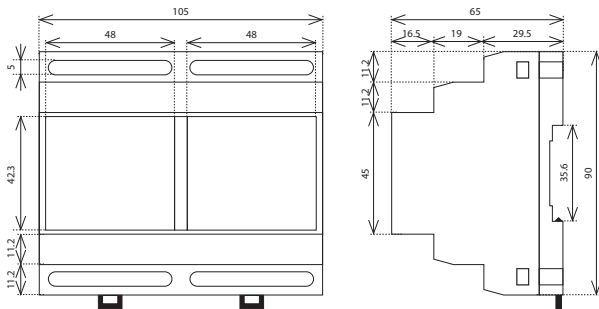

- DA3-66M
- FA3-612M
- IOU3-108M
- JA3-018M
- PS3-100/iNELS
- SA3-012M
- SA3-022M

BOX

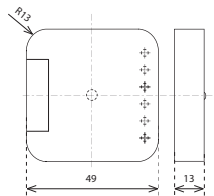

IM3-40B  
JA3-02B/DC

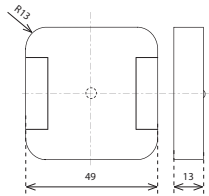

DAC3-04B  
IM3-80B  
TI3-40B

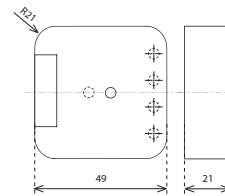

SA3-01B  
SA3-02B

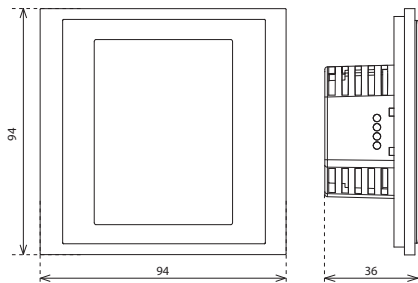

EST3-1  
EHT3-1

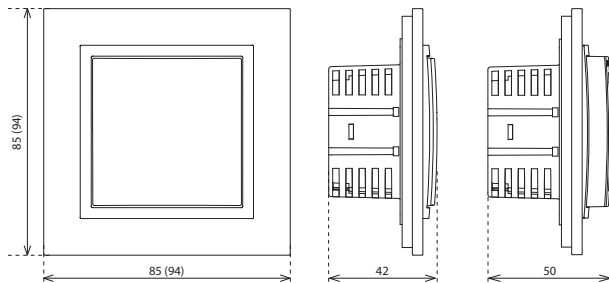

WSB3-20  
WSB3-20H  
WSB3-40  
WSB3-40H  
WMR3-21

IDRT3-1

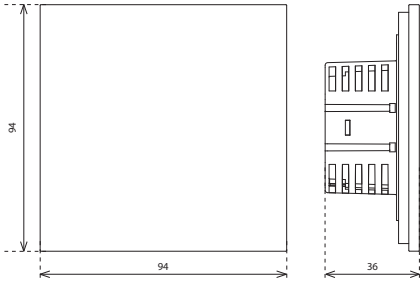

- GCR3-11
- GDB3-10
- GMR3-61
- GRT3-50
- GSB3-40
- GSB3-60
- GSB3-80
- GSB3-20/S
- GSB3-40/S
- GSB3-60/S

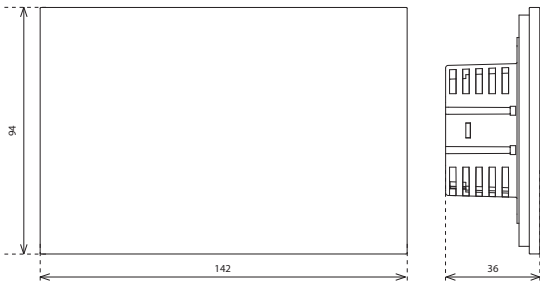

- GSP3-100
- GCH3-31

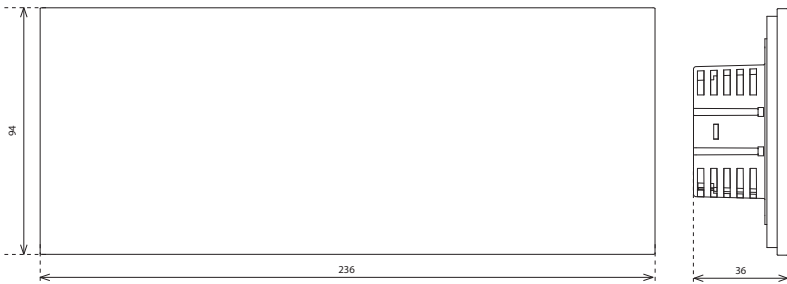

- GBP3-60x/2F

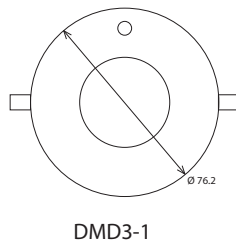
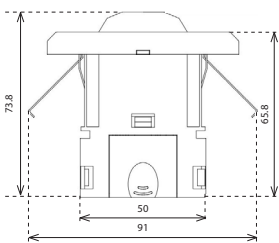

DMD3-1

IP65

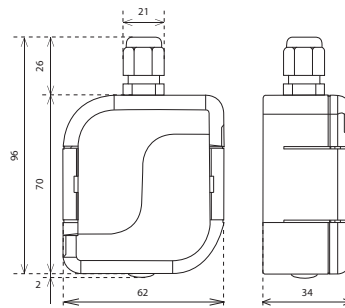

DLS3-1



## ● Headquarters

ELKO EP Holding SE, Czech

## ● Branches

ELKO EP Germany, GmbH, Germany

ELKO EP Hungary Kft., Hungary

ELKO EP Poland, sp. z.o.o., Poland

ELKO EP RUS LLC, Russia

ELKO EP UKRAINE LLC, Ukraine

ELKO EP UK, United Kingdom

ELKO EP Serbia, Serbia

ELKO EP SLOVAKIA, s. r. o., Slovakia

## ○ Franchises

ELKO EP Bulgaria, Bulgaria

ELKO EP Kuwait, Kuwait

ELKO EP Saudi Arabia, Saudi Arabia

ELKO EP España, S.L., Spain

iNELS BALTIC

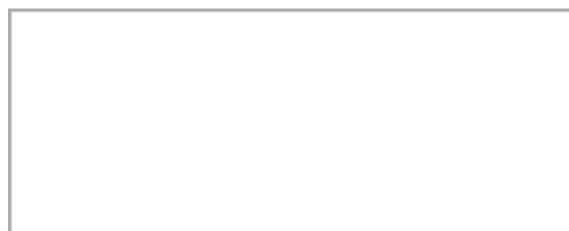

**ELKO EP, s.r.o.** | Palackeho 493 | 769 01 Holesov, Vsetuly | Czech Republic

phone: +420 573 514 221 | fax: +420 573 514 227 | [elko@elkoep.com](mailto:elko@elkoep.com) | [www.elkoep.com](http://www.elkoep.com)

Published: 01/2022 | Modifications or amendments reserved | © Copyright ELKO EP, s.r.o. | 1<sup>st</sup> edition