

# SWITCHES AND SOCKETS

LOGUS<sup>90</sup>

TECHNICAL CATALOGUE

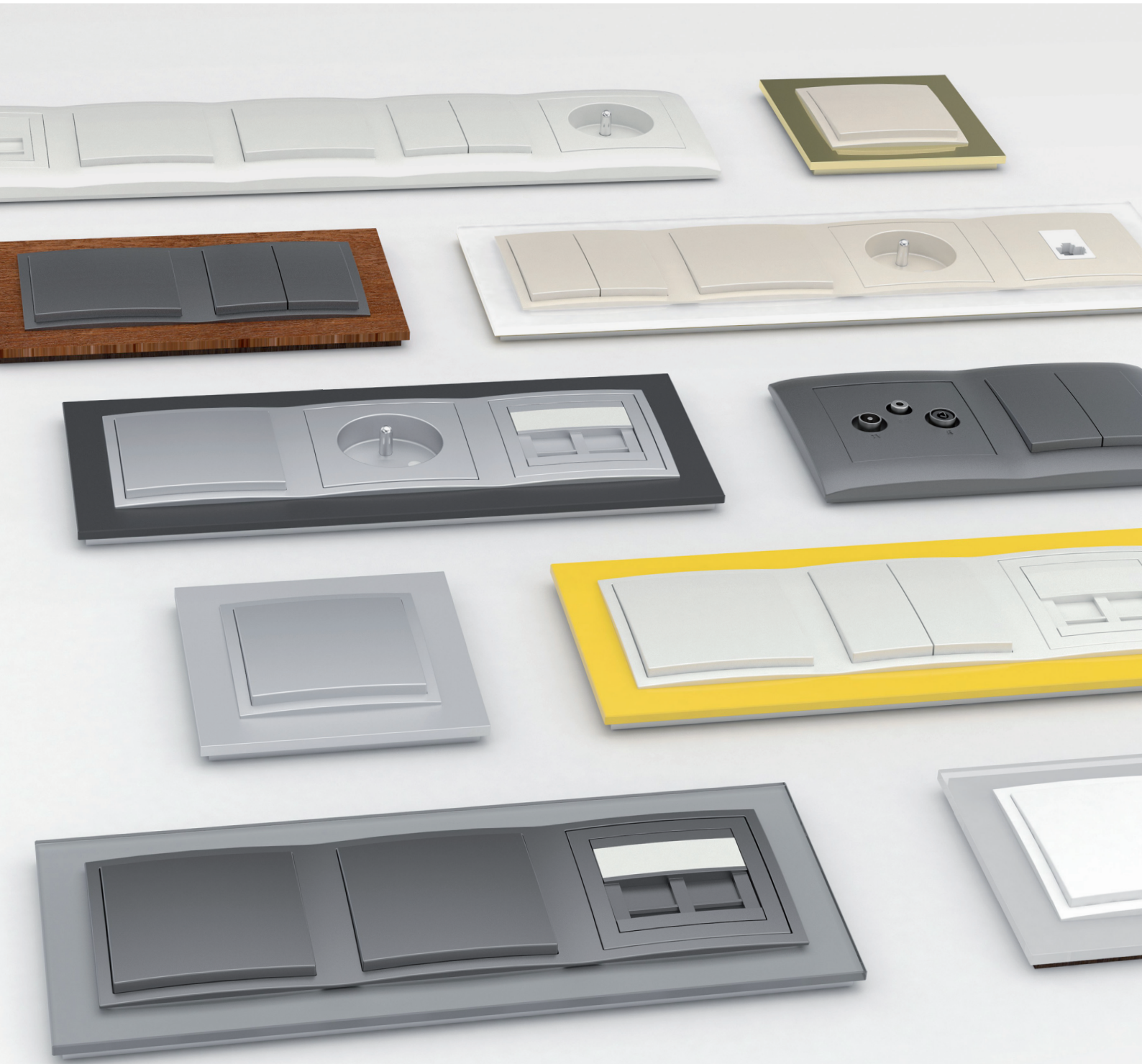

# ELKO EP



**We are traditional, innovative and purely Czech development manufacturer of electronic devices and we have been your partner in the field of electroinstallations for 26 years.**

ELKO EP employs about 330 people, exports its products to more than seventy countries, and has representatives in thirteen foreign branches. Company of the Year of the Zlín Region, Visionary of the Year, Global Exporter of the Year, Participation in the Czech TOP 100, these are just some of the awards received. Still, we are not finished. We are constantly striving to move forward in the field of innovation and development. That's our primary concern.

Millions of relays, thousands of satisfied customers, hundreds of our own employees, twenty six years of research, development and production, thirteen foreign branches, one company. ELKO EP, innovative- a purely Czech company based in Holešov, where development, production, logistics, service and support go hand in hand. We primarily focus on developing and manufacturing systems for building automation in the residential, commercial and industrial sector, a wide range of Smart city facilities and the so-called Internet of Things (IoT).



# Facts and stats

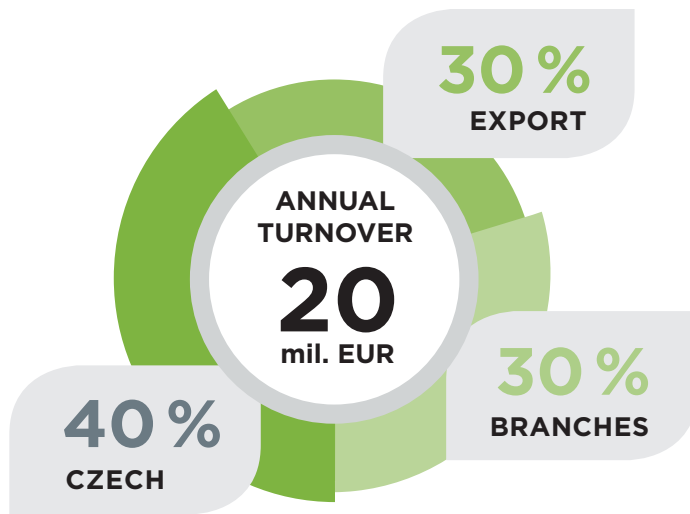

## WE ARE



### DEVELOPERS

In the new R&D center, more than 30 engineers develop new products and extend the functionality of existing products



### PRODUCERS

modern antistatic spaces, 2x fully automated SMD production lines, 2 shift operations.



### SUPPORT

24 hours / 7 days / 360 days we not only provide technical support but also logistics.



### SELLERS

personal access to more than 70 sales representatives in ELKO EP Holding provides impeccable services and superior products at an affordable price.





#### Timers/Relays

[www.elkoep.com/relay-modular-electronic-devices](http://www.elkoep.com/relay-modular-electronic-devices)

A wide range of electronic modular devices, which bring new possibilities to home and office control, monitoring and security, as well as to industrial process control: time relays, installation contactors, staircase automatic switches, time switches clocks, dimmers, thermostats, power supplies units, control and signalling devices, GSM gates, etc.



#### Protection relays for industry

[www.elkoep.com/protection-monitor-relay](http://www.elkoep.com/protection-monitor-relay)

Every household, every object and every machine needs a monitoring relay. There are several reasons why, overvoltage, under voltage, phase failure, asymmetry, frequency, or power factor.



#### iNELS Air – IoT devices

[www.elkoep.com/iot-products](http://www.elkoep.com/iot-products)

The new iNELS Air product line responds to the dynamically developing network IoT (Internet of Things). These networks enable devices to communicate safely, over long distances and are optimized to minimize power consumption. The product group includes sensors for communication on the Sigfox, LoRa and NB-IoT protocol.



#### Wireless electroinstallation (RF)

[www.elkoep.com/wireless-rf-control](http://www.elkoep.com/wireless-rf-control)

A unique wireless control system providing you perfect control over your home! The RF Control system enables you to control functions such as heating, lighting, electrical appliances and window shutters, all with a single touch. No wall cutting, fast and easy installation, exclusive design of wireless wall switch buttons and other components.



#### Wired electroinstallation (BUS)

[www.elkoep.com/inels-bus-system](http://www.elkoep.com/inels-bus-system)

The BUS system offers a unique solution for new installations (refurbishment) in family houses, hotels and villas. It offers a wide range of functions for both automation and comfort.



#### Energy management

[www.elkoep.com/energy-management](http://www.elkoep.com/energy-management)

Measuring energy consumption in the home or in larger areas is an increasing trend. Our products provide measurement with three different technologies – using a BUS or wireless and with the IoT.



#### Wireless Retrofit Hotel (HRESK)

[www.elkoep.com/hotel-hresk](http://www.elkoep.com/hotel-hresk)

Hotel Room Energy Saving Kit - Solutions for hotel rooms based on wireless technology is designed to function in existing hotels. It is possible to simply elevate the existing electrical installation to a higher level without long-lasting construction modifications.



#### Hospitality Hotel (GRMS)

[www.elkoep.com/inels-hospitality](http://www.elkoep.com/inels-hospitality)

Guest Room Management System – The BUS system is designed mainly for hotels and offers comfortable and easy control of hotel rooms, reception and restaurant.



#### Building management system

[www.elkoep.com/bms](http://www.elkoep.com/bms)

Building Management System is a comprehensive solution for monitoring, and controlling even the most complex of building systems. You can monitor everything on your computer monitor or tablet in the comfort of reception or office.



#### Lighting control

[www.elkoep.com/lighting-control](http://www.elkoep.com/lighting-control)

A sector that offers complete control over all lighting devices. From switching, dimming to controlling your favourite DALI luminaires. Everything can be controlled with a connection to iNELS wired or wireless technology.



#### Multimedia

[www.elkoep.com/av-multimedia](http://www.elkoep.com/av-multimedia)

Here you can find extensions for our iNELS system and not just for it. Lara Music Players, Intercoms and Door Communicators, Application Communication Servers and 3rd party applications.



#### Switches and sockets

[www.elkoep.com/logus90-products](http://www.elkoep.com/logus90-products)

We offer you exclusive switches, sockets and accessories in a standard plastic or metallic design. However, there are also charming luxury frames from purely natural materials such as genuine wood, metal, granite or tempered glass. Be special!

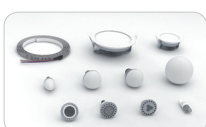

#### Lighting sources

[www.elkoep.com/lighting-sources](http://www.elkoep.com/lighting-sources)

Are you looking for a bulb for your chandelier? In this section you will find among the most common types of bulbs also LED strips and other LED sources, power transformers and installation accessories such as ALU profiles, diffusers.





As when we painted our future housing on paper with crayons when we were young, the LARA configurator allows us to indulge in this hobby to this day. Do you like timeless design of frames made of natural materials? Would you like glass switches and controls? Do not you know if they'll be in tune with the colour of your walls? Will they fit comfortably into a given area?

 [lara.inels.com](http://lara.inels.com)



Try the LARA configurator online. You can choose from one single frame to five frames. Combine the features that will keep you entertained!



Just 4 steps in the configurator:

At each step of the configurator, you choose, for example, the installation method, the size or design of the frame (e.g. glass, wood, metal), the wall colour/type and the type of speakers (wall, ceiling, ...). The result delivers an overview and estimated total cost. You can place the order here directly or send it by email.

### 1. LARA device type



### 2. Installation type

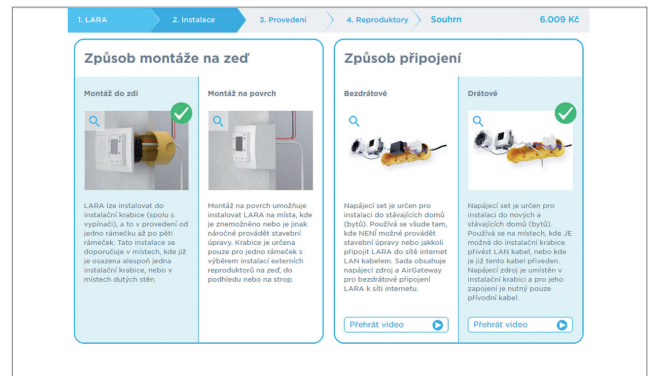

### 3. Design selection

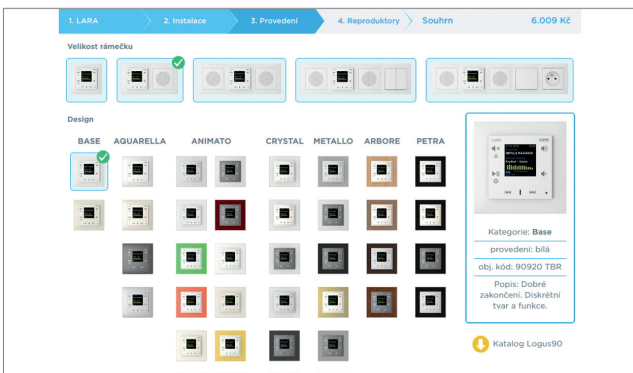

### 4. Select speakers



<b>Basic information</b> .....	8
- Design lines LOGUS <sup>90</sup>	
- Benefits of the MEC 21 Series Mechanisms	
- Ordering example	
<b>Control devices and Rockers / Cover plates</b> .....	12
- Switch	
- Pull-cord Push-button	
- Key Lock Push-button	
- Rocker Push-button	
- Rotary Switch	
- Dimmers	
- Push-button	
- Button	
- Blind push-button switch	
- Circuits Digital Time Switch	
- Motion Detector	
- Temperature Control	
<b>Sockets and Cover plates</b> .....	19
- Energy sockets	
- Schuko, EURO - USA	
- Data sockets	
- RJ45 connectors	
- Radio, television and satellite sockets	
- Multimedia socket, USB	
- Telephone socket	
<b>Accessories</b> .....	24
- Accessories	
- Accessory for controlling blinds	
<b>Other</b> .....	25
- Semi-assembled (cover plate + frame)	
- Complete devices (mechanism + cover plate + frame)	

<b>Frames, Back plate covers with Frame</b> .....	26
- BASE	
- AQUARELLA	
- ANIMATO	
- CRYSTAL	
- METALLO	
- ARBORE	
- PETRA	
- Frames - Dimensions	
<b>Technical data</b> .....	32
- Wiring Diagram	
- Technical Data	
<b>Jazz Light series</b> .....	44
- Loudspeakers	
- Sound control units	
- Modular Sound Central Units	
- Power supplies	
- Accessories	
<b>Waterproof 48 series</b> .....	49
- Switches and sockets with IP65 protection	
<b>LARA</b> .....	53
- LARA Radio, LARA Intercom	
- Intercom & Videophone	
- Installation	
- Accessories	



# LOGUS<sup>90</sup>

## BASE

Smart finish. Discrete shape of function.

Dimensions: 85.6 x 85.6 mm



BR - White



MF - Ivory

## AQUARELLA

Distinct colors. Shades that characterize the space.

Dimensions: 85.6 x 85.6 mm

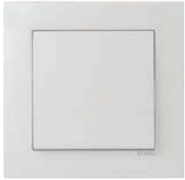

GE - Ice



PE - Pearl



AL - Aluminium



IS - Gray

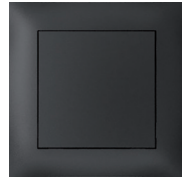

PM - Black

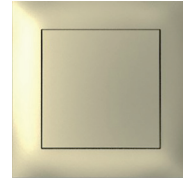

DU - Gold

## ANIMATO

Large selection of colors, modern design and pleasant price.

Dimensions: 94 x 94 mm



BB - White/White



MM - Ivory/  
Ivory



EE - Ice/Ice



PP - Pearl/Pearl



RG - Yellow/Ice



DG - Green/Ice



ZG - Blue/Ice



JG - Orange/Ice



VG - Red/Ice



TS - Brick/Gray



BS - Wine/Gray



AA - Aluminium/  
Aluminium



AS - Aluminium/Gray



SS - Gray/Gray



PG - Black/Ice



PA - Black/Aluminium

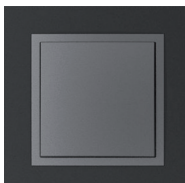

PS - Black/Gray



RR - Black/Black



UG - Gold/Ice



UU - Gold/Gold

**CRYSTAL**

Brightness and clarity. Shades that bring the shine of crystals into a honed experience.

Dimensions: 94 x 94 mm



CG - Cristal/Ice    CP - Cristal/Pearl    CA - Cristal/Aluminium    CS - Cristal/Gray

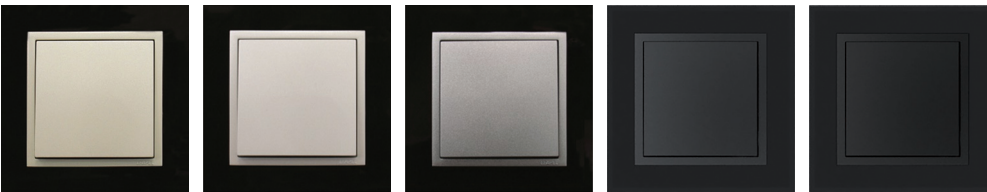

EC - Glass - black/Pearl    EG - Glass - black/Ice    EA - Glass - black/Aluminium    ES - Glass - black/Gray    EP - Glass - black/Black

**METALLO**

Distinct and modern feel. The refinement and brightness of metal enhance the value of the surroundings, and lend inspiration to great moments.

Dimensions: 94 x 94 mm



TP - Titanium/Pearl    IA - Inox/Aluminium    OP - Gold/Pearl    QS - Nickel/Gray    US - Aluminium/Gray    RS - Chrome/Gray    OU - Gold/Gold

**ARBORE**

Selection of natural materials. Warm shades of wood with their varying structures create a room full of happiness and sincere comfort.

Dimensions: 94 x 94 mm



FP - Beech Wood/Pearl    JP - Cherry Tree /Pearl    MS - Mahogany/Gray    NA - Walnut Tree/Aluminium

**PETRA**

Selection of natural materials. Warm shades of wood with their varying structures create a room full of happiness and sincere comfort.

Dimensions: 94 x 94 mm



GG - Granite/Ice    GP - Granite/Pearl    GA - Granite/Aluminium    GS - Granite/Gray

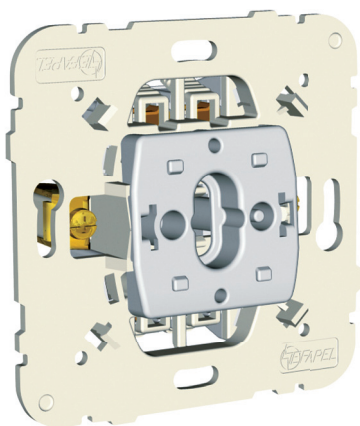

The MEC21 Series Mechanisms for the LOGUS<sup>90</sup> Design Series are made of a special alloy of non-combustible plastics that, due to their strength and elasticity, prevent destruction or damage to the body. The plastic design of the mechanism also ensures secure isolation from the conductive parts of the installation.

The mounting frame is an integral part of the device. The whole device is compact, lightweight and allows for easy and quick assembly without the use of tools.

With the "smart clips" on the front of the device, the frame and cover can be easily snapped on and off. It can be easily and quickly changed and adapted to the current colours of the walls of your interior.

10A - 250V~ - Screwless connection

16A / 20A - 250V~ - Connection with screw terminals

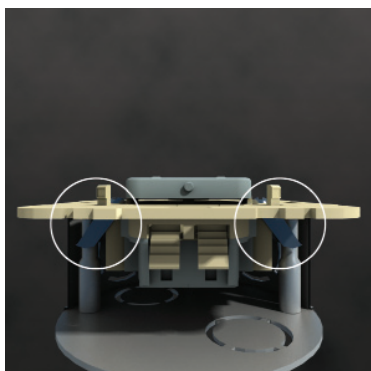

Quick Clips allow installation to adjust the frame on an uneven wall (two positions for the "snap" frame). Inequality walls will allow the deal and Floating Fingerboard.

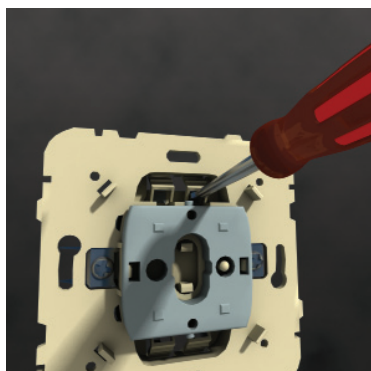

Ability to test electrical functionality of your device without disassembly.

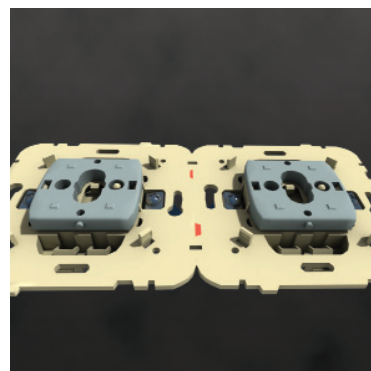

Shaped edge of the body mechanism to align the mounting multiple devices.



Depth 20 mm only allows mounting to instrumentation device / box.

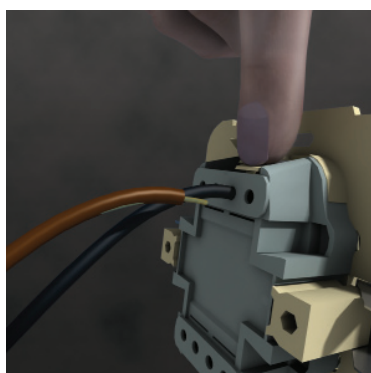

Screwless terminals provide fast and quality connection without need of instrument usage. Double terminals on every pole provide multiple connection without need of extra terminals usage.



Ability to test electrical functionality of your device without disassembly.



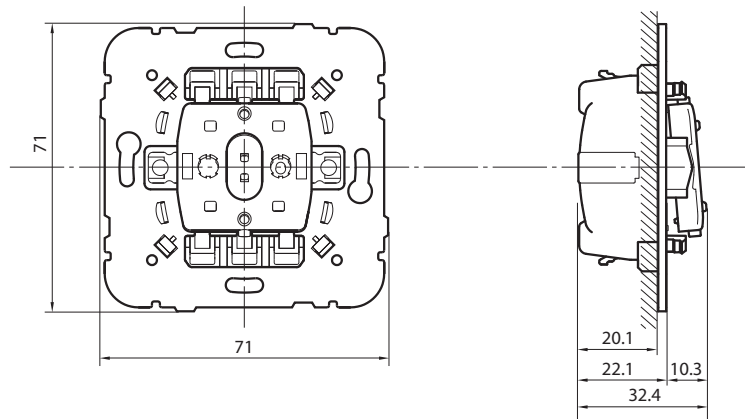

Order example

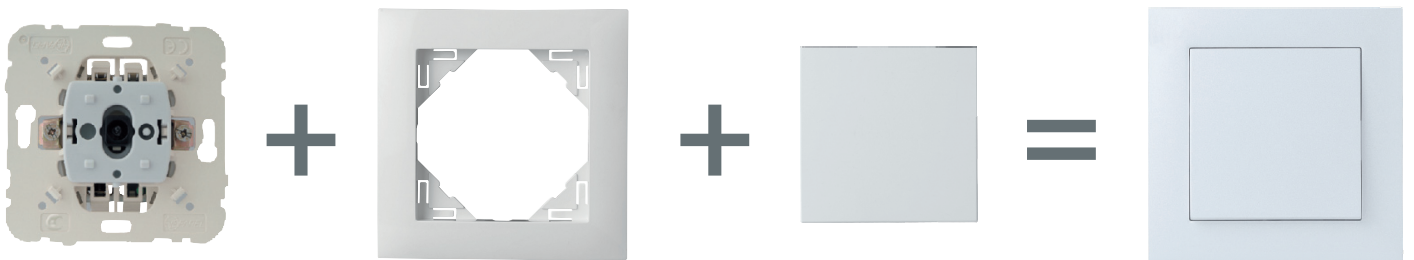

**MECHANISM MEC21**

oder code: 21 ...  
 e.g.:  
 21011 = Single Pole Switch  
 21111 = Earth Socket

**FRAME**

oder code: 909 ... T x x  
 e.g.:  
 90910 TBR = Single Frame, plastic/white  
 90930 TCS = Triple Frame, cristal/gray

**ROCKER / COVER PLATE**

oder code: 90 ... T x x  
 e.g.:  
 90601 TBR = kRocker for Switches, white  
 90652 TAL = Safety Cover Plate for Earth Socke, aluminium

**COMPLETE PRODUCT**

oder code: ...  
 e.g.:  
 21011, 90910 TBR, 90601 TBR  
 Mechanism, Frame, Rocker /  
 Cover Plate

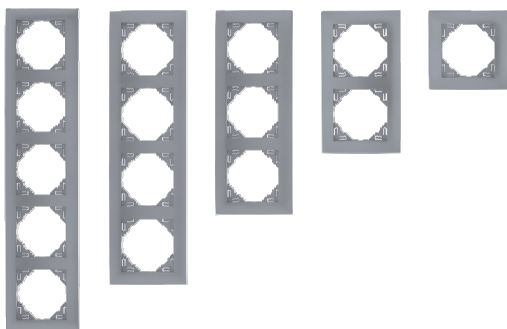









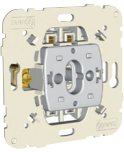





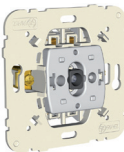

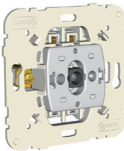

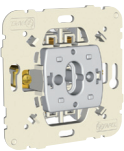

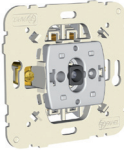

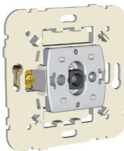

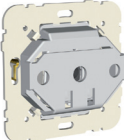



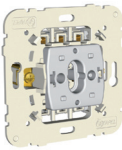

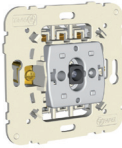

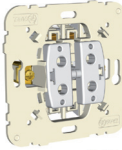
The entire design series are available from 1 frame up to 4 frames.

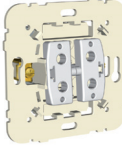
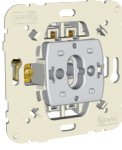
The BASE and AQUARELLA series are available from 1 frame up to 5 frames.

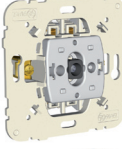
Horizontal or vertical position of the frame is possible thanks to their symmetrical shape.

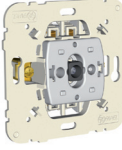
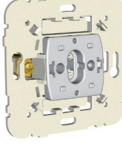









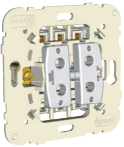

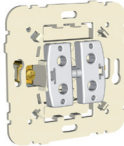
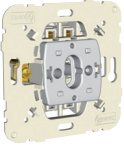

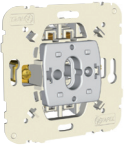

Device covers in red, orange, green for hospital environments.

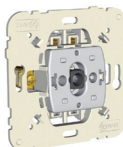
Control devices			Rockers / Cover plates					
		Order code	Box (Un)			Order code	Color	Box (Un)
	Single Pole Switch 10AX - 250V~	21011	10		Rocker for Switches	90601 T	BR MF GE PE AL IS PM DU	20 2
	Three Circuits Switch 16AX - 250V~	21088	10		Triple Rockers	90661 T	BR MF GE PE AL IS PM DU	20 2
	Electronic Very Low Tension 4-Gang Push-button 12V - 50mA / 32V - 18mA	21164	10		Quadruple Rocker	90600 T	BR MF GE PE AL IS PM DU	2
	Single Pole Switch with Orienting Light 10AX - 250V~	21012	10		Rocker for Lighted Switches	90602 T	BR MF GE PE AL IS PM DU	20 2
	Single Pole Switch with Pilot Lamp 10AX - 250V~	21013	10		Rocker for Lighted Switches / Push-button with Lamp Symbol	90797 T	BR MF GE PE AL IS PM DU	20
	Two-pole Switch 10AX - 250V~	21021	10		Rocker for Switches	90601 T	BR MF GE PE AL IS PM DU	20 2
					Rocker for Two-pole Switch	90608 T	BR MF GE PE AL IS PM DU	2
	Two-pole Switch with Pilot Lamp 10AX - 250V~	21023	10		Rocker for Lighted Switches	90602 T	BR MF GE PE AL IS PM DU	20 2
	Two-pole Switch with Pilot Lamp - 20A 20A - 250V~	21024	10		Rocker for Lighted Switches / Push-button with Lamp Symbol	90797 T	BR MF GE PE AL IS PM DU	20 2
	Card-system Switch 10AX - 250V~ - For ATM card type (Ref. 21999).	21031	10		Cover Plate for Card-system Switch	90731 T	BR MF GE PE AL IS PM DU	2

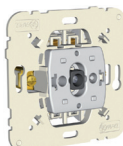

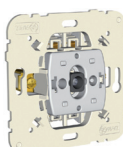







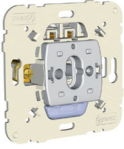

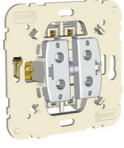
Control devices		Order code	Box (Un)	Rockers / Cover plates		Order code	Color	Box (Un)
	Intermediate Switch 10AX - 250V~	21051	10		Rocker for Switches	90601 T	BR MF GE PE AL IS PM DU	20 2
	Intermediate Switch with Orienting Light 10AX - 250V~	21052	10		Rocker for Lighted Switches	90602 T	BR MF GE PE AL IS PM DU	20 2
	Two Circuits Switch 10AX - 250V~	21061	10		Double Rockers	90611 T	BR MF GE PE AL IS PM DU	20 2
	Two circuit switch 5 20 A - 250 V	21065	10					
	Two-way Switch 10AX - 250V~	21071	10		Rocker for Switches	90601 T	BR MF GE PE AL IS PM DU	20 2
	Two-way Switch with Orienting Light 10AX - 250V~	21072	10		Rocker for Lighted Switches	90602 T	BR MF GE PE AL IS PM DU	20 2
	Two-way Switch with Pilot Lamp 10AX - 250V~	21073	10					
	Two-way Switch - 20A 20A - 250V~	21075	10		Rocker for Switches	90601 T	BR MF GE PE AL IS PM DU	20 2
	Pull-cord Push-button 10A - 250V~	21091	10		Cover Plate for Pull-cord Push-button / Two-way Switch	90741 T	BR MF GE PE AL IS PM DU	2
	Pull-cord Two-way Switch 10AX - 250V~	21092	10					

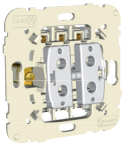
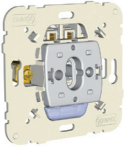
Legend: T - Rocker, Cover Plate or Frame. BR - White, MF - Ivory, GE - Ice , PE - Pearl, AL - Aluminium, IS - Gray, PM - Black, DU - Gold.  
Wiring diagrams can be found on pages 32 to 43.

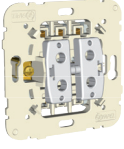

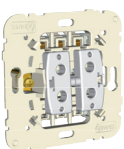
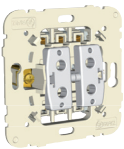

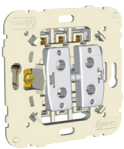

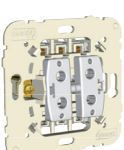

Control devices			Rockers / Cover plates					
		Order code	Box (Un)		Order code	Color	Box (Un)	
	Double Two-way Switch 10AX - 250V~	21101	10		Double Rockers	90611 T	BR MF GE PE AL IS PM DU	20 2
	Double Two-way Switch - 20A 20A - 250V~	21103	10					
	Rocker Push-button (NO+NC) 10A - 250V~	21150	10		Rocker for Switches	90601 T	BR MF GE PE AL IS PM DU	20 2
	Rocker Push-button 10A - 250V~	21151	10		Rocker for Switches with Lock Symbol	90604 T	BR MF GE PE AL IS PM DU	2
					Rocker for Switches with Bell Symbol	90605 T	BR MF GE PE AL IS PM DU	2
					Rocker for Switches with Maid Symbol	90606 T	BR MF GE PE AL IS PM DU	2
					Rocker for Switches with Lamp Symbol	90607 T	BR MF GE PE AL IS PM DU	2
	Rocker Push-button with Orienting Light - 250V~ 10A - 250V~	21152	10		Rocker for Lighted Switches	90602 T	BR MF GE PE AL IS PM DU	20 2
	Rocker Push-button with Independent Pilot Lamp 10A - 250V~	21153	10		Rocker for Lighted Switches / Push-button with Lock Symbol	90794 T	BR MF GE PE AL IS PM DU	2
	Rocker Push-button with Orienting Light - 12V 6A - 12V	21162	10		Rocker for Lighted Switches / Push-button with Bell Symbol	90795 T	BR MF GE PE AL IS PM DU	2
					Rocker for Lighted Switches / Push-button with Maid Symbol	90796 T	BR MF GE PE AL IS PM DU	2
					Rocker for Lighted Switches / Push-button with Lamp Symbol	90797 T	BR MF GE PE AL IS PM DU	2





Legend: T - Rocker, Cover Plate or Frame. BR - White, MF - Ivory, GE - Ice, PE - Pearl, AL - Aluminium, IS - Gray, PM - Black, DU - Gold.  
Wiring diagrams can be found on pages 32 to 43.

Control devices			Rockers / Cover plates				
		Order code	Box (Un)		Order code	Color	Box (Un)
	Rocker Push-button with Identification - 250V~ 10A - 250V~	21155	10		Rocker for Switches with Identification Card	90603 T	BR MF GE PE AL IS PM DU 2
	Double Push-button (2NO+2NC) 10A - 250V~	21154	10				
	Double Push-button 10A - 250V~	21156	10		Double Rockers	90611 T	BR MF GE PE AL IS PM DU 20 2
	Rocker Push-button / Two-way Switch 10A - 250V~	21159	10				
	Rocker Push-button with Identification - 12V 6A - 12V	21165	10		Rocker for Switches with Identification Card	90603 T	BR MF GE PE AL IS PM DU 2
	Venetian Double Push-button 10A - 250V~	21281	10		Rockers for Venetian Push-buttons	90612 T	BR MF GE PE AL IS PM DU 20 2
	Blind push-button switch, turned contacts 10 A - 250 V	21282	10				
	Venetian Double Push-button for multiple points Blinds Control 10A - 250V~	21283	10		Rockers for Venetian Push-buttonswitch	90612 T	BR MF GE PE AL IS PM DU 20 2
	Venetian Switch 10A - 250V~	21290	10		Rockers for Venetian Switch	90613 T	BR MF GE PE AL IS PM DU 20 2
	Venetian Switch with Mechanical Blockage 10A - 250V~	21291	10				

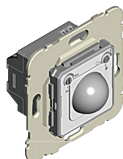





Legend: T - Rocker, Cover Plate or Frame. BR - White, MF - Ivory, GE - Ice, PE - Pearl, AL - Aluminium, IS - Gray, PM - Black, DU - Gold.  
 Wiring diagrams can be found on 32 to 43.





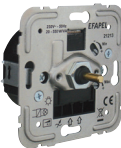

Control devices			Rockers / Cover plates			
	Order code	Box (Un)		Order code	Color	Box (Un)
	Rotary Two-way Switch - 16A 16AX - 250V~ - ON - OFF - ON.	21301	10		Cover Plate for Rotary Push-button / Two-way Switch	90761 T BR MF GE PE AL IS PM DU 2
	Rotary Switch - 16A 16AX - 250V~	21302	10		Cover Plate for Rotary Switch (ON/OFF)	90762 T BR MF GE PE AL IS PM DU 2
	Rotary Push-button - 16A 16A - 250V~ - ON - OFF - ON.	21303	10		Cover Plate for Rotary Push-button / Two-way Switch	90761 T BR MF GE PE AL IS PM DU 2
	Key Lock Push-button 10A - 250V~ - ON - OFF - ON. - It allows to remove the key in OFF position.	21351	10		Cover Plate for Key Lock Push-button / Two-way Switch	90351 T BR MF GE PE AL IS PM DU 1
	Key Lock Two-way Switch 10AX - 250V~ - ON - OFF - ON. - It allows to remove the key in 3 positions.	21352	10			
	One Circuit Digital Time Switch - Rated voltage: 230V~ - 50Hz. - Breaking capacity: 16A. - Output type: ON, OFF and PULSE.	21041	10		Cover Plate for One Circuit Digital Time Switch	90743 T BR MF GE PE AL IS PM DU 1
	Two Circuits Digital Time Switch - Rated voltage: 230V~ - 50Hz. - Breaking capacity: 6A + 6A. - Output type: ON, OFF and PULSE.	21042	10		Cover Plate for Two Circuits Digital Time Switch	90744 T BR MF GE PE AL IS PM DU 1
	Buzzer 230V~ - 50Hz - D type. - 5/15 sec.	21990	10		Cover Plate for Loud-speaker of 2" - 32 Ohm / Buzzer	90710 T BR MF GE PE AL IS PM DU 2

Control devices			Rockers / Cover plates			
	Order code	Box (Un)		Order code	Color	Box (Un)
 <p><b>General Blinds Control Module with Infrared Remote Control</b>            - Rated voltage: 230V~ - 50Hz.            - Breaking capacity: 6A.            - 2 programmable functions (Up/Down).            - Function: "Standby".</p>	21311	10	 <p>Cover Plate for General Blinds Control Module with Infrared Remote Control</p>	90311 T	BR MF GE PE AL IS PM DU	1
 <p><b>Local Blinds Control Module with Infrared Remote Control</b>            - Rated voltage: 230V~ - 50Hz.            - Breaking capacity: 6A.            - Possibility to be controlled by the Infrared Remote Control Transmitter for Blinds Control (Ref. 81901) or by the Infrared Remote Control Transmitter Multifunctions (Ref. 81900)</p>	21312	10	 <p>Cover Plate for Local Blinds Control Module with Infrared Remote Control</p>	90312 T	BR MF GE PE AL IS PM DU	1
 <p><b>Motion Detector - 1000W</b>            - Rated voltage: 230V~ - 50Hz.            - Sensibility regulation.            - Range of detection: 8 meters.            - Detection angle: 160°.            - Inverter contact (NO+NC), voltage free.</p>	21401	10	 <p>Cover Plate for Motion Detectors</p>	90401 T	BR MF GE PE AL IS PM DU	1
 <p><b>Motion Detector - 400W</b>            - Rated voltage: 230V~ - 50Hz.            - Sensibility regulation.            - Range of detection: 8 meters.            - Detection angle: 160°.            - Inverter contact (NO+NC), voltage free.</p>	21402	10				

Temperature Control			Rockers / Cover plates			
 <p><b>Programmable Chronothermostat</b>            - Rated voltage: 230V~ - 50Hz.            - Breaking capacity: 16A.            - Inverter contact (NO+NC), voltage free.            - Range of temperature readings: -9°C to 35°C.            - Optimized for electric or heating.            - Possibility of connecting the Floor Temperature Sensor (Ref. 81950), with automatic self detection.            Replace for 21230</p>	21232	1	 <p>Cover Plate for Programmable Chronothermostat</p>	90740 T	BR MF GE PE AL IS PM DU	1
 <p><b>Thermostat with Infrared Remote Control</b>            - Rated voltage: 230V~ - 50Hz.            - Breaking capacity: 16A.            - Inverter contact (NO+NC), voltage free.            - Range of temperature readings: -9°C to 35°C.            - Optimized for electric or heating.            Replace for 21231</p>	21233	1	 <p>Cover Plate for Thermostat with Infrared Remote Control</p>	90742 T	BR MF GE PE AL IS PM DU	1
 <p><b>Thermo sensor TC-3 for a simple programmable thermostat with infrared control</b>            - Length: 3 m            - Range: 0 to 70 °C            - IP67</p>	TC-3	1				

















Dimmers			Rockers / Cover plates				
	Order code	Box (Un)		Order code	Color	Box (Un)	
	Dimmer for Fluorescent Lamps with Electronic Ballast EVG 1-10V - IMax - 40mA. - Silent.	21210	1				
	Ferromagnetic Dimmer/ Two-way Switch - 500VA R, L - 20 - 500W/VA.	21211	1				
	Electronic Dimmer/Two-way Switch - 320W R, C - 5 - 320W. - Silent.	21212	1				
	Electronic Dimmer/Two-way Switch - 550W R, C - 20 - 550W/VA. - Silent.	21213	1		90721 T	BR MF GE PE AL IS PM DU	1
	Dimmer/Two-way Switch for Energy Saving Lamps - 110VA R, L - 7 - 110W/VA. - 3 - 35W LED's.	21214	1				
	Electronic Dimmer/Two-way Switch for Low Power Lamps - 150W R, C - 15 - 150W/VA. - 3 - 50W LED's. - Silent.	21215	1				
	Speed Controller for Induction Motors - 600VA - 25 - 600VA.	21219	1				
				See page 41 for the maximum load on dimmers.			

Energy sockets			Rockers / Cover plates (In the LOGUS <sup>90</sup> Medical Design - LR VD VM)				
	Earth Socket (French Type) with Screwless Terminals 16A - 250V~	21110	10		90652 T	BR MF LR VD VM GE PE AL IS PM DU	20 2
	Earth Socket (French Type) 16A - 250V~	21111	10		90654 T	BR MF GE PE AL IS PM DU	20 2
					90621 T	BR MF GE PE AL IS PM DU	20 2
	2P Socket 16A - 250V~	21121	10		90622 T	BR MF GE PE AL IS PM DU	20 2



Legend: T - Rocker, Cover Plate or Frame. BR - White, MF - Ivory, GE - Ice, PE - Pearl, AL - Aluminium, IS - Gray, PM - Black, DU - Gold.  
Wiring diagrams can be found on pages 32 to 43.

LOGUS<sup>90</sup> Medical Design:  
LR - Orange VD - Green VM - Red



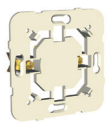

Energy sockets		Rockers / Cover plates (In the LOGUS <sup>90</sup> Medical Design - LR VD VM)						
		Order code	Box (Un)			Order code	Color	Box (Un)
 <p>Earth Socket (Schuko Type) with Screwless Terminals 16A - 250V~</p>	21130	10	 <p>Cover Plate for Earth Socket (Schuko Type)</p>	90631 T	BR MF LR VD VM GE PE AL IS PM DU	20 2		
			 <p>Safety Cover Plate for Earth Socket (Schuko Type)</p>	90632 T	BR MF LR VD VM GE PE AL IS PM DU	20 2		
			 <p><b>IP44</b> Cover Plate for Schuko Socket with Safety and Hinged Lid</p>	90634 T	BR MF GE PE AL IS PM DU	20 2		
 <p>Double Earth Socket (French Type) 16A - 250V~</p>	21470	10	 <p>Safety Cover Plate for Double Earth Socket (French)</p>	90656 T	BR MF LR VD VM GE PE AL IS	2		
 <p>Earth Socket (Schuko Type) 16A - 250V~</p>	21131	10	 <p>Cover Plate for Earth Socket (Schuko Type)</p>	90631 T	BR MF LR VD VM GE PE AL IS PM DU	20 2		
			 <p>Safety Cover Plate for Earth Socket (Schuko Type)</p>	90632 T	BR MF LR VD VM GE PE AL IS PM DU	20 2		
			 <p><b>IP44</b> Cover Plate for Schuko Socket with Safety and Hinged Lid</p>	90634T	BR MF GE PE AL IS PM DU	20 2		
 <p>Earth Socket (Euro-USA Type) 15A - 127V~ / 16A - 250V~</p>	21140	10	 <p>Cover Plate for Earth Socket (Euro-USA Type)</p>	90841 T	BR MF LR VD VM GE PE AL IS PM DU	20 2		
			 <p>Safety Cover Plate for Earth Socket (Euro-USA Type)</p>	90842 T	BR MF LR VD VM GE PE AL IS PM DU	20 2		
 <p>Earth Socket (USA NEMA Type) 15A - 127V~</p>	21143	10	 <p>Safety Cover Plate for Earth Socket (USA NEMA Type)</p>	90843 T	BR MF LR VD VM GE PE AL IS PM DU	20 2		

Legend: T - Rocker, Cover Plate or Frame. BR - White, MF - Ivory, GE - Ice, PE - Pearl, AL - Aluminium, IS - Gray, PM - Black, DU - Gold.

LOGUS<sup>90</sup> Medical Design:  
LR - Orange VD - Green VM - Red

Other Mechanisms			Rockers / Cover plates				
	Order code	Box (Un)		Order code	Color	Box (Un)	
 <p>Cable Outlet - Three Terminals - 3x2,5mm<sup>2</sup> - 250V~.</p>	21173	10	 <p>Cover Plate for Cable Outlets</p>	90671 T	BR MF GE PE AL IS PM DU	20 2	
 <p>Cable Outlet - Four Terminals - 4x2,5mm<sup>2</sup> - 250V~.</p>	21174	10					
 <p>Pilot Light - Max. 5W (E14) 250V~. - To be used with Lamp (Ref.81012)</p>	21360	10	<p>Cover for Pilot Light</p> 	 <p>Small E14 - 5W Lamp Order code: 81012</p>	90781 T	IC LR VD VM	2
 <p>Support for Blind Cover Plate</p>	21222	10	 <p>Blind cover plate</p>	90677 T	BR MF GE PE AL IS PM DU	10 2	
 <p>Screw Terminal Loudspeaker Socket</p>	21220	4	 <p>Cover Plate for Screw Terminal Loudspeaker Socket</p>	90713 T	BR MF GE PE AL IS PM DU	4 2	
 <p>PODA-275 Module of overvoltage protection SPD type 3</p>	6058	1					







IC - illuminated, transparent; LR - illuminated, orange; VD - illuminated, green; VM - illuminated, red

Data sockets			Rockers / Cover plates			
 <p>RJ45 Cat. 5e UTP Socket (Supplied with connector)</p>	21453	10	 <p>Cover Plate for Single RJ45 Computer Sockets</p>	90751 T	BR MF GE PE AL IS PM DU	20 2
 <p>RJ45 Cat. 6 UTP Socket (Supplied with connector)</p>	21455	10				
 <p>RJ45 Cat. 5e STP Socket (Supplied with connector)</p>	21443	10				
 <p>RJ45 Cat. 6 STP Socket (Supplied with connector)</p>	21445	10				

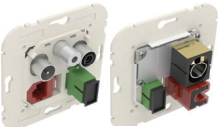

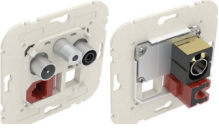
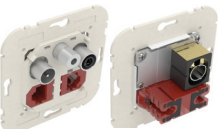

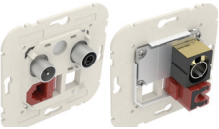
Telephone socket				Rockers / Cover plates				
50V---70V~	Order code	Color	Box (Un)		Order code	Color	Box (Un)	
	21252 S*	BR MF CZ AT	10		90712 T	BR MF GE PE AL IS PM DU	20 2	
	21253 S*	BR MF CZ AT	10					
	21411	-	10		90718 T	BR MF GE PE AL IS PM DU	20 2	

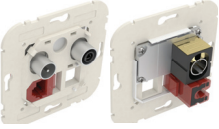
Radio, television and satellite sockets				Rockers / Cover plates				
<b>Series connection</b>								
	R - TV - SAT Socket (Terminal Type) - series connection - 4 - 2400 MHz: < 5dB. - Current flow - 500mA (DC).	21555	10		90775 T	BR MF GE PE AL IS PM DU	10 5	
	R - TV - SAT Socket (Crossover Type) - 4 - 2400 MHz: < 9dB. - Current flow - 500mA (DC). - Insertion losses: 2dB.	21565	10					
	R - TV Socket (Terminal Type) - 4 - 82 MHz: < 5dB. - 84 - 108 MHz: < 6dB. - 112 - 1000 MHz: < 5dB.	21554	10		90776 T	BR MF GE PE AL IS PM DU	10 5	
	R - TV Socket (Crossover Type) - 4 - 1000 MHz: < 9dB. - Insertion losses: 2dB.	21564	10					
<b>Star connection</b>								
	R - TV Socket Star Connection - star connection - 4 - 82 MHz: < 1dB. - 84 - 108 MHz: < 2dB. - 112 - 1000 MHz: < 1dB.	21533 Replace for 21530	10		90776 T	BR MF GE PE AL IS PM DU	10 5	
	R - TV - SAT Socket Star Connection - 4 - 862 MHz: < 1dB. - 950 - 2400 MHz: < 3dB. - Current ow - 500mA (DC).	21543	10		90775 T	BR MF GE PE AL IS PM DU	10 5	

Legend: T - Rocker, Cover Plate or Frame. BR - White, MF - Ivory, GE - Ice, PE - Pearl, AL - Aluminium, IS - Gray, PM - Black, DU - Gold.  
Wiring diagrams can be found on pages 32 to 43. Rear view: [www.elkoep.com/sockets](http://www.elkoep.com/sockets).





Multimedia socket			Rockers / Cover plates					
	Order code	Box (Un)		Order code	Color	Box (Un)		
<b>Star connection</b>								
	R - TV - SAT - RJ45 Cat. 6 UTP - FO SC-APC Multimedia Socket for Star Connection - 4 - 862 MHz: < 1dB. - 950 - 2400 MHz: < 3dB. - Current flow - 500mA (DC).	21545	10		Cover Plate for R - TV - SAT - RJ45 / R - TV - SAT - RJ45 - FO Multimedia Sockets	90770 T	BR MF GE PE AL IS PM DU	10 5
	R - TV - SAT - RJ45 Cat. 6 UTP Multimedia Socket for Star Connection - To be used with a SC APC Simplex or LC Duplex Fibre Optic Connector - 4 - 862 MHz: < 1dB. - 950 - 2400 MHz: < 3dB. - Current flow - 500mA (DC).	21544	10					
	R - TV - SAT - 2xRJ45 Cat. 6 UTP Multimedia Socket for Star Connection - 4 - 862 MHz: < 1dB. - 950 - 2400 MHz: < 3dB. - Current flow - 500mA (DC).	21546	10		Cover Plate for R - TV - SAT - 2xRJ45 Multimedia Socket	90773 T	BR MF GE PE AL IS PM DU	10 5
	R - TV - RJ45 Cat. 6 UTP - FO SC-APC Multimedia Socket for Star Connection - 4 - 82 MHz: < 1dB. - 84 - 108 MHz: < 2dB. - 112 - 1000 MHz: < 1dB.	21535	10		Cover Plate for R - TV - RJ45 / R - TV - RJ45 - FO Multimedia Sockets	90774 T	BR MF GE PE AL IS PM DU	10 5
	R - TV - RJ45 Cat. 6 UTP Multimedia Socket for Star Connection - 4 - 82 MHz: < 1dB. - 84 - 108 MHz: < 2dB. - 112 - 1000 MHz: < 1dB.	21534	10					



Rear view: [www.elkoep.com/multimedia](http://www.elkoep.com/multimedia)



RJ45 connectors			Rockers / Cover plates					
	RJ45 Cat. 5e UTP Connector (100 MHz)	21975	5					
	RJ45 Cat. 6 UTP Connector (250 MHz)	21978	5					
	RJ45 Cat. 5e STP Connector (100 MHz)	21985	5					
	RJ45 Cat. 6 STP Connector (250 MHz)	21988	5		Cover Ring with Double Support for RJ45 Connectors	90442 S	BR MF GE PE AL IS PM DU	20 2
	Double RJ45 Cat. 5e UTP Connector (1 input / 2 outputs)	21980	5					
	Telephone Plug - 6 Positions with 4 Contacts (Plug 6x4)	82025	50					
	Telephone Plug - 6 Positions with 6 Contacts (Plug 6x6)	82026	50					

Legend: S - Semi-assembled.; T - Rocker, Cover Plate or Frame. BR - White, MF - Ivory, GE - Ice , PE - Pearl, AL - Aluminium, IS - Gray, PM - Black, DU - Gold.  
Wiring diagrams can be found on pages 32 to 43.

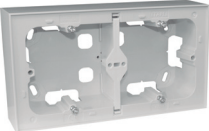
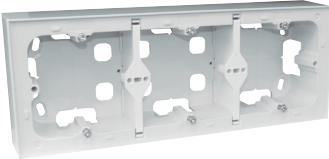

Couplers for fibre optic connectors			Rockers / Cover plates				
	Order code	Box (Un)		Order code	Color	Box (Un)	
	Coupler for SC APC Duplex Fibre Optic Connector	82211	10		Cover Plate for Coupler for SC APC Duplex Fibre Optic Connector	90448 S BR MF GE PE AL IS PM DU	10
	Coupler for SC APC Simplex Fibre Optic Connector	82210	10		Cover Plate for Coupler for SC APC Simplex / LC Duplex Fibre Optic Connector	90449 S BR MF GE PE AL IS PM DU	10
	Coupler for LC Duplex Fibre Optic Connector	82213	10				

USB sockets			Rockers / Cover plates				
	<p>Double USB Charger Type A with Output at 20°</p> <ul style="list-style-type: none"> <li>- Voltage: 100-240 V~.</li> <li>- Frequency: 50-60 Hz.</li> <li>- Output voltage: 5V.</li> <li>- Output current: 2.4A.</li> <li>- Two USB type A outlets.</li> </ul>	21384	1		Cover Plate for Double USB Charger Type A with outlets at 20°	90673 T BR MF GE PE AL IS DU PM	1

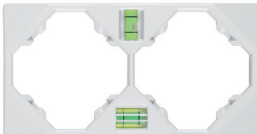
Accessories						
	LOGUS <sup>90</sup> Series   QUADRO 45 Series Surface Mounting Box - To be used only with Single Frames in the QUADRO 45 Series. 85 x 85 x 40 mm	10976 A	BR MF GE PE AL IS DU PM	10		
	LOGUS <sup>90</sup> Series   Double Surface Mounting Box Accessories for mounting flush mounting devices 85 x 160 x 40 mm	10994 A	BR MF GE PE AL IS DU PM	5		
	LOGUS <sup>90</sup> Series   Triple Surface Mounting Box Accessories for mounting flush mounting devices 85 x 230 x 40 mm	10995 A	BR MF GE PE AL IS DU PM	1		
	Cover for Mechanisms Protection 85 x 85 x 8.5 mm	21971	-	40		
	Level and Mounting Accessory for MEC 21 Mechanism 85 x 227 x 8.5 mm	21989	-	20		

Legend: S - Semi-assembled.; A - Accessories. T - Rocker, Cover Plate or Frame; Dimensions: H x W x D.  
BR - White, MF - Ivory, GE - Ice, PE - Pearl, AL - Aluminium, IS - Gray, PM - Black, DU - Gold.

## Accessories

		Order code	Color	Box (Un)
	Card for Card-system Switch 85 x 298 x 8.5 mm	21999	-	5 2
	21470 Universal Cover Ring / Adapter for 45x45 Modules 85 x 85 x 8.5 mm	90881 T	BR MF VM GE PE AL IS PM DU	2
	Relay for Blinds Control - Rated voltage: 230V~ – 50Hz. - Breaking capacity: 6A. - Not temporized. - Connect locally to Venetian Double Push-button (Ref. 21283 / 45283 S). - For the centralized command of the installation, connect remotely to a Venetian Double Push-button (Ref. 21283 / 45283 S). • See Technical Data Sheet - page 40	81511	-	1
	Automatic Relay for Blinds Control - Rated voltage: 230V~ – 50Hz. - Breaking capacity: 6A. - Temporized. - Connect to the Double Push-buttons and to the Venetian Double Push-buttons. • See Technical Data Sheet - page 39	81512	-	1
	Infrared Remote Control Transmitter for Blinds Control - 4 groups of buttons with 2 programmable functions. - It works with 2 AAA batteries, not included.	81901	-	1
	Infrared Remote Control Transmitter for Thermostat - 2 groups of buttons to associate with Blinds Control. - It works with 2 AAA batteries, not included.	81902	-	1
	Waterproof Frame IP44	90961 T	BR MF GE PE AL IS PM DU	1
	IP44 Kit for MEC 21 Mechanisms - Single Rocker	21981	-	1
	IP44 Kit for MEC 21 Mechanisms - Double Rockers	21982	-	1
	Replacement LED for MEC 21 / 48 Series - 12V	81018	-	10
	Replacement LED for MEC 21 / 48 Series - 250V~	81019	-	10











Legend: T - Rocker, Cover Plate or Frame. Dimensions: H x W x D.

BR - White, MF - Ivory, GE - Ice, PE - Pearl, AL - Aluminium, IS - Gray, VM - Red, PM - Black, DU - Gold.

## Semi-assembled (Supplied without connectors)

	Order code	Color	Box (Un)
 Data socket RJ45 2 outputs (without connectors)	90450 S (a)	BR MF GE PE AL IS	10









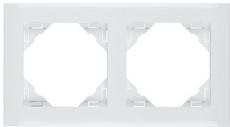

## Complete devices

 Monoblock Earth Socket (Schuko Type) 16A - 250V~	90135 C	BR MF GE PE AL IS PM DU	10
 Monoblock Safety Earth Socket (Schuko Type), with safety diaphragm 16A - 250V~	90138 C	BR MF GE PE AL IS PM DU	10
 Monoblock Safety Earth Socket (Schuko Type) with safety diaphragm 16A - 250V~	90139 C	BR MF GE PE AL IS PM DU	10
 Earth Socket (British Type) with Switch and Pilot Lamp 13A - 250V~	90183 C	BR MF GE PE AL IS PM DU	10
 Earth Socket (British Type) 13A - 250V~	90184 C	BR MF GE PE AL IS PM DU	10
 Double Earth Socket (British Type) with Switch and Pilot Lamp 13A - 250V~	90343 C	BR MF GE PE AL IS PM DU	5
 Double Earth Socket (British Type) 13A - 250V~	90344 C	BR MF GE PE AL IS PM DU	5
 Monoblock Double Earth Socket (Schuko Type) 16A - 250V~	90331 C	BR MF GE PE AL IS PM DU	10
 Monoblock Double Safety Earth Socket (Schuko Type) 16A - 250V~	90332 C	BR MF GE PE AL IS PM DU	10
 Electronic Dimmer/Two-way Switch - 320W R, C - 5-320W. - Silent.	90212 C	BR MF GE PE AL IS PM DU	1

Legend: C - Complete devices; S - Semi-assembled. BR - White; MF - Ivory; GE - Ice; PE - Pearl; AL - Aluminium; IS - Gray, PM - Black, DU - Gold.

To obtain complete or semi-assemblies in the CRYSTAL, METALLO, ARBORE or PETRA series, replace the AQUARELLA frames with the appropriate row.

## Frames - BASE series

		Order code	Color	Box (Un)
	Single Frame	90910 T	BR MF	20
	Double Frame	90920 T	BR MF	10
	Triple Frame	90930 T	BR MF	10
	Four-Gang Frame	90940 T	BR MF	2
	Five-Gang Frame	90950 T	BR MF	2
	Monoblock Cover for Earth Socket (Schuko Type)	90902 T	BR MF GE PE AL IS PM DU	20
	Monoblock Cover for Safety Earth Socket (Schuko Type)	90903 T	BR MF GE PE AL IS PM DU	20
	Monoblock Cover for Safety Earth Socket (French Type)	90904 T	BR MF GE PE AL IS PM DU	20
	Back Plate + cover for Antenna socket R + TV	90905 T	BR MF	20
	Back plate + cover of R TV + SAT socket	90906 T	BR MF	2
	Back Plate + cover for Data socket R TV + DAT	90907 T	BR MF	2

Frames - AQUARELLA series

		Order code	Color	Box (Un)
	Single Frame	90910 T	GE PE AL IS PM DU	2
	Double Frame	90920 T	GE PE AL IS PM DU	2
	Triple Frame	90930 T	GE PE AL IS PM DU	2
	Four-Gang Frame	90940 T	GE PE AL IS PM DU	2
	Five-Gang Frame	90950 T	GE PE AL IS PM DU	2

Legend: T - Rocker, Cover Plate or Frame. GE - Ice, PE - Pearl, AL - Aluminium, IS - Gray, PM - Black, DU - Gold.

Frames - ANIMATO series



		Order code	Color	Box (Un)
	Single Frame	90910 T	BB EE MM PP RG TS DG BS ZG AA JG AS VG SS PS PG RR PA UG UU	2
	Double Frame	90920 T	BB EE MM PP RG TS DG BS ZG AA JG AS VG SS PS PG RR PA UG UU	2
	Triple Frame	90930 T	BB EE MM PP RG TS DG BS ZG AA JG AS VG SS PS PG RR PA UG UU	2
	Four-Gang Frame	90940 T	BB EE MM PP RG TS DG BS ZG AA JG AS VG SS PS PG RR PA UG UU	2

Legend: T - Rocker, Cover Plate or Frame.

BB - White/White, EE - Ice/Ice, MM - Ivory/Ivory, PP - Pearl/Pearl, RG - Yellow/Ice, TS - Brick/Gray, DG - Green/Ice, BS - Wine/Gray, ZG - Blue/Ice, AA - Aluminium/Aluminium, JG - Orange/Ice, AS - Aluminium/Gray, VG - Red/Ice, SS - Gray/Gray, PS - Black/Gray, PG - Black/Ice, RR - Black/Black, PA - Black/Aluminium, UG - Gold/Ice, UU - Gold/Gold.

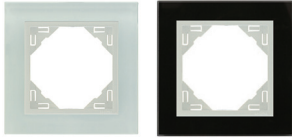
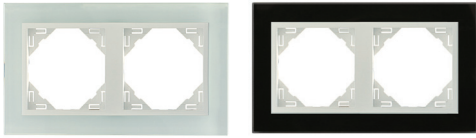

## Frames - CRYSTAL series

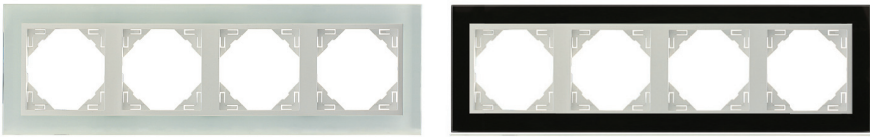
		Order code	Color	Box (Un)
	Single Frame	90910 T/ 90910 E	CG CP CA CS/ EC EG EA ES EP	1
	Double Frame	90920 T/ 90920 E	CG CP CA CS/ EC EG EA ES EP	1
	Triple Frame	90930 T/ 90930 E	CG CP CA CS/ EC EG EA ES EP	1
	Four-Gang Frame	90940 T/ 90940 E	CG CP CA CS/ EC EG EA ES EP	1

Legend: T/E - Rocker, Cover Plate or Frame. CG - Cristal/Ice; CP - Cristal/Pearl; CA - Cristal/Aluminium; CS - Cristal/Gray; EC - Glass - black/Pearl; EG - Glass - black/Ice; EA - Glass - black/Aluminium; ES - Glass - black/Gray, EP - Glass - black/Black.

## Frames - METALLO series

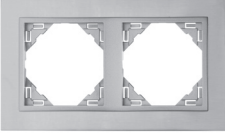
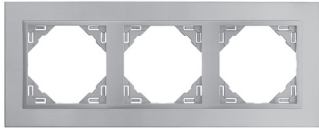
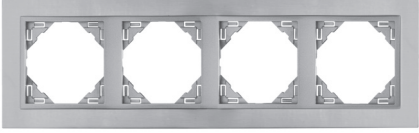
		Order code	Color	Box (Un)
	Single Frame	90910 T	TP IA OP QS US RS UU	1
	Double Frame	90920 T	TP IA OP QS US RS UU	1
	Triple Frame	90930 T	TP IA OP QS US RS UU	1
	Four-Gang Frame	90940 T	TP IA OP QS US RS UU	1

Legend: T - Rocker, Cover Plate or Frame. TP - Titanium/Pearl; IA- Inox/Aluminium; OP- Gold/Pearl; QS - Nickel/Gray; US - Aluminium/Gray; RS - Chrome/Gray; UU - Gold/Gold.

## Frames - ARBORE series

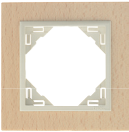
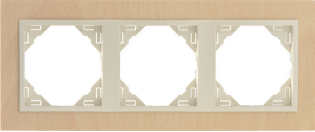
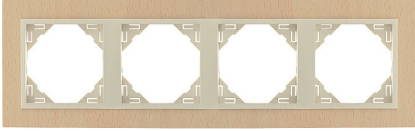
		Order code	Color	Box (Un)
	Single Frame	90910 T	FP JP MS NA	1
	Double Frame	90920 T	FP JP MS NA	1
	Triple Frame	90930 T	FP JP MS NA	1
	Four-Gang Frame	90940 C	FP JP MS NA	1

Legend: T - Rocker, Cover Plate or Frame. FP - Beach Wood/Pearl, JP - Cherry Tree /Pearl, MS - Mahogany/Gray, NA - Walnut Tree/Aluminium.

## Frames - PETRA series

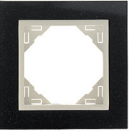
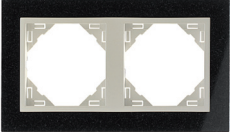
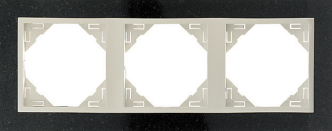
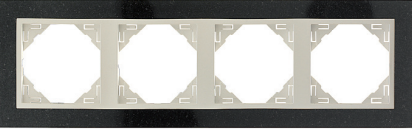
		Order code	Color	Box (Un)
	Single Frame	90910 T	GG GP GA GS	1
	Double Frame	90920 T	GG GP GA GS	1
	Triple Frame	90930 T	GG GP GA GS	1
	Four-Gang Frame	90940 C	GG GP GA GS	1

Legend: T - Rocker, Cover Plate or Frame. GG - Granite/Ice; GP - Granite/Pearl; GA - Granite/Aluminium; GS - Granite/Gray.

## Frames - Dimensions (mm) - BASE and AQUARELLA

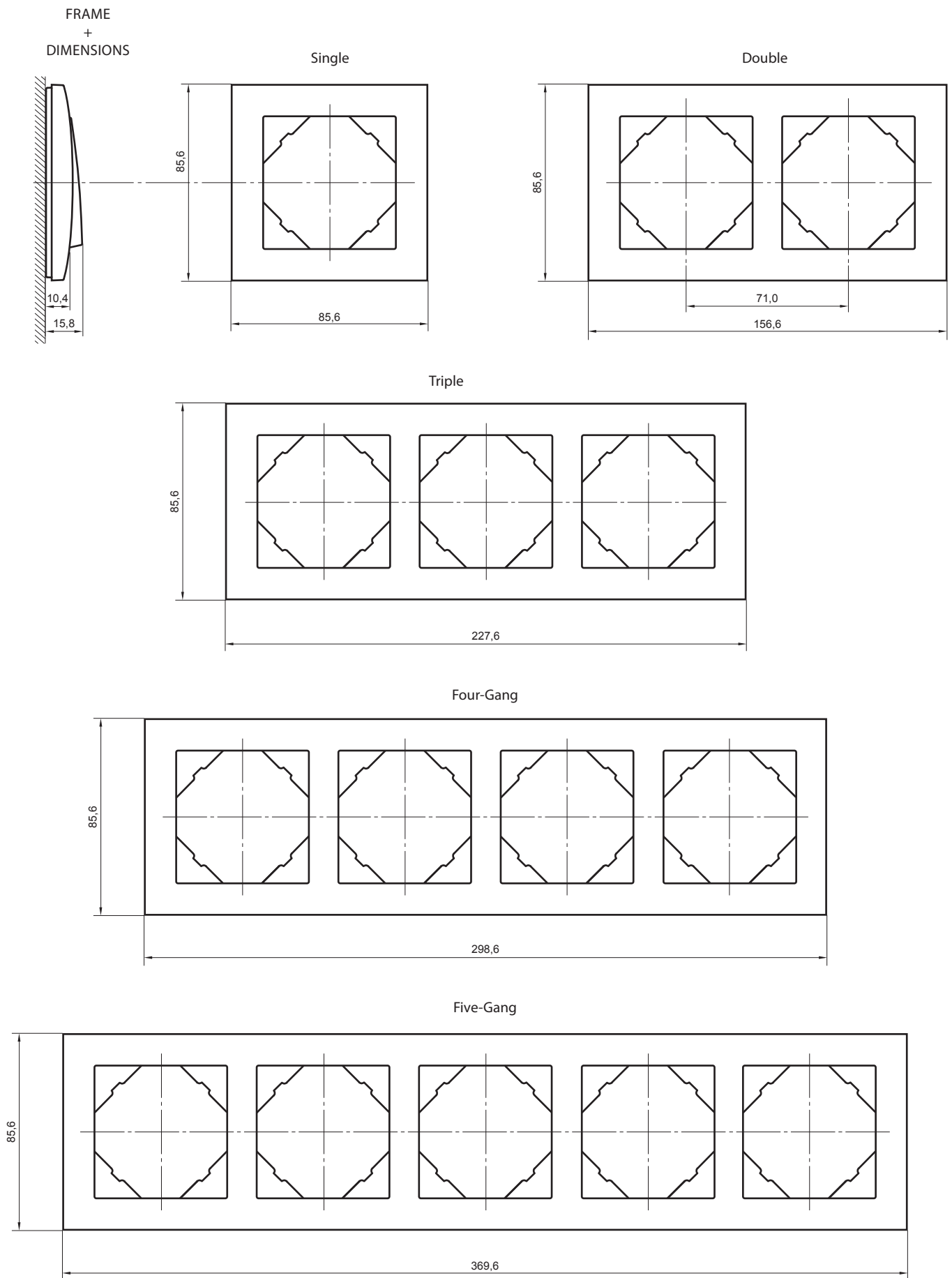

## Frames - Dimensions (mm) - ANIMATO, CRYSTAL, METALLO, ARBORE and PETRA

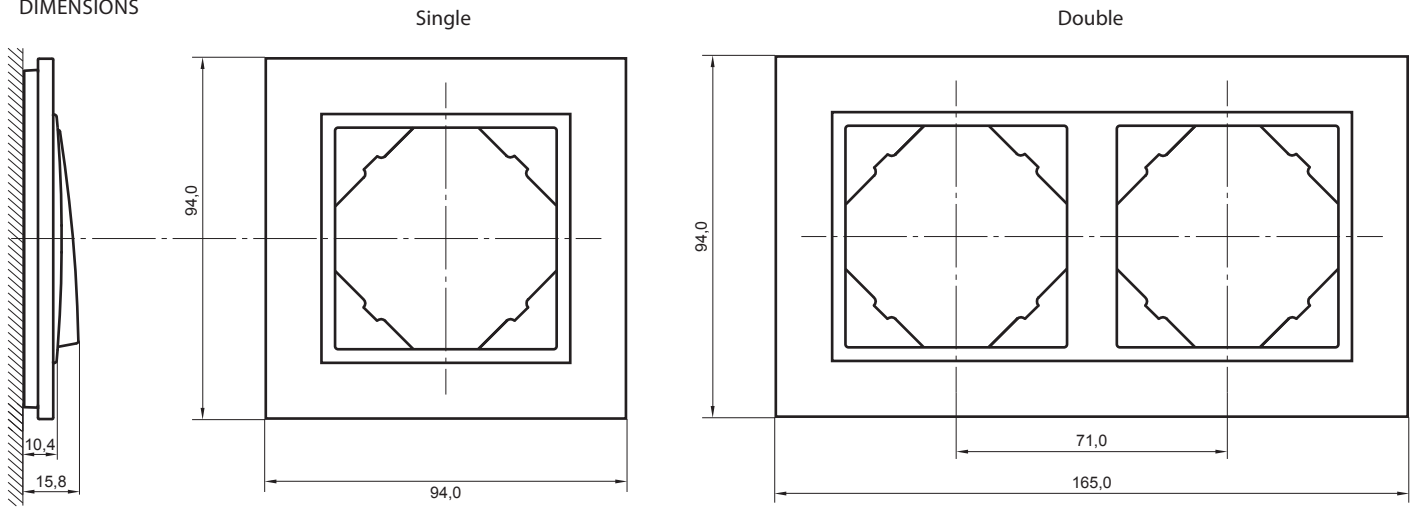
FRAME  
+  
DIMENSIONS

Triple

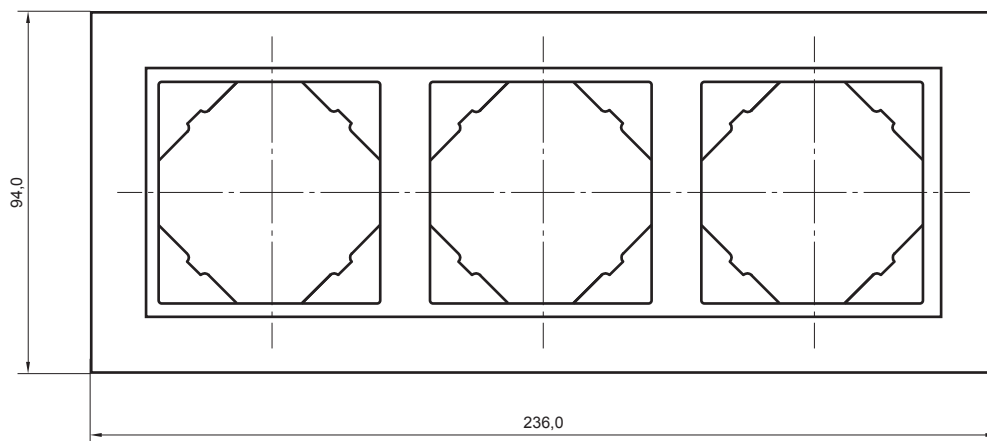

Four-Gang

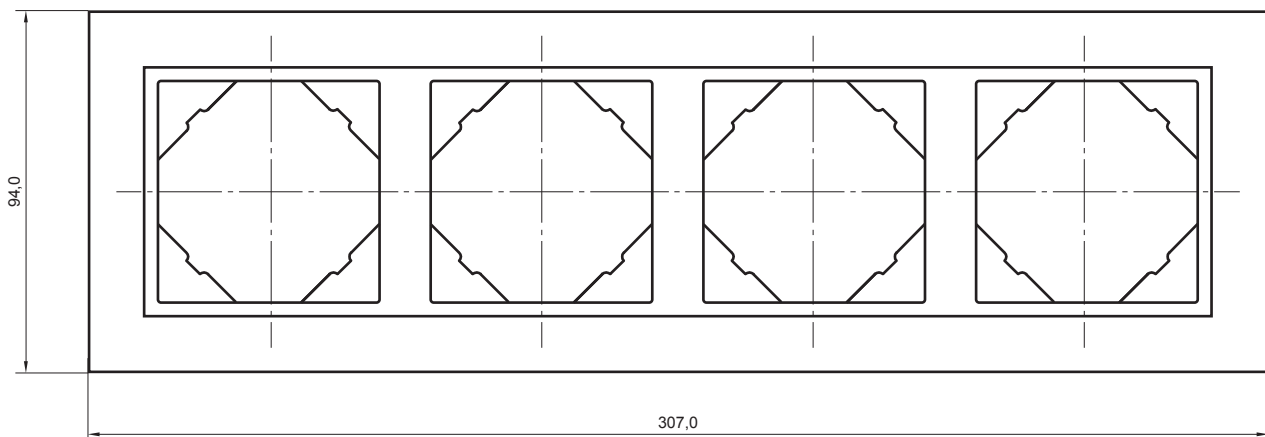

Devices designed for the LOGUS<sup>90</sup> design line

SINGLE POLE SWITCH

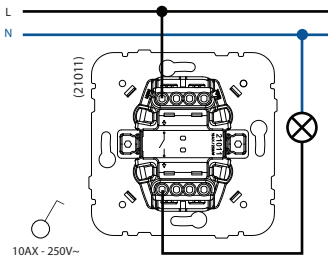

SINGLE POLE SWITCH WITH ORIENTING LIGHT

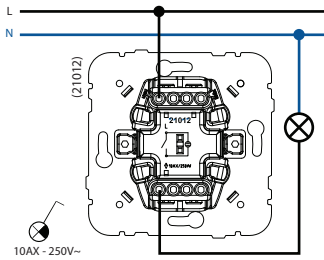

SINGLE POLE SWITCH WITH PILOT LAMP

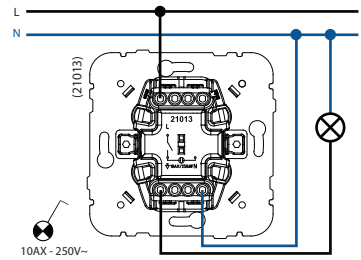

TWO-POLE SWITCH

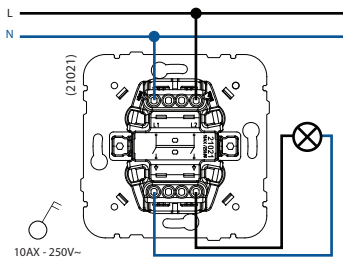

TWO-POLE SWITCH WITH PILOT LAMP

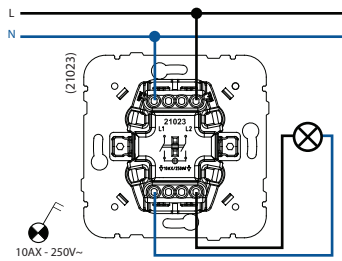

TWO-POLE SWITCH WITH PILOT LAMP - 20A

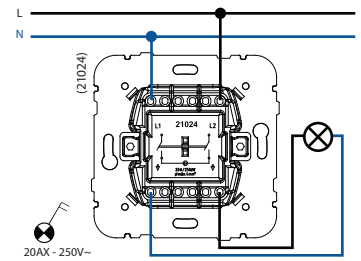

CARD-SYSTEM SWITCH

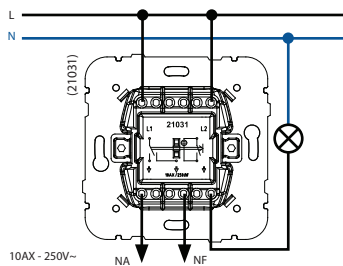

TWO CIRCUITS SWITCH

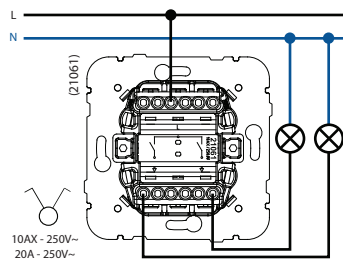

THREE CIRCUITS SWITCH

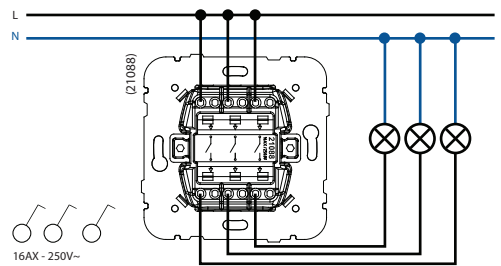

TWO-WAY SWITCH - 10A AND 20A

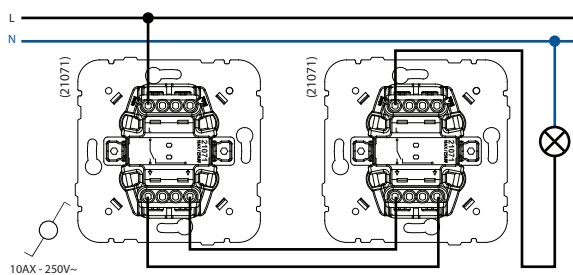

TWO-WAY SWITCH WITH ORIENTING LIGHT

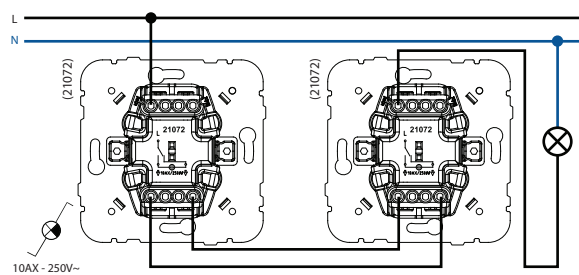



Devices designed for the LOGUS<sup>90</sup> design line

TWO-WAY SWITCH WITH PILOT LAMP

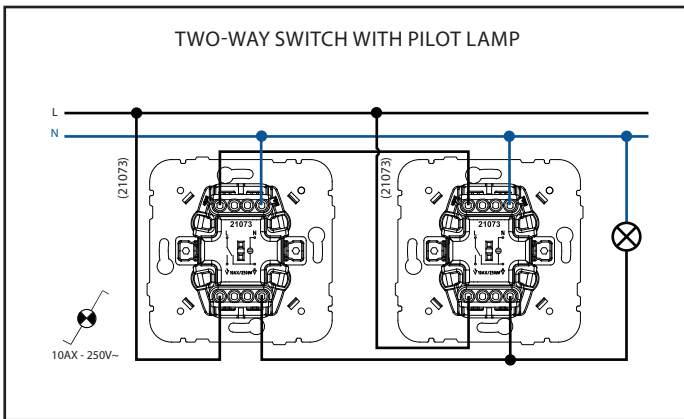

DOUBLE TWO-WAY SWITCH - 10A AND 20A

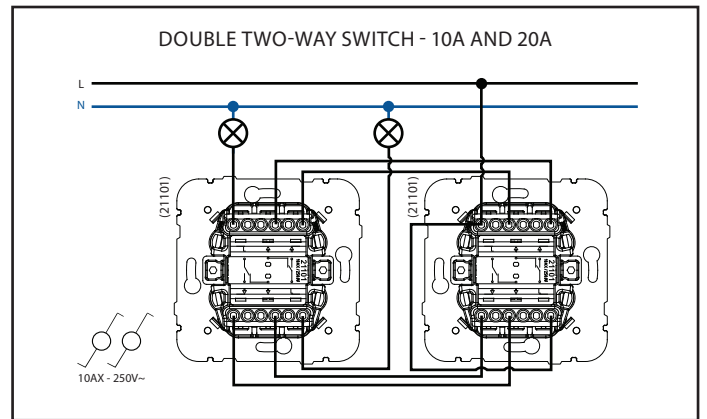

INTERMEDIATE SWITCH

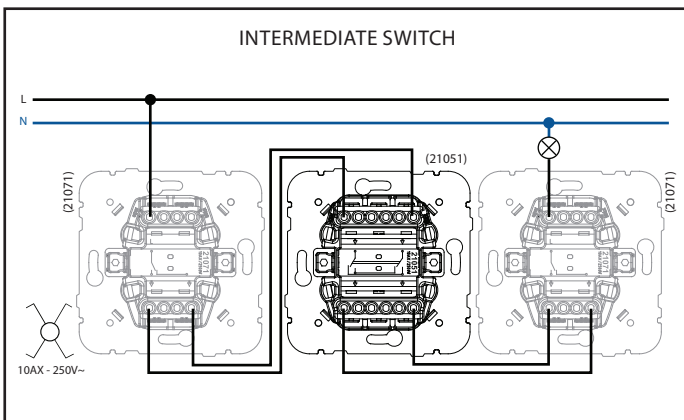

INTERMEDIATE SWITCH WITH ORIENTING LIGHT

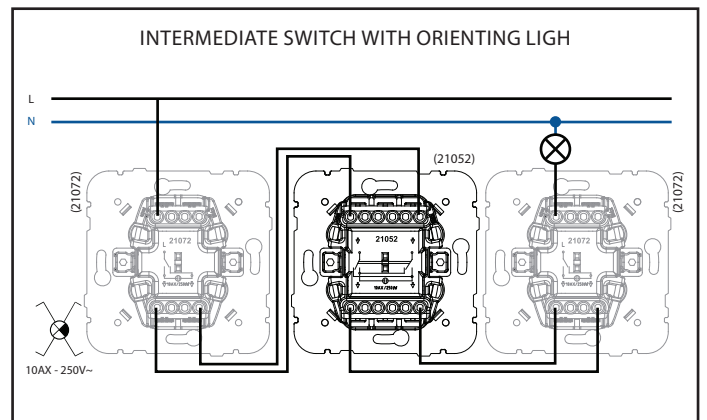

ROCKER PUSH-BUTTON

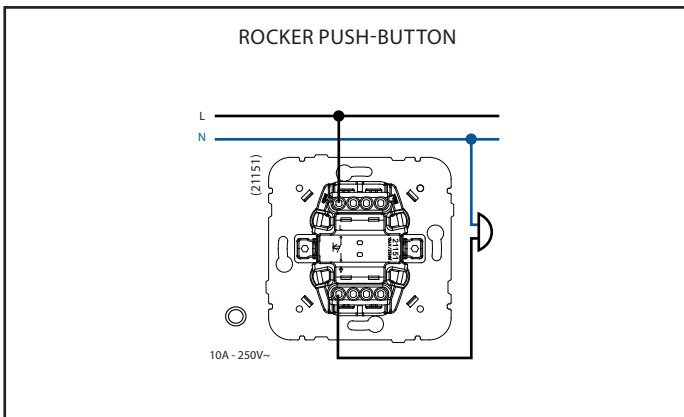

ROCKER PUSH-BUTTON (NO+NC)

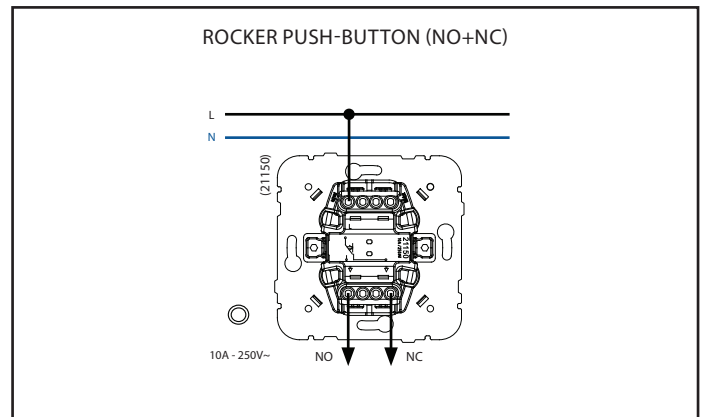

ROCKER PUSH-BUTTON WITH ORIENTING LIGHT - 250V~

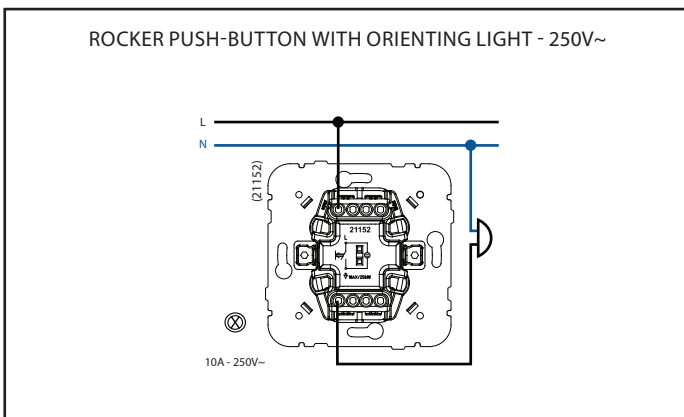

ROCKER PUSH-BUTTON WITH ORIENTING LIGHT - 12V

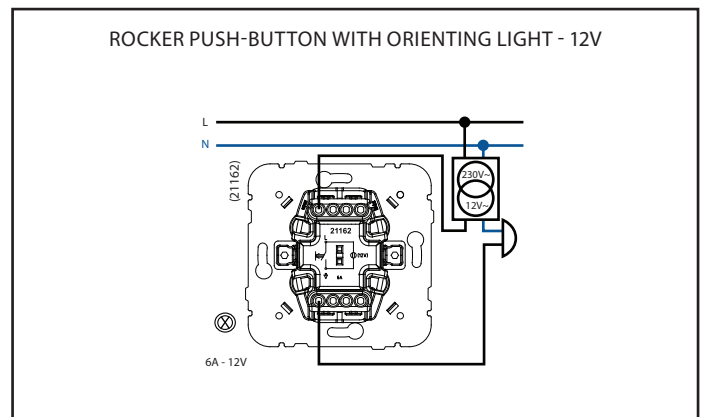

Devices designed for the LOGUS<sup>90</sup> design line

ROCKER PUSH-BUTTON WITH INDEPENDENT PILOT LAMP

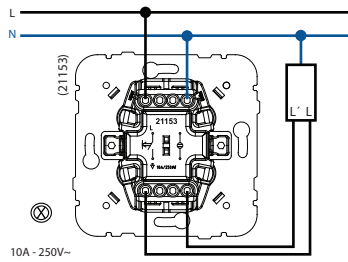

ROCKER PUSH-BUTTON WITH IDENTIFICATION 250V~

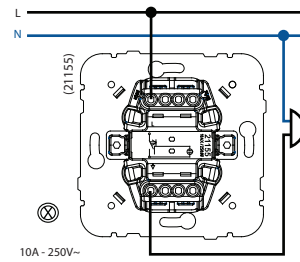

ROCKER PUSH-BUTTON WITH IDENTIFICATION 12V

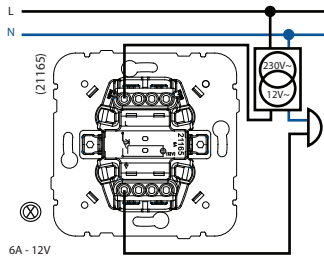

DOUBLE PUSH-BUTTON

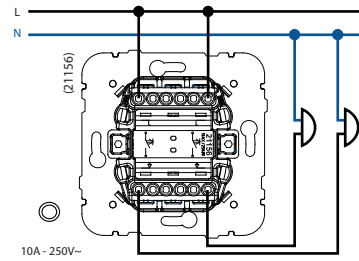
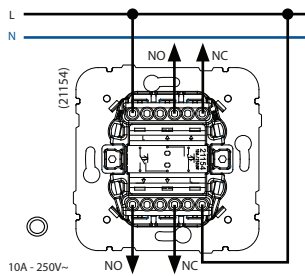
DOUBLE PUSH-BUTTON  
(2NO+2NC)

ROCKER PUSH-BUTTON / TWO-WAY SWITCH

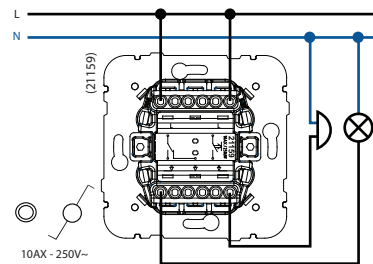

VENETIAN SWITCH WITH MECHANICAL BLOCKAGE

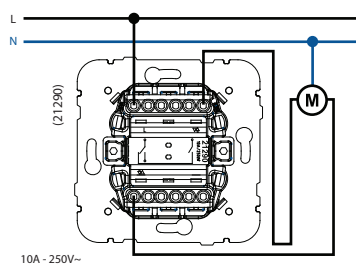

VENETIAN DOUBLE PUSH-BUTTON

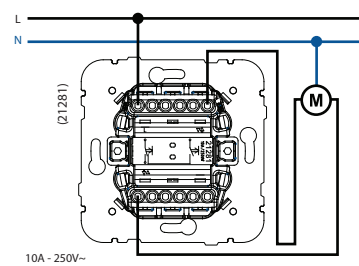

Devices designed for the LOGUS<sup>90</sup> design line

VENETIAN DOUBLE PUSH-BUTTON FOR MULTIPLE POINTS BLINDS CONTROL (Control for 1 point)

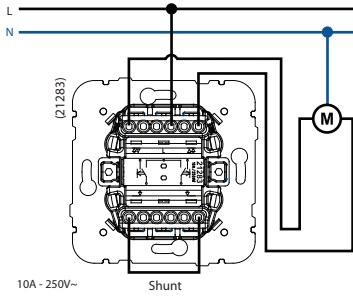

VENETIAN DOUBLE PUSH-BUTTON FOR MULTIPLE POINTS BLINDS CONTROL (Control from 2 or several points)

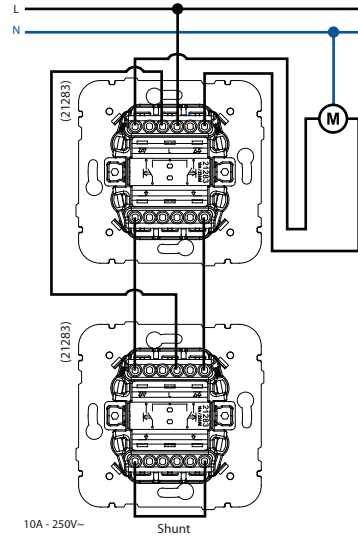

ROTARY TWO-WAY SWITCH - 16A ROTARY PUSH-BUTTON

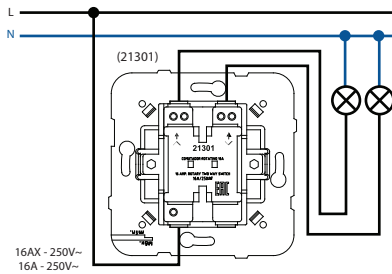

ROTARY SWITCH - 16A PULL-CORD PUSH-BUTTON

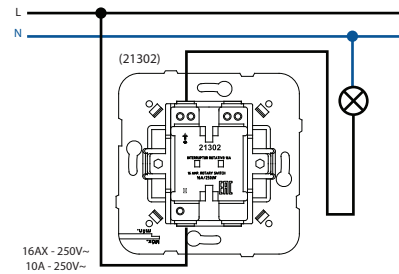

KEY LOCK TWO-WAY SWITCH KEY LOCK PUSH-BUTTON

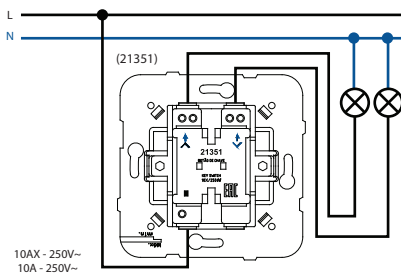

PULL-CORD TWO-WAY SWITCH

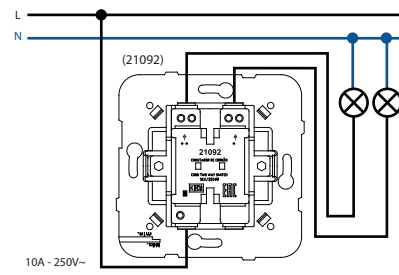

## Motion detector (NO+NC)



Motion Detector - 1000W (Order code 21401/45401 S)  
Motion Detector - 400W (Order code 21402/45402 S)

Controls the connection of electrical circuits according to the detection of motion and surrounding luminosity.  
Compatible with any electrical load.  
Wall mounting.

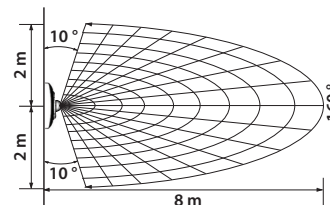

Technical parameters	Order code 21401/45401 S	Order code 21402/45402 S
Voltage range:	230 V~ - 50/60 Hz	
Consumption:	1 W	
Max. Light load:	1000 W	400 W
Sensitivity regulation:	√	
Operating time regulation:	5 sek. to 5 min.	
Range of detection:	8 m	
Detection angle:	160°	
Outputs:	NO / NC	

NB: NO - normally open; NC - normally closed.

## • Operatin

1. Remove the cover of the mechanism to reach the adjustments potentiometers.
2. Proceed to make the necessary adjustments.

## • Connection

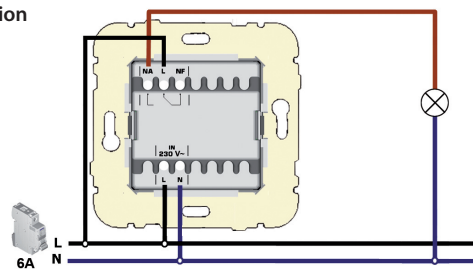

Operating Time Regulation

Sensibility Regulation



## Dimmer



Electronic Dimmer/Two-way Switch  
- 320W R, C (Order code 21212)

Allows to adjust the luminous flux of one or more lamps.

Technical parameters	Order code 21212
Maximum load:	320 W
Minimum load:	5 W
Two-way function	
Switches:	√
Minimum intensity setting:	*
Fuse:	—
Bulbs:	√
Halogen lamps, 230 V ~:	√
Halogen lamps with ferromagnetic transformer:	—
Halogen lamps with electronic transformer:	√

Note: \* - automatic setting

## • Settings

Turn the potentiometer to adjust the intensity of the lamp or group of luminaires.

By pressing the button, the switch switches to the two-way dimmer function.

Check voltage on the bottom edge.

(Order code 21212)

## • Connection

Electronic Dimmer/Two-way Switch

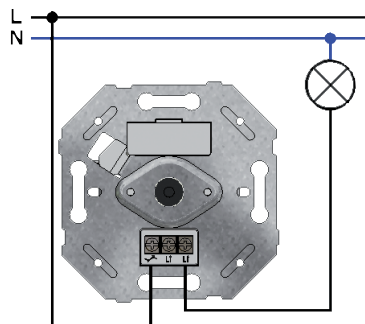

Two-way dimmer

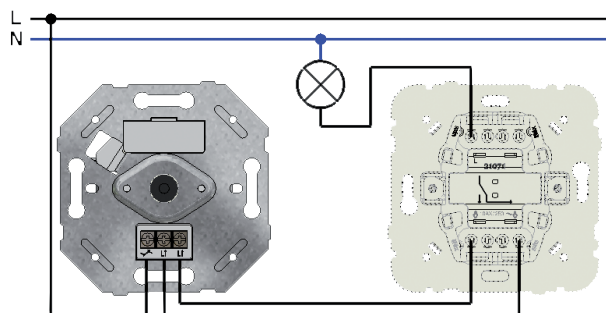

Digital Time Switch



One Circuit Digital Time Switch (Order code 21041)  
Two Circuits Digital Time Switch (Order code 21042)

The Digital Time Switch allows to control an installation or equipment according to daily or weekly programmed schedule. Includes capacity for 24 different program settings. Automatic Winter-Summer official time adjustment and possibility of programming a period of inactivity (holydays).

Technical parameters	Order code 21041	Order code 21042
Voltage range:	230 V / 50 Hz	
Power consumption:	1 W	
Breaking capacity:	6 A	6 A + 6 A
Programming accuracy:	1 s.	
Operating accuracy:	< 1 s / day	
Memory capacity:	32	
Output type:	ON - OFF - Pulz (1 to 59 s)	
Outputs:	NO and NC	2 NO and 2 NC
Block function:	✓	
Backup battery:	✓	

NB: NO - normally open; NC - normally closed.

• Connection

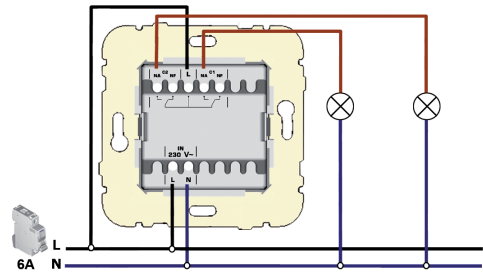

• Settings

- C1 - Manual Channel 1, Decrease - Move down (in the menu)
- C2 - Manual mode channel 2, Increase value - Go up in the menu
- OK / Menu - Start Menu / Confirm Selection
- STANDBY - Stop programming

Programmable Chronothermostat



Programmable Chronothermostat  
(Order code 21232/45232 S)

It allows to control manually or automatically the heating/cooling system in accordance with a daily/weekly programming and with preprogrammed temperatures. Automatic winter/summer time change. Possibility of programming a period of inactivity (holydays).

Technical parameters	Order code 21232/45232 S	Order code 21233/45233 S
Voltage range:	230 V / 50 Hz	
Consumption:	1 W	
Breaking capacity:	16 A	
Adjustable:	✓	—
Sensitivity:	1 °C	
Range of temperatures readings:	0 to 35°C	
Timer:	—	15 to 90 min
Holiday program:	✓	—
IR remote control:	—	✓
Non-voltage contacts:	✓	
Memory Backup Time:	3 h	

• Settings (Order code 21232/45232 S)

- ▼ - Decline in values. Movements within the menu. Minimum temperature options. Manual switch to minimum temperature
- ▲ - The rise in values. Movements within the menu. Choosing the maximum temperature. Manual switch to maximum temperature
- C - Input Confirmation / Menu Access
- OK - Wiring / connecting the device. Delete action

Thermostat with Infrared Remote Control



Thermostat with Infrared Remote Control  
(Order code 21233/45233 S)

Allows to control the heating or cooling system in accordance with the required temperature. Possibility of connecting the Floor Temperature Sensor, with automatic self detection. Possibility to be controlled by the Infrared Remote Control Transmitter.

• Connection

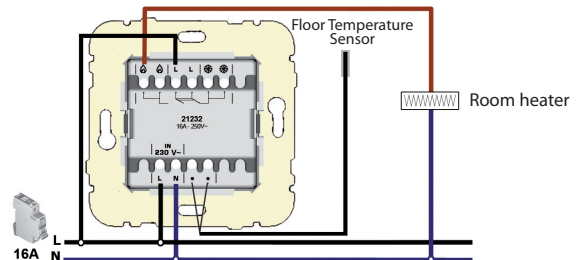

• Settings (Order code 21233/45233 S)

- ▼ - Temperature drop. Drop in values
- ▲ - Temperature rise. The rise of values
- TIMER - ON / OFF function and timer

## Electrical Blinds Control

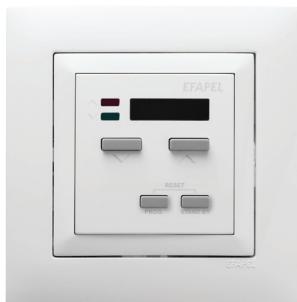

**General Blinds Control Module with Infrared Remote Control**  
(Order code 21311/45311 S)

They allow manually or automatically, the general or individual control of blinds, according to the programmed schedule or the surroundings conditions (luminosity, wind, etc.), measured by associated sensors. Local control of blinds. Possibility to be controlled by the Infrared Remote Control Transmitter for Blinds.

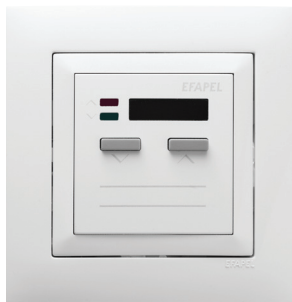

**Local Blinds Control Module with Infrared Remote Control**  
(Order code 21312/45312 S)

Individual control of blinds. Possibility to be controlled by the Infrared Remote Control Transmitter for Blinds Control or by the Infrared Remote Control Transmitter Multifunctions.

Technical parameters	Order code 21311/45311 S	Order code 21312/45312 S
Voltage range:	230 V / 50 Hz	
Consumption:	1 W	
Load capacity:	6 A (1380 W, $\cos \varphi = 1$ )	
Programming:	2 functions (up and down)	—
Backup battery:	24 h	
Function:	Standby	—
Infrared Remote Control Transmitter:	√	

#### • Wiring diagram

Blinds Centralized Installation - With Blinds Control Modules

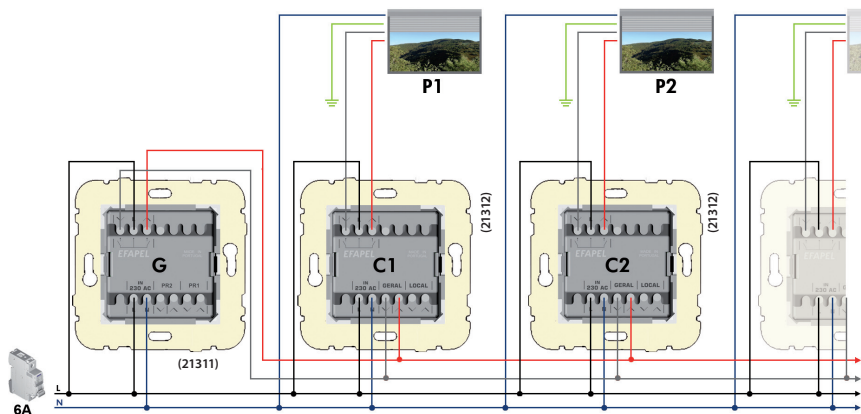

P1, P2 – blinds

G (21311) - main module

C1, C2.. (21312) - local module

#### • Settings (Order code 21311/45311 S)

▼ – Blinds up / down (further) Menu

▲ – Blinds up / Up menu

PROG - Program

PROG + STANDBY - Removing an existing program

STANDBY - Stop the current program

#### General Blinds Control (G)

Terminal

1. General Output - Down
2. Blinds Power Supply (line)
3. General Output - Up
4. Power Supply (line)
5. Power Supply (neutral)
6. Signal input priority 2 (230V~) - Down
7. Signal input priority 2 (230V~) - Up
8. Signal input priority 1 (230V~) - Down
9. Signal input priority 1 (230V~) - Up

#### • Settings (Order code 21312/45312 S)

▼ – Blinds up / down (further) Menu

▲ – Blinds up / Up menu

#### • Local Blinds Control (C1), (C2), ...

Terminal

1. Output for Motor - Down
2. Blinds Power Supply (line)
3. Output for Motor - Up
4. Power Supply (line)
5. Power Supply (neutral)
6. Signal input from General Blinds Control - Down
7. Signal input from General Blinds Control - Up
8. Signal input from the Local Blinds Control - Down
9. Signal input from the Local Blinds Control - Up



Electrical Blinds Control



**Automatic Relay for Blinds Control (Order code 81512)**

Allows to control the individual and general control of a set of blinds.

Can be installed into a standard wall box, in the derivation boxes near the blinds or in deep wall boxes and behind the wiring devices installed in the same box.

Technical parameters	Order code 81512
Voltage range:	230 V / 50 Hz
Consumption:	1 W
Load capacity:	6 A (1380 W, cos φ=1)
Opening and closing time:	90 s
Electrical blockage:	√
Dimensions (H x W x D):	48 x 36.3 x 24 mm

**• Wiring Diagram**

Blinds Centralized Installation - with Automatic relays for blinds control (Ref. 81512)

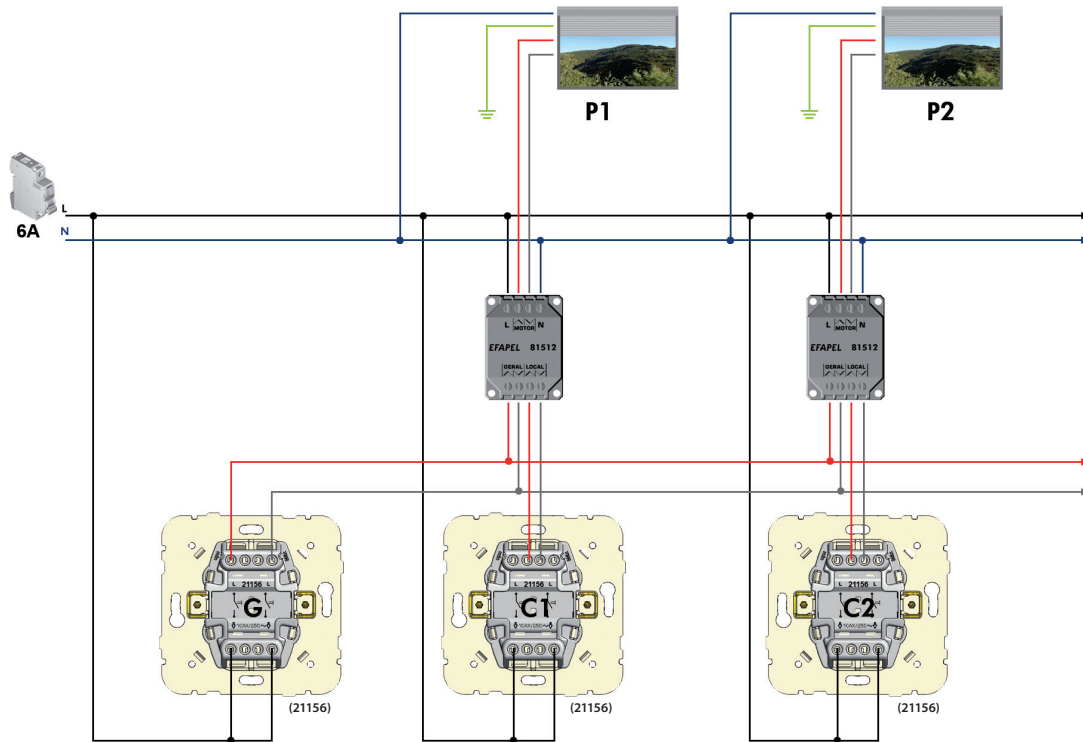

P1, P2 – blinds

G (21156) - main module

C1, C2.. (21156) - local module

Note: The protection against two simultaneous orders of open or close applied in the same device or different devices, is guaranteed by the software of the relay.

**• Automatic Relay for Blinds Control (Ref. 81512)**

Terminal

- ▼ Output for motor - Down
- ▲ Output for motor - Up
- L Phase
- N Neutral
- ▼ Signal input for central control - Down
- ▲ Signal input for central control - Up
- ▼ Signal input for local control - Down
- ▲ Signal input for local control - Up



## Electrical Blinds Control

**Relay for Blinds Control (Order code 81511)**

Allows the individual and general control of a set of blinds.

Can be installed into a standard wall box, in the derivation boxes near the blinds or in deep wall boxes and behind the wiring devices installed in the same box.

Technical parameters	Order code 81511
Voltage range:	230 V / 50 Hz
Consumption:	1 W
Load capacity:	6 A (1380 W, $\cos \varphi = 1$ )
Opening and closing time:	90 s
Electrical blockage:	x*
Dimensions (H x W x D):	48 x 36.3 x 24 mm

\* Electrical blockage: with the Relay for Blinds Control, the electrical blockage (protection against two simultaneous orders) is guaranteed by the association of the Relay for Blinds Control with the Venetian Double Push-button for Multiple Points Blinds Control (Ref. 21283 / 45283 S).

**• Wiring Diagram**

Blinds Centralized Installation - with RELAYS for BLINDS CONTROL (Ref. 81511)

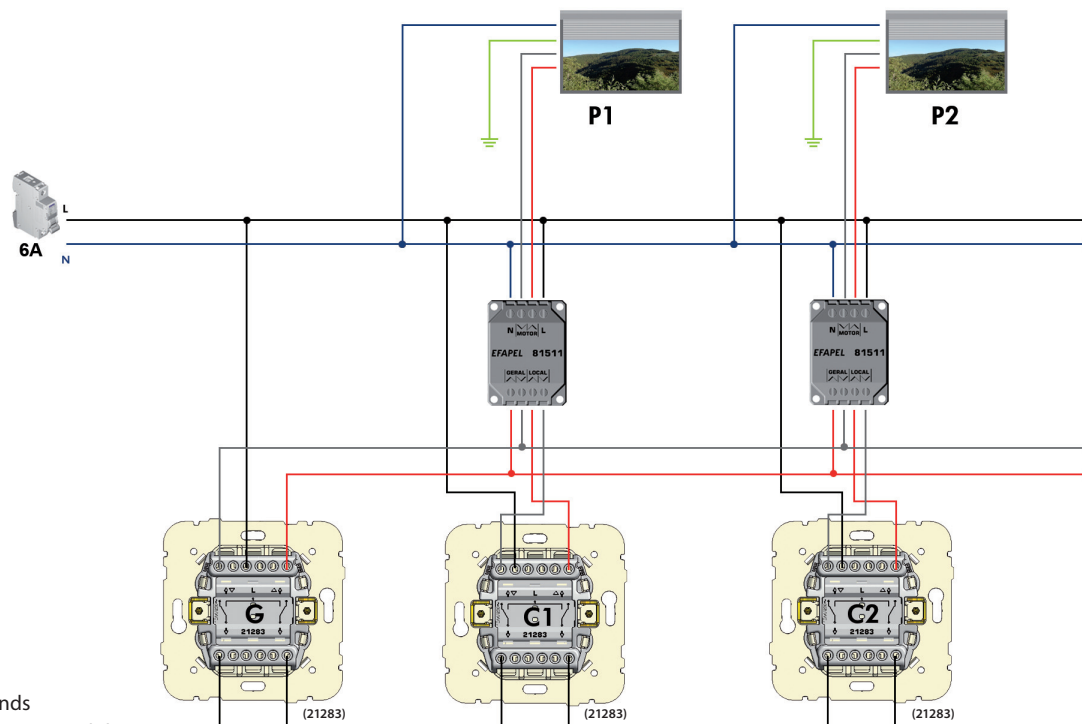

P1, P2 – blinds

G (21283) - main module

C1, C2.. (21283) - local module

Notes: The protection against two simultaneous opening and close orders in the same device or different devices is guaranteed by the combination of the mechanism (Ref. 21283 / 45283 S) and the relay (Ref. 81511). For this reason, this relay works only with the mentioned mechanism.

**• Functions (Order code 81511)**

Terminal

- ▼ Output for motor - Down
- ▲ Output for motor - Up
- L Phase
- N Neutral
- ▼ Signal input for central control - Down
- ▲ Signal input for central control - Up
- ▼ Signal input for local control - Down
- ▲ Signal input for local control - Up

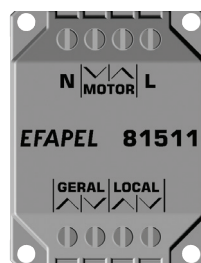

Dimmer



MEC 21 Mechanisms:













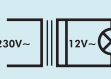
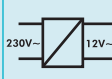





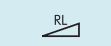



- Finishings - LOGUS<sup>90</sup> | **sirius70** | APOLLO 5000.

Allows to adjust the luminous flux of one or more lamps.

• **Function**

- rotary variation of luminous flux.
- Press button for ON / OFF switching status.

• **Maximum Recommended Loads**

 230V~ 50 Hz	Type	Fuse	Min.	 R	 R	 RL	 RC	 RC	 RC	 RC	 M	
				 Max.	 Max.	 Max.	 Max.	 Max.	 Max.	 Max.	 Max.	
Ref. 21210	-	F0.8A/250V~	-	-	-	-	-	-	-	-	40 mA	-
Ref. 21211		T2A/250V~	20 W/VA	500 W	500 W	500 VA	-	-	-	-	-	-
Ref. 21212		-	5 W/VA	320 W	320 W	-	320 VA	-	-	-	-	-
Ref. 21213		-	20 W/VA	550 W	550 W	-	550 VA	-	-	-	-	-
Ref. 21214		T1A/250V~	7 W/VA 3 W (LED)	110 W	110 W	110 VA	-	110 W	35 W	-	-	-
Ref. 21215		-	15 W/VA 3 W (LED)	150 W	150 W	-	150 VA	150 W	50 W	-	-	-
Ref. 21216		T2A/250V ~	20 W/VA 3 W (LED)	250 W	250 W	250 VA	-	250 W	85 W	-	-	-
Ref. 21217		-	15 W/VA 5 W (LED)	450 W	450 W	-	450 VA	450 W	150 W	-	-	-
Ref. 21219		F2.5A/250V~	20 W/VA	600 W	600 W	-	-	-	-	-	-	600 VA

USB Charger



MEC 21 Serie

USB Socket - 2100 mA - allows you to charge portable devices via a USB socket (mobile phones, smartphones, tablets, powerbanks, MP3, MP4, etc.).

Technical parameters	Order code 21384
Voltage / Frequency:	100~240 V / AC 50~60 Hz
Output voltage:	5 V
Maximum Output Power:	2.4 A
Efficiency:	80 %
Standby power consumption:	< 0.1 W
Output:	2xUSB typu A

## Multimedia Sockets | Radio, Television and Satellite sockets

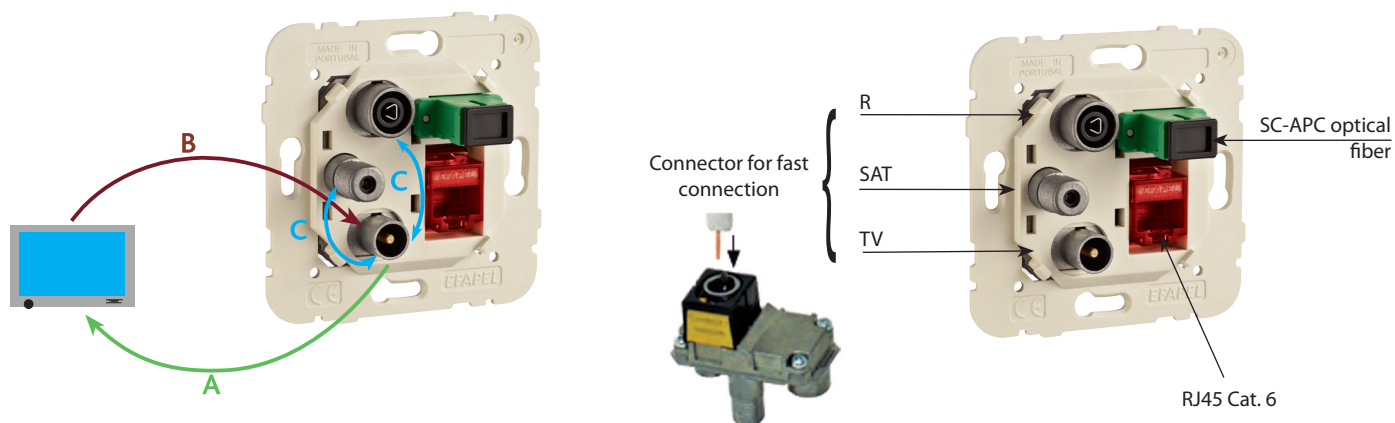

A	Derivation Losses
B	Return Losses
C	Isolation between Outputs

## Sockets Typ

Typology		Order code	RADIO	TV	SAT	FO SC-APC	RJ45 Cat. 6
STAR CONNECTION		Multimedia 21545	☉	⊙	⬠		
		Multimedia 21544	☉	⊙	⬠	-	
		Multimedia 21546	☉	⊙	⬠	-	
		Multimedia 21535	☉	⊙	-		
		Multimedia 21534	☉	⊙	-	-	
		R - TV - SAT 21543	☉	⊙	⬠	-	-
		R - TV 21533	☉	⊙	-	-	-
SERIES CONNECTION		R - TV - SAT 21555	☉	⊙	⬠	-	-
		R - TV 21554	☉	⊙	-	-	-
		R - TV - SAT 21565	☉	⊙	⬠	-	-
		R - TV 21564	☉	⊙	-	-	-

Multimedia Sockets | Radio, Television and Satellite sockets

R - TV - SAT SOCKETS (Impedance of 75 Ohm)

LINEAL	Outputs		Derivation Losses (dB)										Insertion Losses dB	Insulation between Outputs dB	Return Losses dB	DC Current Passage mA (DC)	
	Connector/ Outputs		RETURN	BI	Sub Band	FM	S. Low	BIII /DAB	S. High Hyper	UHF	SAT						
			4-47 MHz	47-68 MHz	68-80 MHz	84-108 MHz	112-174 MHz	174-230 MHz	230-446 MHz	470-862 MHz	950-2150 MHz	2150-2400 MHz					
Order code																	
STAR 21543 21544 21545 21546 45543 S	IEC MALE	TV	<1	<1	<1	<1	<1	<1	<1	<1	<1	--	--	--	>20	>18	--
	IEC FEMALE	R	<20	<20	<20	<20	<20	<20	<20	<20	<20	--	--				--
	F FEMALE	SAT	--	--	--	--	--	--	--	--	<3	<3	(SAT-IN) 500mA				
TERMI- NAL 21555 45555 S	IEC MALE	TV	5 <sup>±1</sup>	5 <sup>±1</sup>	5 <sup>±1</sup>	5 <sup>±1</sup>	5 <sup>±1</sup>	5 <sup>±1</sup>	5 <sup>±1</sup>	5 <sup>±1</sup>	5 <sup>±1</sup>	--	--	--	>12	>18	--
	IEC FEMALE	R	<20	<20	<20	<20	<20	<20	<20	<20	<20	--	--				--
	F FEMALE	SAT	--	--	--	--	--	--	--	--	5 <sup>±1</sup>	5 <sup>±1</sup>	(SAT-IN) 500mA				
CROSSO- VER 21565 45565 S	IEC MALE	TV	9 <sup>±1</sup>	9 <sup>±1</sup>	9 <sup>±1</sup>	9 <sup>±1</sup>	9 <sup>±1</sup>	9 <sup>±1</sup>	9 <sup>±1</sup>	9 <sup>±1</sup>	9 <sup>±1</sup>	--	--	<3	>12	>18	--
	IEC FEMALE	R	18 <sup>±1</sup>	18 <sup>±1</sup>	18 <sup>±1</sup>	18 <sup>±1</sup>	18 <sup>±1</sup>	18 <sup>±1</sup>	18 <sup>±1</sup>	18 <sup>±1</sup>	18 <sup>±1</sup>	--	--				--
	F FEMALE	SAT	--	--	--	--	--	--	--	--	9 <sup>±1</sup>	9 <sup>±1</sup>	(SAT-IN) 500mA				

R - TV SOCKETS (Impedance of 75 Ohm)

EQUALIZED	Outputs		Derivační ztráty (dB)										Insertion Losses dB	Insulation between Outputs dB	Return Losses dB	
	Connector/ Outputs		RETURN	BI	Sub Band	FM	S. Low	BIII /DAB	S. High Hyper	UHF	SAT					
			4-47 MHz	47-68 MHz	68-80 MHz	84-108 MHz	112-174 MHz	174-230 MHz	230-446 MHz	470-862 MHz	950-2150 MHz	2150-2400 MHz				
Order code																
STAR 21533 21534 21535 45533 S	IEC MALE	TV	<1	<1	<1	--	<1	<1	<1	<1	--	--	--	>20	--	
	IEC FEMALE	R	--	--	--	2 <sup>±0.3</sup>	--	--	--	--	--	--				
TERMI- NAL 21554 45554 S	IEC MALE	TV	5 <sup>±1</sup>	5 <sup>±1</sup>	5 <sup>±1</sup>	--	5 <sup>±1</sup>	5 <sup>±1</sup>	5 <sup>±1</sup>	5 <sup>±1</sup>	--	--	--	>20	>18	
	IEC FEMALE	R	--	--	--	6 <sup>±1</sup>	--	--	--	--	--	--				
CROSSO- VER 21564 45564 S	IEC MALE	TV	9 <sup>±1</sup>	9 <sup>±1</sup>	9 <sup>±1</sup>	--	9 <sup>±1</sup>	9 <sup>±1</sup>	9 <sup>±1</sup>	9 <sup>±1</sup>	--	--	1 <sup>±0.5</sup>	>20	>18	
	IEC FEMALE	R	--	--	--	9 <sup>±1</sup>	--	--	--	--	--	--				





# Jazz *Light* series

At home, in the office or in public areas, it gives you a feeling of comfort and well-being...

The **Jazz Light Series** features a variety of components for the Surround Sound application in buildings, offices, apartments, houses and shopping centres.

Thanks to its new central audio modulation units and sound control units, it is possible to simplify the installation and use of the Surround Sound System itself.



The Efel Company **Jazz Light** sound system lets you listen to your favourite music comfortably anywhere in your house and control it according to your needs.

Listen to what you want: you can tune in directly to your favourite radio, or if you prefer your own music selection, you can connect to another source (MP3 player, PC, TV, mobile phone) thanks to the additional input. So you can enjoy your favourite music, movie or live concert on TV, etc. with the best sound quality.

Experience music where you want and want: Enjoy great music, movie or concert in your living room as loud as you really like it!

Production of the new **Jazz Light Series** are part of the LOGUS<sup>90</sup> design series and offer a wide range of options to decorate and customise your area.



Flush Mounting Loudspeakers of 2"				Cover Plates		
	Order code	Box (Un)		Order code	Color	Box (Un)
	Loudspeaker of 2" - 32 Ohm	21581	1		Cover Plate for Loudspeaker of 2" - 32 Ohm	90710 T BR MF GE PE AL IS 2 1



















Flush Mounting Loudspeakers of 5"			
	Loudspeaker of 5" - 32 Ohm for Ceiling Mounting - Mounting Ø diameter: 145 mm - External dimensions: Ø 180 mm - Maximum power: 30W. - Frequency response: 70 - 15000Hz.	75023 C	BR MF 1
	Loudspeaker of 5" - 16 Ohm for Ceiling Mounting - Mounting Ø diameter: 145 mm - External dimensions: Ø 180 mm - Maximum power: : 30W. - Frequency response: 70 - 15000Hz.	75022 C	BR MF 1
	Loudspeaker of 5" - 8 Ohm for Ceiling Mounting - Mounting Ø diameter: 145 mm - External dimensions: Ø 180 mm - Maximum power: 30W. - Frequency response: 70 - 15000Hz.	75021 C	BR MF 1







Surface Mounting Loudspeakers of 5"			
	Surface Mounting Flat 2-Way Loudspeaker of 5" - 32 Ohm - External dimensions (mm): 274 x 185 x 36,5. - Maximum power: 15W. - Frequency response: 80 - 19000Hz.	75106 C	BR 1
	Surface Mounting Flat 2-Way Loudspeaker of 5" - 16 Ohm - External dimensions (mm): 274 x 185 x 36,5. - Maximum power: 15W. - Frequency response: 80 - 19000Hz.	75105 C	BR 1
	Surface Mounting Flat 2-Way Loudspeaker of 5" - 8 Ohm - External dimensions (mm): 274 x 185 x 36,5. - Maximum power: 15W. - Frequency response: 80 - 19000Hz.	75104 C	BR 1



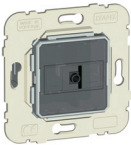

Flush Mounting Loudspeakers of 6,5"			
	Squared Grid 2-Way Loudspeaker of 6,5" - 32 Ohm - External dimensions (mm): 220 x 220 x 93. - Maximum power: 60W. - Frequency response: 60 - 20000Hz.	75083 C	BR MF 1
	Squared Grid 2-Way Loudspeaker of 6,5" - 16 Ohm - External dimensions (mm): 220 x 220 x 93. - Maximum power: 60W. - Frequency response: 60 - 20000Hz.	75082 C	BR MF 1
	Squared Grid 2-Way Loudspeaker of 6,5" - 8 Ohm - External dimensions (mm): 220 x 220 x 93. - Maximum power: 60W. - Frequency response: 60 - 20000Hz.	75081 C	BR MF 1

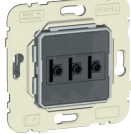
PARAMETER	UNIT	MODEL			
TYPE	Inches	2"	5"	6,5"	5"
INSTALLATION	-	Flush Mounting	Flush Mounting / in ceiling		Surface Mounting
IMPEDANCE	Ohm	32	32 / 16 / 8	32 / 16 / 8	32 / 16 / 8
MAXIMUM POWER	W	10	30	60	15
FREQUENCY RESPONSE	Hz	450 - 5000	70 - 15000	60 - 20000	80 - 19000

Legend: T - Rocker, Cover Plate or Frame. C - Complete devices. Dimensions: H x W x D. BR - White; MF - Ivory; GE - Ice ; PE - Pearl; AL - Aluminium; IS - Gray.

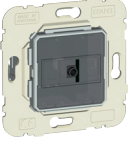
Sound control units				Cover Plates				
		Order code	Box (Un)			Order code	Color	Box (Un)
	1 Mono Channel Sound Control Unit	21371	1		Cover Plate for 1 Mono Channel Sound Control Unit	90700 T	BR MF GE PE AL IS PM DU	2 1
	1 Mono Channel Sound Control Unit with FM Tuner	21373	1		Cover Plate for 1 Mono Channel Sound Control Unit with FM Tuner	90703 T	BR MF GE PE AL IS PM DU	2 1
	Audio-system unit - 4 channel mono	21374	1		Cover plate for audio unit - 4 channel MONO	90704 T	BR MF GE PE AL IS PM DU	2 1
	Audio-system unit - 4 channels FM stereo	21378	1		Cover plate of audio unit - 1 channel FM MONO	90708 T	BR MF GE PE AL IS PM DU	2 1
	1 Stereo Channel Sound Control Unit	21372	1		Cover Plate 1 Stereo Channel Sound Control Unit	90702 T	BR MF GE PE AL IS PM DU	2 1
	1 Stereo Channel Sound Control Unit with FM Tuner	21377	1		Cover Plate for 1 Stereo Channel Sound Control Unit with FM Tuner	90707 T	BR MF GE PE AL IS PM DU	2 1
	1 Stereo Channel Sound Control Unit with FM Tuner and Alarm Clock	21379	1		Cover Plate for 1 Stereo Channel Sound Control Unit with FM Tuner and Alarm Clock	90709 T	BR MF GE PE AL IS PM DU	2 1
	1 Stereo Channel Sound Control Unit with FM Tuner, Alarm Clock and Infrared Remote Control	21370	1		Cover Plate for 1 Stereo Channel Sound Control Unit with FM Tuner, Alarm Clock and Infrared Remote Control	90715 T	BR MF GE PE AL IS PM DU	2 1
	4 Stereo Channels Selector Module (To be used with 1 Stereo Channel Sound Control Unit in installations with Modular Sound Central Units with 3 Stereo Channel Auxiliary Input Module.)	21385	1		Cover plate for audio unit - 4 channel STEREO	90705 T	BR MF GE PE AL IS PM DU	2 1

Modular Sound Central Units			Cover Plates			
	Order code	Box (Un)		Order code	Color	Box (Un)
 <p>1 Stereo Channel Modular Sound Central Unit</p>	21391	1	 <p>Cover Plate for 1 Stereo Channel Modular Sound Central Unit</p>	90851 T	BR MF GE PE AL IS PM DU	1
 <p>1 Stereo Channel Modular Sound Central Unit with FM Tuner</p>	21392	1	 <p>Cover Plate for 1 Stereo Channel Modular Sound Central Unit with FM Tuner</p>	90852 T	BR MF GE PE AL IS PM DU	1
 <p>Three stereo channel auxiliary input module</p>	21393	1	 <p>Cover for auxiliary input module-3 stereo channels</p>	90853 T	BR MF GE PE AL IS PM DU	1

Power supplies			Cover Plates			
 <p>Power Supply Module 15V&lt; ___ &gt;5W - Input: 110/250V~ - 50Hz. - Output: 15V&lt; ___ &gt;5W. - Capacity to supply 1 Mono or Stereo Sound Control Unit.</p>	21380	1	 <p>Cover Plate for Power Supply Module</p>	90670 T	BR MF GE PE AL IS PM DU	1
 <p>Power Supply 15V&lt; ___ &gt;30W for DIN Rail Mounting - Input: 110/250V~ - 50/60Hz. - Output: 15V&lt; ___ &gt;30W. - Capacity to supply 10 Stereo Sound Control Units or 20 Mono Sound Control Units. - Size: 4,5 DIN Modules.</p>					75052	1
 <p>Power Supply 15V&lt; ___ &gt;12W for Installation in Hollow Ceilings - Input: 110/250V~ - 50Hz. - Output: 15V&lt; ___ &gt;12W. - Capacity to supply 4 Stereo Sound Control Units or 8 Mono Sound Control Units. - Possible to mount on the Flush Mounting Deep Ceiling Box for Loudspeaker of 5" and Stereo/Mono Amplifier (Ref. 75984).</p>					75053	1

## Accessories



## Stereo / Mono Amplifier

- Output power: Stereo: 5W + 5W (4 Ohm); Mono: 8W (8 Ohm).
- Rated voltage: 15V < \_\_\_\_ >.
- Function: Stand by.
- Possible to mount on the Flush Mounting Deep Ceiling Box for Loudspeaker of 5" and Stereo/Mono - Amplifier (Ref. 75984).

75032

-

1



## Flush Mounting Ceiling Box for Loudspeaker of 5"

- External dimensions (mm): Ø 165, P=64.

75983

-

10



## Flush Mounting Deep Ceiling Box for Loudspeaker of 5" and Stereo/Mono Amplifier

- External dimensions (mm): Ø 165, P=92.

75984

-

10



## Pre-installation Lid for Loudspeaker of 5"

- External dimensions (mm): Ø 173.
- To be used with Boxes Ref. 75983 and Ref. 75984.

75999 A

BR

2

Remote IR control  
for unit - Order code 21370

75985

-

1



## Flush Mounting Box for Squared Grid 2-Way Loudspeakers

- External dimensions (H x W x D): 227.8 x 227.8 x 119 mm.

75986

-

-

Legend: T - Rocker, Cover Plate or Frame, A - Accessory, BR - White; MF - Ivory; GE - Ice; PE - Pearl; AL - Aluminium; IS - Gray, PM - Black, DU - Gold.





# WATERPROOF 48

## series

EFAPEL with the series **Waterproof 48** is the right choice for "any terrain" when performing an electrical installation in a moist or dusty environment.

Thanks to IP65 protection and use of thermoplastic with high resistance to weather conditions, the **Waterproof 48** series represents the best solution for installations in industrial areas, garages and gardens.

It is produced in the traditional color gray – RAL 7035 – and in white – RAL 9003, which are colors used in EFAPEL technical cable trunkings.

The series **Waterproof 48** has 34 functions; these can be mounted in simple or double bases and in vertical or horizontal positions.

IP65

IK07







16A

## Control Devices





		Order code	Color	Box (Un)
	Single Pole Switch 16AX - 250V~	48011 C	CZ BR	10
	Single Pole Switch with Orienting Light 16AX - 250V~	48012 C	CZ BR	10
	Single Pole Switch with Pilot Lamp 16AX - 250V~	48013 C	CZ BR	10
	Two Circuits Switch IP65, IK07 16AX - 250V~	48061 C	CZ BR	10
	Two-pole Switch IP65, IK07 16AX - 250V~	48021 C	CZ BR	10
	Two-pole Switch with Pilot Lamp 16AX - 250V~	48023 C	CZ BR	10
	Intermediate Switch IP65, IK07 16AX - 250V~	48051 C	CZ BR	10
	Intermediate Switch with Orienting Light IP65, IK07 16AX - 250V~	48052 C	CZ BR	10
	Two-way Switch IP65, IK07 16AX - 250V~	48071 C	CZ BR	10
	Two-way Switch with Orienting Light IP65, IK07 16AX - 250V~	48072 C	CZ BR	10
	Two-way Switch with Pilot Lamp IP65, IK07 16AX - 250V~	48073 C	CZ BR	10
	Double Two-way Switch IP65, IK07 16AX - 250V~	48101 C	CZ BR	10



## Control Devices

		Order code	Color	Box (Un)
	Rocker Push-button IP65, IK07 16A - 250V~	48151 C	CZ BR	10
	Rocker Push-button with Orienting Light - 250V~ IP65, IK07 16A - 250V~	48152 C	CZ BR	10
	Rocker Push-button with Orienting Light - 12V IP65, IK07 6A - 12V	48162 C	CZ BR	10
	Venetian Double Push-button IP65, IK07 16A - 250V~	48281 C	CZ BR	10
	Venetian Double Push-button for multiple points Blinds Control IP65, IK07 16A - 250V~	48283 C	CZ BR	10
	Venetian Switch IP65, IK07 16A - 250V~	48290 C	CZ BR	10

## Energy Sockets

		Order code	Color	Box (Un)
	Safety Earth Socket (French Type) IP65, IK07 16A - 250V~	48112 C	CZ BR	10
	Safety Single Phase Socket IP65, IK07 16A - 250V~	48122 C	CZ BR	10
	Earth Socket (Schuko Type) IP65, IK07 16A - 250V~	48131 C	CZ BR	10
	Safety Earth Socket (Schuko Type) IP65, IK07 16A - 250V~	48132 C	CZ BR	10

## Dimensions (mm)

## INSTRUMENT / SOCKET

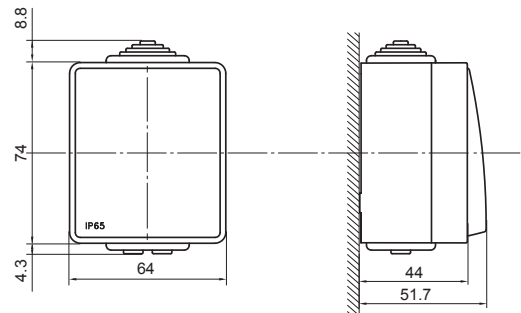
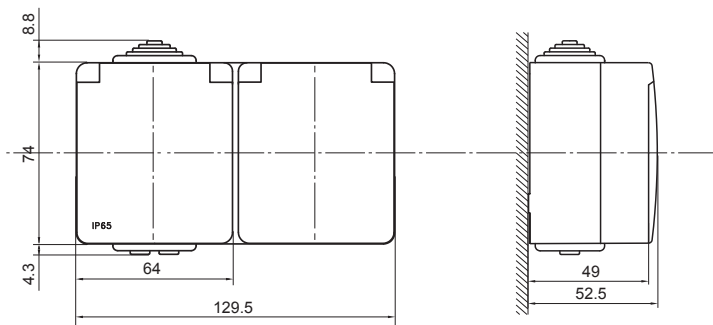
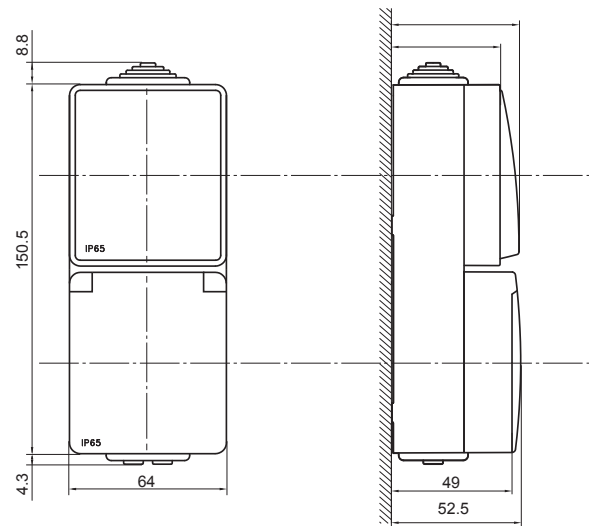
TWO-INSTRUMENT / SOCKET  
- horizontalTWO-INSTRUMENT / SOCKET  
- vertical

# LARA... player in the switch

Radio / Music / Intercom / Videophone / Audiozone



## LARA Radio

- LARA Radio is a music and internet radio player - the size of a circuit breaker, in the LOGUS<sup>90</sup> design (metal, wood, metal ...).
- LARA is used for example in the kitchen, bathrooms, waiting rooms, offices, receptions, entrance halls, operating rooms or wellness areas.
- LARA can play a radio stream and can store as many as 40 in connection with the internet. However, these can be selected from thousands of stations around the world that provide the correct connection data.
- LARA Radio can play the content of an external music source, for example, such as an iPhone, a smart phone, or an MP3 player. These devices are plugged into a 3.5 mm stereo audio jack input that is located at the bottom of the front panel.
- LARA Radio also plays audio files from the central data repository in which the Logitech Media Server is installed. When using with NAS, LARA NAS App is available.
- Operation is done by touching the front panel or infrared remote (included with the product package).
- LARA Radio is equipped with a 1.5" OLED colour display (basic music playback information, setup menu orientation, etc.).
- LARA Radio has an integrated 2x10W amplifier, making it very easy to install the device in areas where the power is sufficient.
- LARA Radio is powered by PoE with a maximum voltage level of 27 V DC / 1000 mA. The advantage is one cable (UTP) for power and communication.

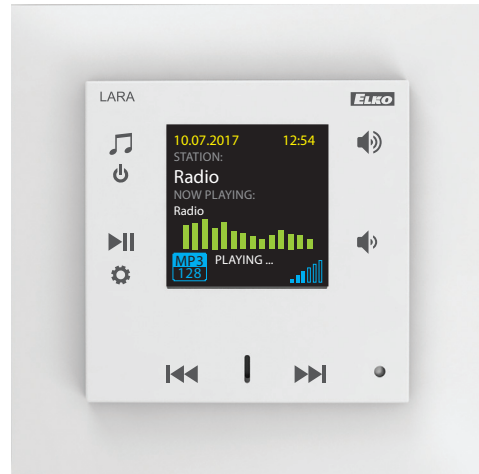

## Intercom & Videophone

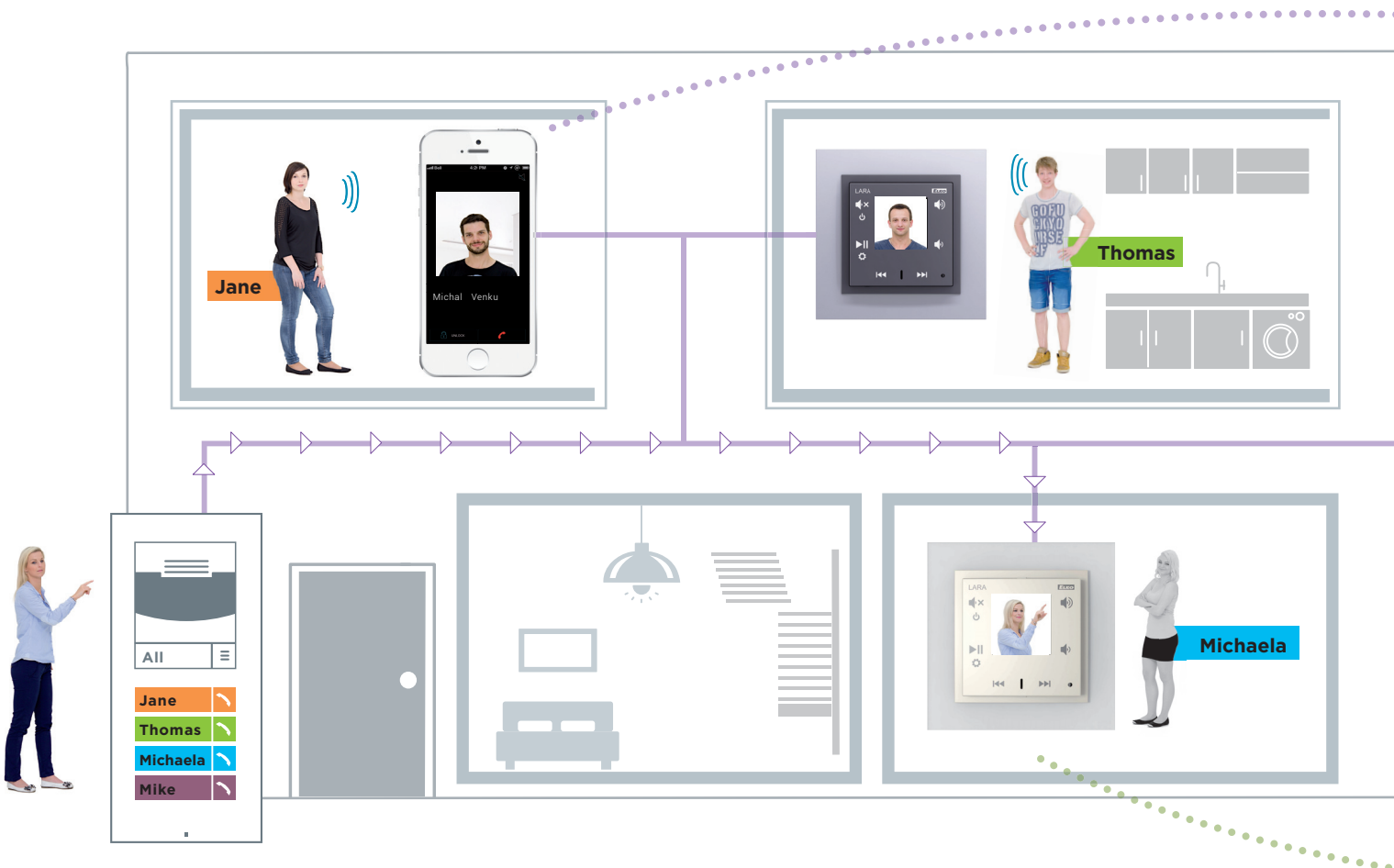

LARA allows you to communicate across the house (Intercom) as well as the door-to-door with the door phone (Videophone).

Up to 30 devices (LARA, phone, tablet ...) can be connected to the system. LARA can communicate with you outside of the house - all you need is an internet connection.



## LARA Intercom

- Not only is LARA your radio and music player, but it is also an INTERCOM, VIDEOTELEPHONE and /or AUDIOZONE.
- LARA Intercom is suitable for installation in both residential and commercial buildings.
- INTERCOM allows bidirectional communication between people in the house, up to 8 LARA devices can communicate directly between them.
- In the case of a 2N IP installation (which has an integrated Asterisk disk), Intercom can be used not only between LARA devices but also among smartphones (with iHC-MA, iHC-MI installed).
- VIDEOTELEPHONE allows you to communicate with 2N and ALPHATECH TECHNOLOGIES (IP BOLD) IP from which LARA transmits picture and sound. If you are not at home, the call is automatically redirected to your smartphone.
- You can connect 6 LARA + 2 IP Phones (or combine them with up to 8 accounts in different ways). Once you have connected a "Connection server," you can use up to 30 LARA devices (combined with IP-speakers) in the installation, which is especially suitable for larger installations (buildings, apartment buildings).
- AUDIOZONE, which allows you to play your music in any area in the house.
- LARA Intercom also plays back audio files from the central data repository in which the Logitech Media Server is installed. This feature of LARA can be used within a comprehensive iNELS system or as a device completely independent of house automation. When used within iNELS, the control is part of a comprehensive iHC application. When using with NAS, LARA NAS App is available.

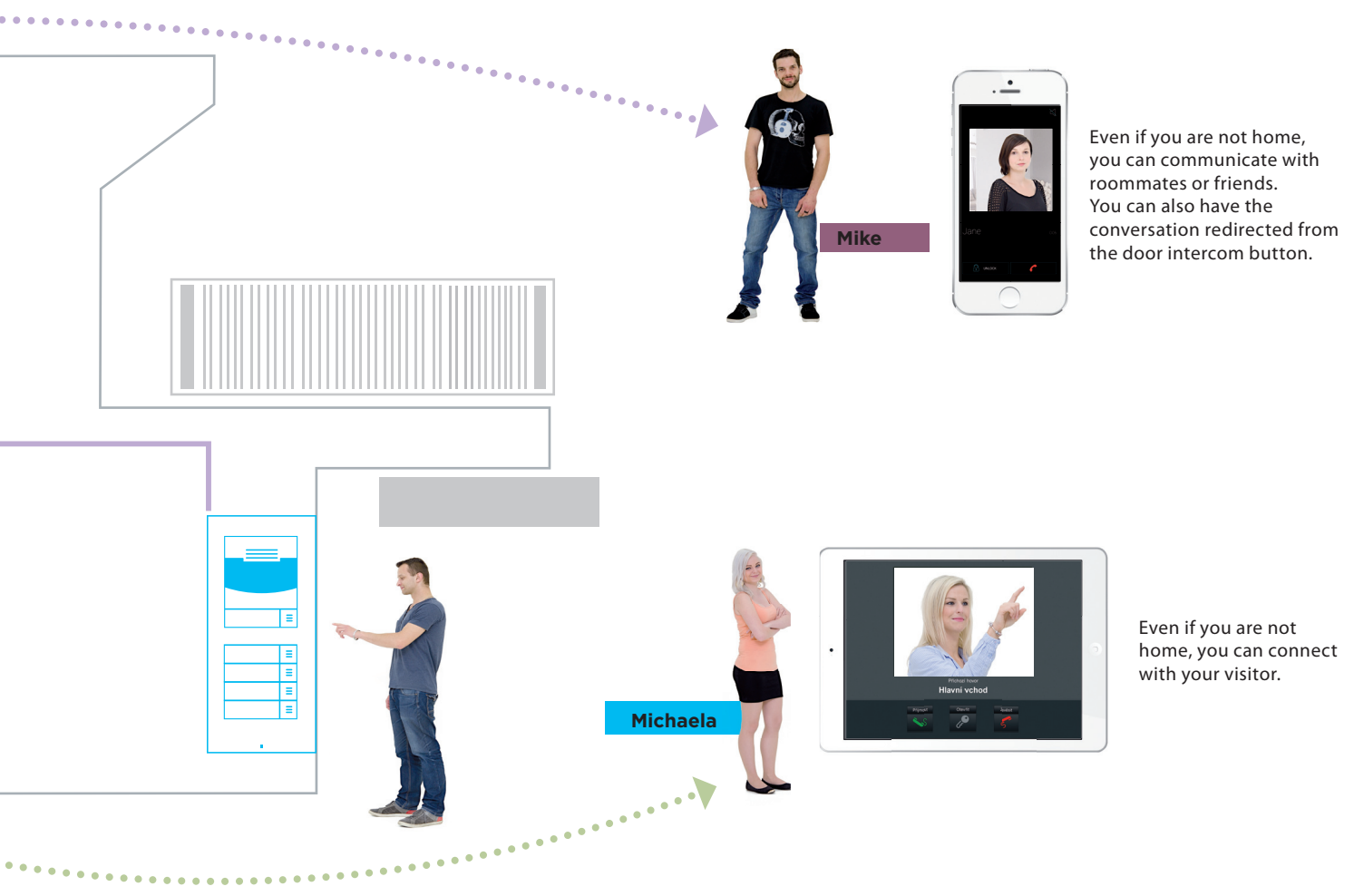
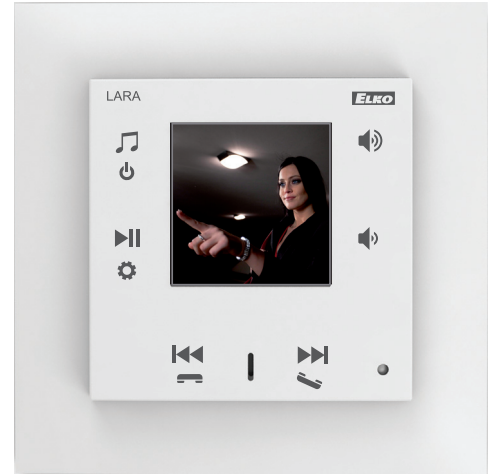

## Installation

### Flush mounting

The LARA device can be installed in an installation box (along with switches), in a design from one to five frames. This installation is recommended in places where at least one installation box is installed or in a place with hollow walls.



### Surface mounting

Surface mounting enables installing the LARA device in places where structural modifications are impossible or difficult to perform. The box is designed for one frame only with selection of installations of external speakers mounted on walls or ceiling.



## Power supply

### Power supply PoE + Wi-Fi into a box

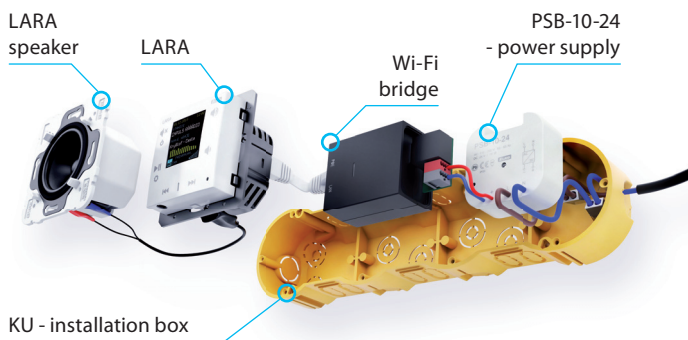

Wi-Fi bridge with PoE and power supply into an installation box.  
Power supply 230V.  
order number: 5224

### Power supply PoE into a box

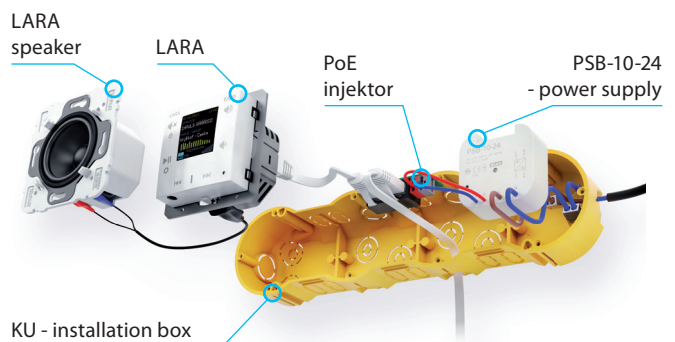

PoE injector with power supply intended for an installation box.  
Power supply 230 V.  
order number: 6605

### PoE supply

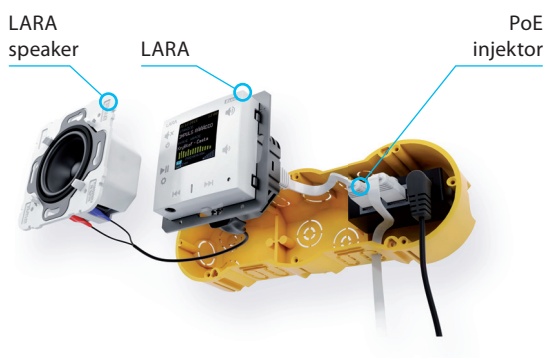

Power injector with plug-in 230V adapter.  
order number: 5225

### Power supply PoE + Wi-Fi

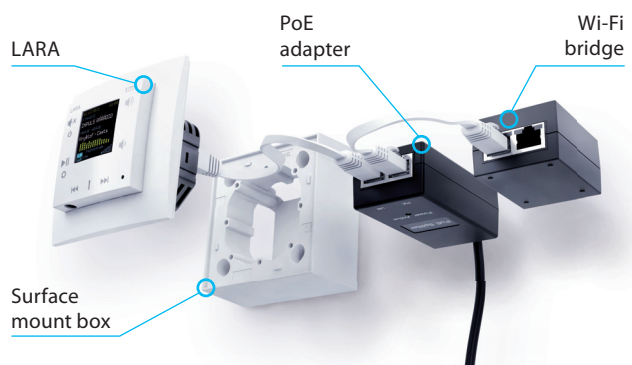

Wi-Fi bridge with PoE plug in 230V adapter.  
order number: 5227



## Speakers

### Flush mounted



dimensions (mm):  
 Ø 52  
 power: 10 W  
 impedance: 32 Ω  
 more color available

### On the wall



dimensions (H x W x D):  
 274 x 185 x 37 mm  
 power: 15 W  
 impedance: 8 Ω, 16 Ω, 32 Ω  
 color: white

### Into a suspended ceiling



dimensions (mm):  
 Ø 180  
 power: 30 W  
 impedance: 8 Ω, 16 Ω, 32 Ω  
 color: white

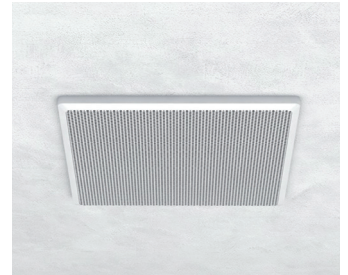

dimensions (H x W x D):  
 220 x 220 x 93 mm  
 power: 60 W  
 impedance: 8 Ω, 16 Ω, 32 Ω  
 color: white

## Door Speakers Compatible Door phone Videophones



Producer: 2N  
 Type: Verso

## Accessories



### AUX CABLE LARA (LARA CINCH CABLE)

5208

Used to connect LARA with exter. amplifier.  
 Reduction 4pin from LARA LINE OUT to 2x  
 CINCH plug into amplifier, length 2x20 cm.



### LARA PoE POWER ADAPTER

6191

PoE power for one LARA.



### LARA SPEAKER CABLE

5209

Patch cable LARA - speaker.



### WIFI BRIDGE

5210

Used for LARA wireless connection via WiFi  
 network.



### AUX CABLE LARA (LARA AUDIO CABLE)

6704

Used to connect LARA with external music  
 source (smartphone, mp3 player). Length 20cm  
 terminated with 2x stereo jack 3.5mm.



### POWER SUPPLY (PSB-10-24)

4378

Switching stabilized power supplies with fixed  
 output voltage, intended for mounting into  
 an installation box (e.g. KU-68). PSB-10-24 -  
 stabilized power supply 24V/10 W.



### PoE SWITCH

6605

Provides LAN connectivity and PoE power supply  
 for up to 5 x LARA. Power supply AC 230 V.



### NAS EXTERNAL STORAGE

7212

Two-chamber NAS server with the function of  
 hosting, sharing and data security.

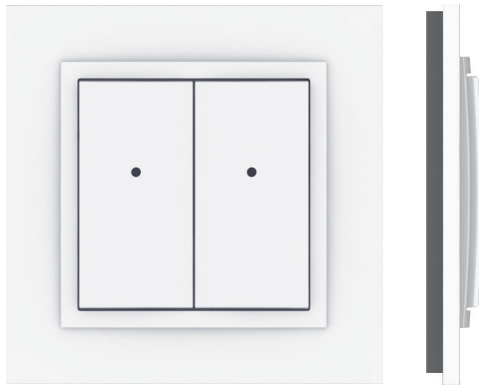

- The wireless controller is used to control switches and dimmers (lights, gate, garage door, blinds, etc.).
- **RFWB-20/G**: two buttons enable control of two units independently.
- **RFWB-40/G**: four buttons enable control of four units independently.
- The flat design with level base makes it ideal for fast installation on any surface (fixation with adhesive or screws in the installation box).
- When pressing the button, it sends a set signal (ON/OFF, dimming, time switching OFF / ON, blinds up/down).
- Sending a command is indicated by a red LED.
- In LOGUS<sup>90</sup> switch frame design (plastic, glass, wood, metal, stone).
- Option of setting light scenes, where with a single press, you can control units of iNELS RF Control.
- Battery power supply (3 V / CR2032 - included in the supply) with battery life of around 5 years based on frequency of use.
- Range up to 200 m (in open space), if the signal is insufficient between the controller and unit, use the signal repeater RFRP-20 or protocol component RFIO<sup>2</sup> that support this feature.
- Communication frequency with bidirectional protocol iNELS RF Control.

### Device description

RFWB-20/G

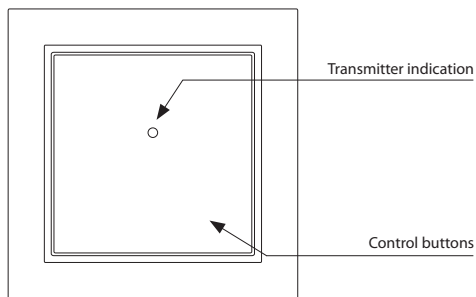

RFWB-40/G

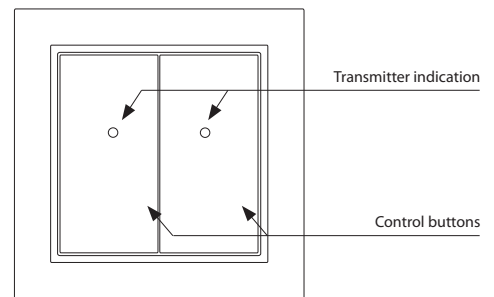

### Examples of placement

RFS-61B  
RFSC-61

## LOGUS<sup>90</sup>

We bring you switches, sockets and accessories in standard, plastic or metallic design, but you will be impressed most by enchanting luxury design of purely natural frames: real wood, metal, granite and tempered glass - crystal

On wall

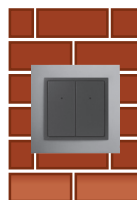

On wood

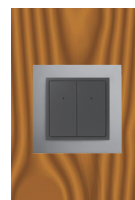

On glass

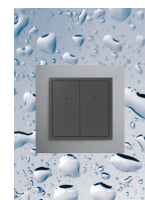

Plastic



Metallic plastic



Color plastic



Color plastic



Metal



Wood



Stone



Crystal



- The wireless controller in design LOGUS<sup>90</sup> measures the room temperature by internal sensor, and based on the set temperature, it sends a command for heating / cooling.
- Option of setting a daily/weekly automatic control program.
- The temperature controller can be used in one of two ways:
  - For controlling an additional heat source (heater, oil radiator, radiant panel) with multi-function switching units RFSA-6x, RFUS-61 or RFSC-61.
  - For control of floor heating, when the internal sensor scans the room temperature, and based on the value, controls the heating unit RFSTI-11B, which monitors the critical floor value by external sensor.
- Manual control by buttons on the unit.
- Range of measured temperature 0-55 °C.
- The backlit LCD display displays the current and set temperature, status (ON/OFF), battery status, day of the week, current time, etc.
- Battery power (1.5 V / 2x AAA - included in supply) with battery life of around 1 year based on frequency of use.
- The flat rear side of the device enables its placement anywhere in the room where you wish to measure temperature.
- Range up to 100 m (in open space), if the signal is insufficient between the controller and unit, use the signal repeater RFRP-20 or protocol component RFIO<sup>2</sup> that support this feature.
- Communication frequency with bidirectional protocol iNELS RF Control.
- Color combination of temperature unit in design of frames LOGUS<sup>90</sup> (plastic, glass, wood, metal, stone).

Device description

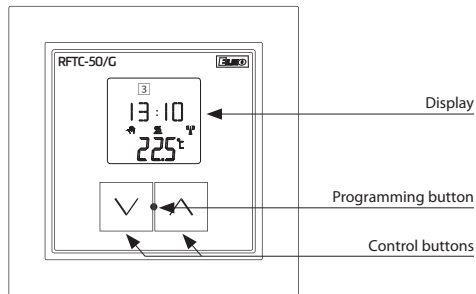

Display description

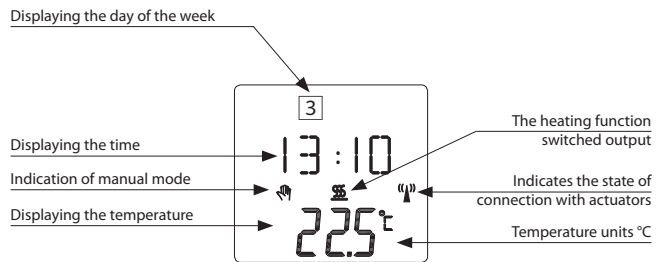

Example of connection



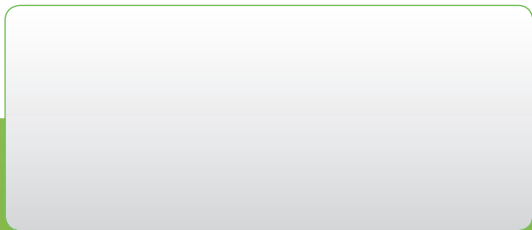
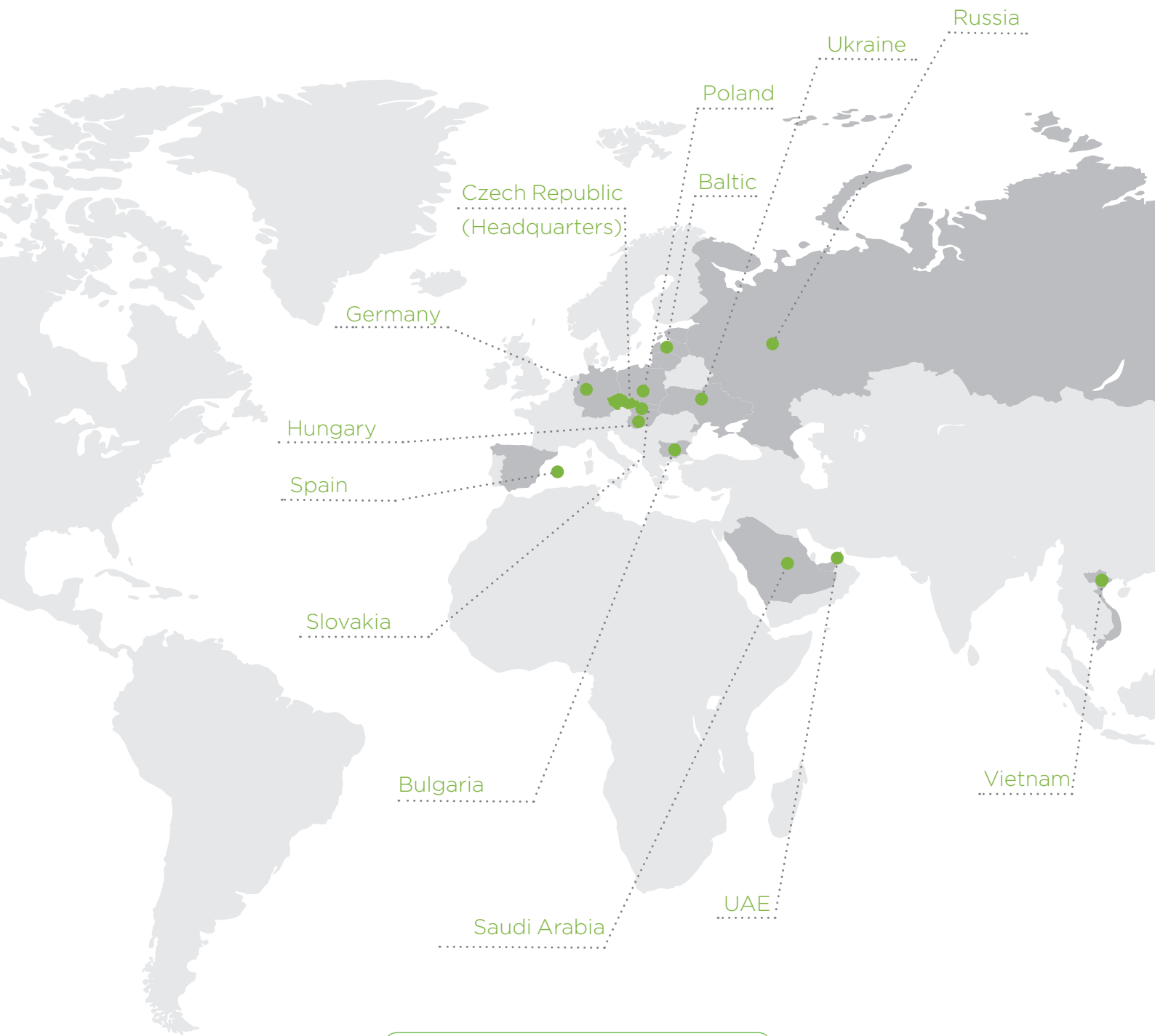

**ELKO EP, s.r.o.**

Palackeho 493 | 769 01 Holesov, Vsetuly | Czech Republic  
phone: +420 573 514 221 | fax: +420 573 514 227 | elko@elkoep.com | www.elkoep.com

Published: 01/2020 | Modifications or amendments reserved | © Copyright ELKO EP, s.r.o. | 1st edition