

WIRED (BUS) ELECTRO-INSTALLATION



ELKO EP



We are traditional, innovative and purely Czech development manufacturer of electronic devices and we have been your partner in the field of electroinstallations for 26 years.

ELKO EP employs about 330 people, exports its products to more than seventy countries, and has representatives in thirteen foreign branches. Company of the Year of the Zlín Region, Visionary of the Year, Global Exporter of the Year, Participation in the Czech TOP 100, these are just some of the awards received. Still, we are not finished. We are constantly striving to move forward in the field of innovation and development. That's our primary concern.

Millions of relays, thousands of satisfied customers, hundreds of our own employees, twenty six years of research, development and production, thirteen foreign branches, one company. ELKO EP, innovative- a purely Czech company based in Holešov, where development, production, logistics, service and support go hand in hand. We primarily focus on developing and manufacturing systems for building automation in the residential, commercial and industrial sector, a wide range of Smart city facilities and the so-called Internet of Things (IoT).



Facts and stats

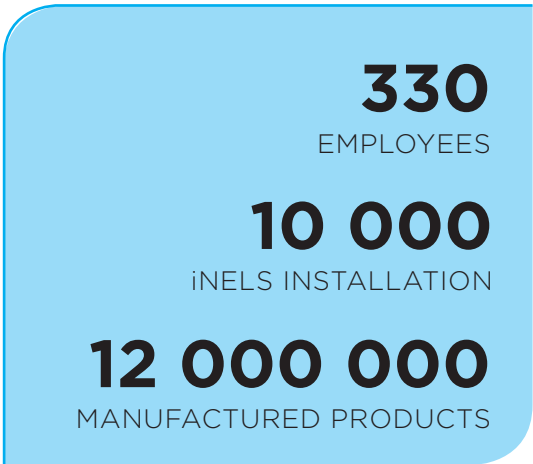
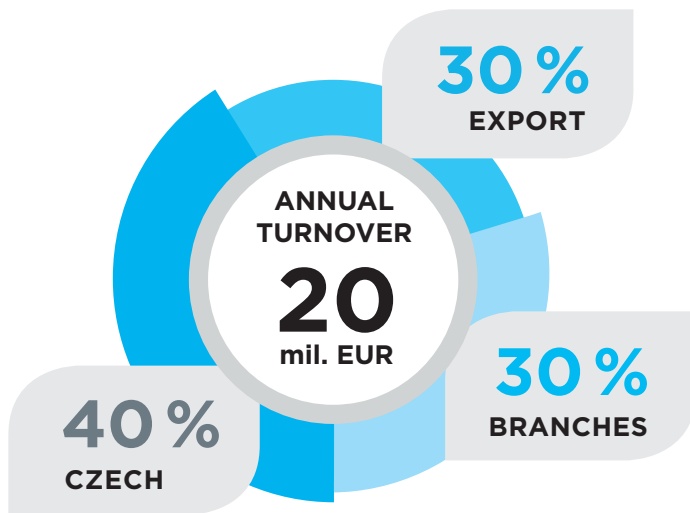

WE ARE



DEVELOPERS

In the new R&D center, more than 30 engineers develop new products and extend the functionality of existing products

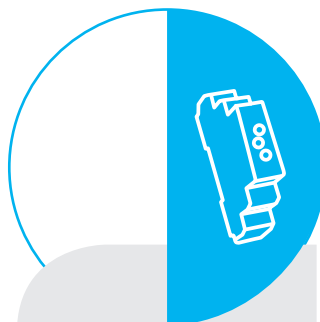

PRODUCERS

modern antistatic spaces, 2x fully automated SMD production lines, 2 shift operations.



SUPPORT

24 hours / 7 days / 360 days we not only provide technical support but also logistics.



SELLERS

personal access to more than 70 sales representatives in ELKO EP Holding provides impeccable services and superior products at an affordable price.

WIRELESS ELECTRICAL INSTALLATIONS

If you are going to renovate the house but, you do not want to interfere with the existing wiring, take advantage of our wireless solutions. The communication between the components works wirelessly at 868-916 MHz, using our unique RFIO and RFIO² protocols. Both are proprietary ELKO EP wireless protocols, which have a completely unique structure.

The advantage of this system, compared to the bus solution, is the possibility of gradually extending and adding individual components to the electrical installation. You can easily control lighting, heating, switching appliances and shading techniques, or have everything secured by detectors. Variable control brings countless possibilities - from key fobs to flat panel controllers on the wall that can be placed anywhere, to the application on your smartphone.

BUS ELECTRICAL INSTALLATIONS

Are you building a new house? Then you should consider a BUS-based solution. A BUS in this sense is a data conductor that is distributed in the walls across the entire home. As opposed to a wireless solution, its advantage is range, because up to 18 x 550 m BUSes can be distributed in a single building.

Connection to a computer expands the scope of its available functions. This system may be expanded to include multimedia extensions and can connect third party devices (household appliances, A/C, etc.). Control and monitoring the system can be performed via PC, the Internet, telephone, tablet, etc. The system offers a wider range of applicable functions. A computer is used to set the parameters.

Supported technologies

- ✗ Control using the TV
- ✓ Tablet
- ✓ PC / Laptop
- ✗ Music playback
- ✓ Video cameras
- ✓ Weather station
- ✓ Door communicator
- ✗ Controlling home appliances
- ✓ Touch panel
- ✓ Control via Smartphone
- ✓ Detectors
- ✓ Wireless switch
- ✓ Heating regulation
- ✓ Controlling blinds
- ✓ Dimming lights
- ✓ Controlling appliances

Supported technologies

- ✓ Control using the TV
- ✓ Tablet
- ✓ PC / Laptop
- ✓ Music playback
- ✓ Video cameras
- ✓ Weather station
- ✓ Door communicator
- ✓ Controlling home appliances
- ✓ Touch panel
- ✓ Control via Smartphone
- ✓ Detectors
- ✓ Wireless switch
- ✓ Heating regulation
- ✓ Controlling blinds
- ✓ Dimming lights
- ✓ Controlling appliances

Price of installation:

Energy savings:

Price of installation:

Energy savings:

<p>Controlling appliances</p>	<p>Dimming lights</p>	<p>Controlling blinds</p>	<p>Heating regulation</p>	<p>Group controller</p>	<p>Detectors</p>	<p>Smartphone Smart watches</p>	<p>Touch panel</p>
<p>Controlling household appliances</p>	<p>Door communicator</p>	<p>Weather station</p>	<p>Video cameras (outdoor/indoor)</p>	<p>Audio Zone (music playback)</p>	<p>PC /Laptop</p>	<p>Tablet</p>	<p>Video Zone (controlling via TV)</p>

The BUS electro installation iNELS BUS System is a unique solution for electrical installation in the implementation of new projects of houses, villas, apartment buildings, office buildings, hotels, restaurants, wellness centres or perhaps even warehouse or production hall.

The ability to deploy this solution in such a wide variety of different buildings with various purposes and uses lies in its modularity. Thanks to the modular design, the system is very flexible and allows on the one hand, a solution of single-purpose tasks such as control of lighting in restaurants, and on the other hand, solving complex control systems for heating, ventilation, cooling, lighting and shading of office buildings. A complete range of control units designed from glass for management of hotel rooms is in the market unique.

Thanks to its modularity is very easy to customize the size of the system and to that effect create a cost effective solution.

Smart homes and buildings are accompanied by three basic ideas, namely savings, comfort and safety, the first two ideas may at first glance contradict each other. However, the main objective of smart home or building equipped with the iNELS solution is to attain the optimum indoor environment while achieving the most efficient operation of all system.

In homes and buildings the optimal internal environment is very important because people nowadays spend up to 80% of their time inside buildings. It is also shown that indoor environments, where we talk about thermal comfort, lighting comfort and indoor air quality significantly affect the mood and the effectiveness of people.

The iNELS system allows connection of wide range of sensors (temperature, light intensity, carbon dioxide, humidity, and pressure) and detectors (movement, opening doors and windows, gas leakage, smoke, flooding) whose values are constantly evaluated. At the same time iNELS allows the connection of all the technologies that are installed in the building, which continued to significantly increase operational efficiency or comfort, for example; in the case of integrating the guest room management system with the receptionist Fidelio system, which automatically during check-in, sends the room requests for execution, a welcome scene (optimum temperature, comfortable lighting scene, music etc.).

What are the benefits of BUS controlling?

- Save energy by regulating lighting and heating properly
- Control of blinds, awnings, exterior or internal window shutters
- Dimming lights, lighting scenes
- control of appliances or electrical devices
- Control access gates, garage doors
- Logical and central functions (exit button, ...)
- Manual and automatic control mode
- Preventing undesirable opening of a window or a door
- Responding to the movement of people (authorized and unauthorized)
- Remote monitoring via smartphone, tablet or laptop
- Possibility to control via the iNELS Touch Panel 10"
- Integration of third-party devices (cameras, air conditioning, ...)



More systems can be controlled by iNELS:

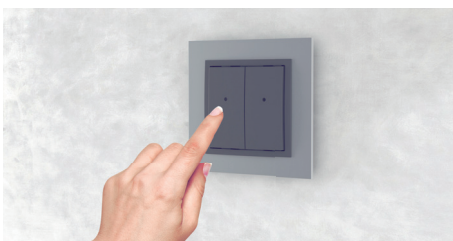

Wall controller



Keychain



Remote control

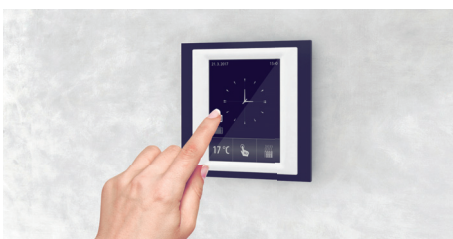

Touch panel



Smartphone



iTP – iNELS Touch panel

Intelligent Electro-installation

Overview of system units	8
Wired electro-installations	
CU3-01M, CU3-02M Central unit	14
CU3-03M Central unit	15
PS3-100/iNELS Power supply	18
MI3-02M External master BUS	20
MI3-02M/ETH External master BUS with Ethernet communication	21
BPS3-01M, BPS3-02M BUS separator from power supply	22
GSM3-01M GSM communicator	23
SA3-02M Switching Actuator, 2-channel	24
SA3-04M Switching Actuator, 4-channel	25
SA3-06M Switching Actuator, 6-channel	26
SA3-012M Switching Actuator, 12-channel	27
SA3-022M Switching Actuator, 22-channel	28
EA3-022M Switching Actuator, 22-channel	29
SA3-01B, SA3-02B Switching Actuators, 1-channel and 2-channel	30
JA3-02B/DC Shutter Actuator	31
JA3-018M Shutter Actuator, 18-channel	32
DA3-22M Universal dimming actuator, 2-channel	33
DA3-06M Dimmer Actuator, 6-channel	34
LBC3-02M Dimming actuator for electronic ballasts, 2-channel	35
RFDA-73M/RGB Dimming actuator for LED (RGB) strips, 3-channel	36
DCDA-33M Dimming actuator for LED sources, 3-channel	38
IM3-140M Binary input unit, 14-channel	39
IM3-20B, IM3-40B, IM3-80B Binary input units	40
TI3-10B, TI3-40B Temperature input, 1-channel and 4-channel	42
TI3-60M Temperature input, 6-channel	43
ADC3-60M Analog-digital converter	44
DAC3-04M Digital-analog converter	45
DAC3-04B Digital-analog converter	46
FA3-612M Fan Coil Control Actuator	47
EST3 Elko smart touch screen	48
GSB3-40, GSB3-60, GSB3-80 Glass switch button	50
WSB3-20, WSB3-20H Wall switch button	52
WSB3-40, WSB3-40H Wall switch button	53
WMR3-21 Wall card reader	54
GMR3-61 Glass wall card reader	55
IDRT3-1 Digital room thermo-regulator	56

Lighting control

EMDC-64M | Gateway iNELS - DALI/DMX 58
 DMD3-1 | Combined detector 59
 DLS3-1 | Luminescence sensor 60

Hospitality Solution

CU3-04M | Central unit 62
 GCR3-11 | Glass card reader 64
 GDB3-10 | Glass door bell 65
 GCH3-31 | Glass card holder 66
 EHT3 | Elko Hotel Touch screen 67
 GRT3-50 | Glass room thermo-regulator 68
 GBP3-60 | Glass bedside panel 69
 GBP3-60 | Accessories 70
 GSB3-20/S, GSB3-40/S, GSB3-60/S | Glass switch button with symbols 72
 GSP3-100 | Glass switch panel 74

Building Management System

iNELS Niagara 76

Multimedia

iTP 10" | iNELS Touch Panel 10" 81
 Connection Server 82
 iMM Audio Zone-R 83
 eLAN-IR-003 84
 eLAN-RS485/232 85
 LARA Radio 86
 LARA Intercom 87
 Accessories LARA 89

Application iNELS Home Control

iHC 90

Accessories iNELS

TELVA 230 V, TELVA 24 V | Thermo drive 92
 AN-I, AN-E | Antenna 92
 TC, TZ, Pt100 | Thermo sensors 93

Loadability of contacts 94
 Installation possibilities 96
 Dimensions 98

System units



CU3-01M
Central unit



CU3-02M
Central unit



CU3-03M
Central unit



PS3-100/iNELS
Power supply

Switching actuators



SA3-02M
Switching actuator,
2-channel



SA3-04M
Switching actuator,
4-channel



SA3-06M
Switching actuator,
6-channel



SA3-012M
Switching actuator,
12-channel

Dimming actuators



JA3-02B/DC
Shutter actuator



JA3-018M
Shutter Actuator,
18-channel



DA3-22M
Universal dimming actuator,
2-channel

Converters



ADC3-60M
Analog-digital converter



DAC3-04M
Digital-analog converter



DAC3-04B
Digital-analog converter



FA3-612M
Fan Coil Control Actuator

Input units



IM3-20B
Binary input units



IM3-40B
Binary input units



IM3-80B
Binary input units



IM3-140M
Binary input unit,
14-channel



MI3-02M
External master



MI3-02M/ETH
External master BUS with Ethernet communication



BPS3-01M
BPS3-02M
BUS separator from power supply



GSM3-01M
GSM communicator

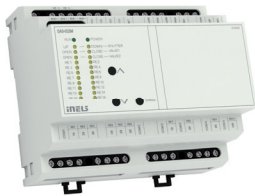

SA3-022M
Switching Actuator, 22-channel



EA3-022M
Switching Actuator, 22-channel



SA3-01B
Switching actuator, 1-channel



SA3-02B
Switching actuator, 2-channel

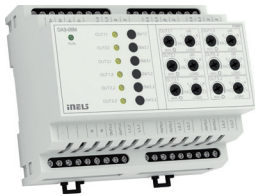

DA3-06M
Dimmer Actuator, 6-channel



LBC3-02M
Dimming actuator for electronic ballasts, 2-channel



DCDA-33M
Dimming actuator for LED sources, 3-channel



RFDA-73M/RGB
Dimming actuator for LED (RGB) strips, 3-channel

Lighting control



EMDC-64M
Gateway iNELS - DALI/DMX



DMD3-1
Combined motion and light intensity detector



DLS3-1
Luminescence sensor



TI3-10B
Temperature input, 1-channel



TI3-40B
Temperature input, 4-channel



TI3-60M
Temperature input, 6-channel

Wall units and controllers



EST3
Elko smart touch screen

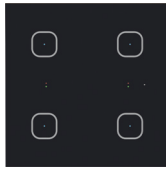

GSB3-40
Glass switch button

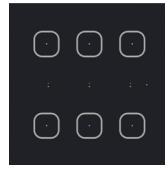

GSB3-60
Glass switch button

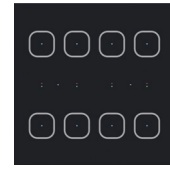

GSB3-80
Glass switch button



IDRT3-1
Digital room thermo-regulator

Hotel solutions

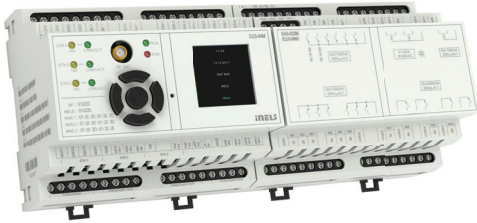

CU3-04M
Central unit

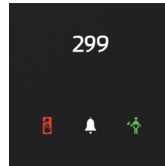

GCR3-11
Glass card reader

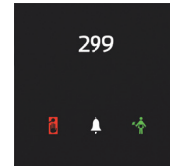

GDB3-10
Glass door bell

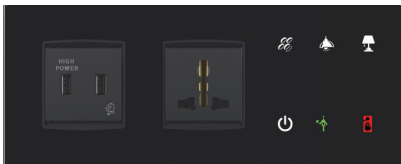

GBP3-60L/2F
Glass bedside panel, left

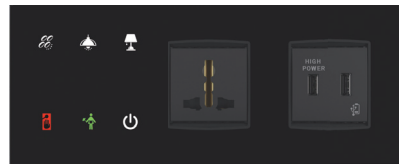

GBP3-60R/2F
Glass bedside panel, right

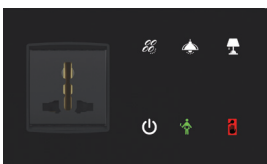

GBP3-60L/1F
Glass bedside panel, left

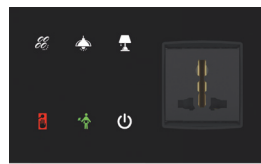

GBP3-60R/1F
Glass bedside panel, right

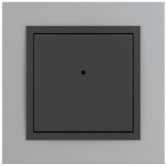

WSB3-20
WSB3-20H
Wall switch button

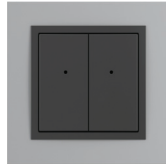

WSB3-40
WSB3-40H
Wall switch button

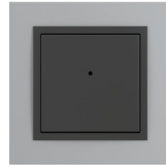

WMR3-21
Wall card reader

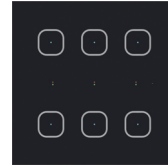

GMR3-61
Glass wall card reader

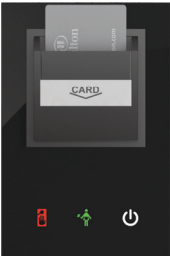

GCH3-31
Glass card holder



EHT3
Elko Hotel Touch screen

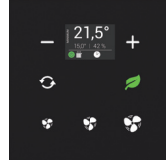

GRT3-50
Glass room thermo-regulator

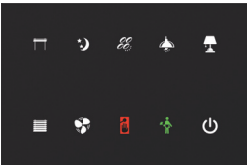

GSP3-100
Glass switch panel

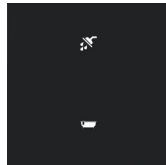

GSB3-20/S
Glass switch button with symbols

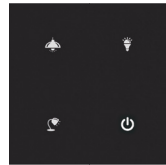

GSB3-40/S
Glass switch button with symbols

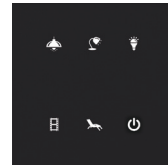

GSB3-60/S
Glass switch button with symbols

Multimedia



iTP 10"
iNELS Touch Panel 10"

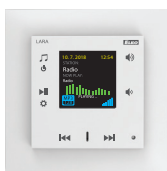

LARA Radio
Internet radio player

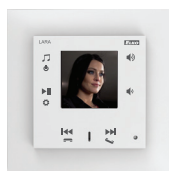

LARA Intercom
Multifunctional
communications devices



Connection Server
Server for integration of
third parties



iMM Audio Zone-R
Audio zone player



eLAN-IR-003
Ethernet-IR transmitter



eLAN-RS485/232
Converter RS485/232-iNELS

iNELS Home Control application



iHC-MI
Application for iPhones



iHC-MA
Application for Android phones



iHC-TI
Application for iPads



iHC-TA
Application for Android tablets

Accessories



TELVA 230V
TELVA 24V
Thermodrives



AN-I
AN-E
Internal antenna
External antenna



TC
TZ
Pt100
Thermo sensors

Wired electro-installations

Smart home & building solutions



www.inels.com

INELS[®]



EAN code
 CU3-01M: 8595188132220
 CU3-02M: 8595188132398

Technical parameters CU3-01M, CU3-02M

LED Indication

Green LED RUN:	Flashing - communication with BUS, ON - no communication
Red LED ERR:	Flashing - no project, ON - unit STOP

OLED display

displays the current status and settings

Type:	color OLED
Resolution:	128x128 / 1:1 aspect ratio
Visible area:	26x26 mm
Controlling:	using arrows
The internal real-time clock:	accuracy: 1s/day at 23 °C

Inputs

Inputs:	4x NO or NC to GND (-) 2x analogue inputs 0÷30
---------	---

Outputs

Output:	relay output- NO/GND
Number of connected units (directly to the CU3-01M (02M):	max. 64 (2x32)
Expansion possibilities external BUS master:	up to 576 units (CU3-01M (02M) and 8x MI3-02M)

Communication

BUS	
Maximum number of units:	max. 32 units to one BUS line
Maximum cable length:	max. 500 m (depends on power loss)
System BUS EBM	
Maximum cable length:	max. 500 m
Number of connected ext. masters:	up to 8 (regards to increasing the cycle turns)
Ethernet	
Connector:	RJ45 on the front panel
Communication speed:	100 Mbps
Indication of the Ethernet:	green - Ethernet communication yellow - Ethernet speed 100 Mbps
The default IP address:	192.168.1.1 (the IP address can be changed in the menu using the display and buttons)

Power supply

Supply voltage / tolerance:	27 V DC, -20 / +10 %
Dissipated power:	max. 3 W
Rated current:	110 mA (at 27V DC)

Operating conditions

Working temperature:	-20 to +55 °C
Storage temperature:	-25 to +70 °C
Humidity:	max. 80%
Degree of protection:	IP20 devices, IP40 with cover in the switchboard
Overvoltage category:	II.
Degree of pollution:	2
Operating position:	any
Installation:	to the switching board on the EN60715 DIN rail
Design:	6-MODULE
Terminal:	max. 2.5 mm ²

Dimensions and weight

Dimensions:	90 x 105 x 65 mm	
Weights:	288 g	291 g

- CU3-01M and CU3-02M are central units' of the iNELS system and mediators, between user software interface and controllers, units and actuators connected to the BUS.
- It's possible to directly connect up to 2 lines of BUSes in to CU3-01M and CU3-02M, and on each BUS we can connect up to 32 iNELS3 units.
- The main difference between CU3-02M and CU3-01M is that CU3-02M is moreover equipped by RF module which enables communication with selected units from iNELS RF Control system.
- User's project and retentive data are stored in a non-volatile internal memory hereby data are backed up without the supply voltage. Real time clock (RTC) backup for 10 days.
- Power supply controlling system - network voltage and the status of the backup battery.
- Possibility of setting time synchronization via NTP server.
- The RJ45 Ethernet port's connector is located on the front panel of the unit, the transmission speed is 100 Mbps.
- For CU3-01M (02M) it is possible to use 4 potential-free inputs for connecting external controllers (buttons, switches, sensors, detectors, etc.) and 2 analog inputs 0 - 30V.
- CU3-01M (02M) comes with OLED display that shows the current status and enables settings (network settings, date, time, service) of the central unit CU3-01M (02M).
- Movement in the menu CU3-01M (02M) using arrows on the front panel.
- CU3-01M (02M) in 6-MODULE are designed for mounting into a switchboard on the EN60715 DIN rail.

iNELS RF Control interface for CU3-02M

Communication protocol:	RF Touch Compatible
Transmitting frequency:	866 MHz / 868 MHz / 916 MHz
Signal transmission methods:	bidirectionally addressed message
Output for RF antenna:	SMA connector*
RF antenna:	1 dB (part of package)
Free space range:	up to 100 m

* Max Tightening Torque for antenna connector is 0.56 Nm.



EAN code
CU3-03M: 8595188132404

Technical parameters		CU3-03M
LED Indication		
Green LED RUN:	Indication of the operating state of the unit	
Red LED ERR:	Unit error indication	
TFT display		
displays the current status and settings		
Type:	color TFT	
Resolution:	240x240 / 1:1 aspect ratio	
Visible area:	26x26 mm	
Controlling:	using arrows	
The internal real-time clock:	accuracy: 1s/day at 23 °C	
Inputs		
Inputs:	8x DIN GS 12-230V AC / DC (over common COM terminal)	
	4x DIN voltage or current (with adjustable switching in current mode)	
	7x AIN / DIN voltage or current (with adjustable switching in current mode)	
Communication		
BUS		
Maximum number of units:	max. 32 units to one BUS line	
Maximum cable length:	max. 500 m (depends on power loss)	
3x Ethernet		
Connector:	RJ45 on the underside of the product	
Communication speed:	100 Mbps	
Indication of the Ethernet:	3x green - Ethernet communication 3x yellow - Ethernet speed 100 Mbps	
The default IP address (ETH3):	192.168.1.1 (the IP address can be changed in the menu using the display and buttons)	
DALI master:	up to 64 master units, max. 64 slave units	
Maximum number of units:	max. 64 mA (external source connection possible)	
Internal power supply:	Bus power supply	
Power supply		
Supply voltage / tolerance:	27 V DC, -20 / +10 %	
Rated current:	110 mA (at 27V DC)	
Operating conditions		
Working temperature:	-20 to +55 °C	
Storage temperature:	-25 to +70 °C	
Humidity:	max. 80%	
Degree of protection:	IP20 devices, IP40 with cover in the switchboard	
Overvoltage category:	II.	
Degree of pollution:	2	
Operating position:	any	
Installation:	to the switching board on the EN60715 DIN rail	
Design:	6-MODULE	
Terminal:	max. 2.5 mm ²	
Dimensions and weight		
Dimensions:	90 x 105 x 65 mm	
Weights:	257 g	

- CU3-03M is a new, enhanced version of CU3-01M and CU3-02M.
- The new HW equipment allows communication with the DALI bus to connect up to 64 electronic ballasts (the internal power supply of the CU3-03M is capable of supplying connected ballasts up to a nominal value of 64 mA).
- RF Communication Interface for Controlling Wireless Receivers iNELS RF Control (the current list of supported receivers is available in the iNELS Installation Guide).
- The CU3-03M is equipped with three Ethernet ports, one for Ethernet (100 Mbps) connections and two for CU3-03M controllers.
- The CU3-03M has a TFT display that shows the current status and allows some basic unit parameters such as network setup, date, time, or service.
- The movement in the CU3-03M menu is possible by using the directional buttons on the front panel.
- CU3-03M in 6-MODULE are designed for mounting into a switchboard on the EN60715 DIN rail.

iNELS RF Control interface for CU3-03M

Communication protocol:	RF Touch Compatible
Transmitting frequency:	866 MHz / 868 MHz / 916 MHz
Signal transmission methods:	bidirectionally addressed message
Output for RF antenna:	SMA connector*
RF antenna:	1 dB (part of package)
Free space range:	up to 100 m

DIN = digital input
AOUT = analogue output
AIN = analogue input
GS = galvanically isolated

* Max Tightening Torque for antenna connector is 0.56 Nm.

Installation BUS:

- Two-wired BUS with an arbitrary topology (not only to be as closed circle).
- With its own modulated communications on the DC voltage supply.
- One line of BUS allows you to connect up max. 32 units of iNELS3.
- The current load of one line is max. 1A. When connecting units which draw greater than 1A, BPS3-01M with 3A sampling can be used.
- Maximum length of the BUS is approximately 500 m (depends on the voltage drop).
- Recommended cable:
 - iNELS BUS Cable - Twisted pair of copper wires with size of AWG20 wire (diameter of 0.812 mm, cross-section of 0.5190 mm²).

System BUS EBM:

- Used to connect the CU3-01M (02M) central unit with MI3-02M external masters, GSM communicator GSM3-01M or converter DALI/DMX EMDC-64M.
- EBM has strictly linear topology and wires are connected to terminals EBM + and EBM-, wires can not be interchanged.
- Max. length of the line of BUS is 500 m.
- The EBM BUS has to be terminated at both ends.
- This part adapted to be inserted between terminals is included into central units packages and it is necessary to insert between terminals EBM+ and EBM-.
- Recommended cabling:
 - CAT5e UTP and higher, or FTP CAT5e and higher or STP CAT5e and higher.

- The configurations of units and the whole system are done via Ethernet, through configuration software - iNELS3 Designer & Manager (iDM3), which is designed for operating systems Windows 7, Windows 8 and Windows 10.
- The central unit features two communication protocols:
 - ELKONET - to communicate with Connection Server or directly with the application iHC.
 - ASCII - communication with third systems and integration with BMS (Building Management Systems), for example Niagara 4.
- Supported Software:
 - Parameterization, configuration, control and visualization: iNELS3 Designer & Manager (iDM3).
 - iRidium mobile
 - Niagara Frameworks
 - Promotic
- By means of iDM3, you can update firmware of central units and peripheral units connected by BUS.

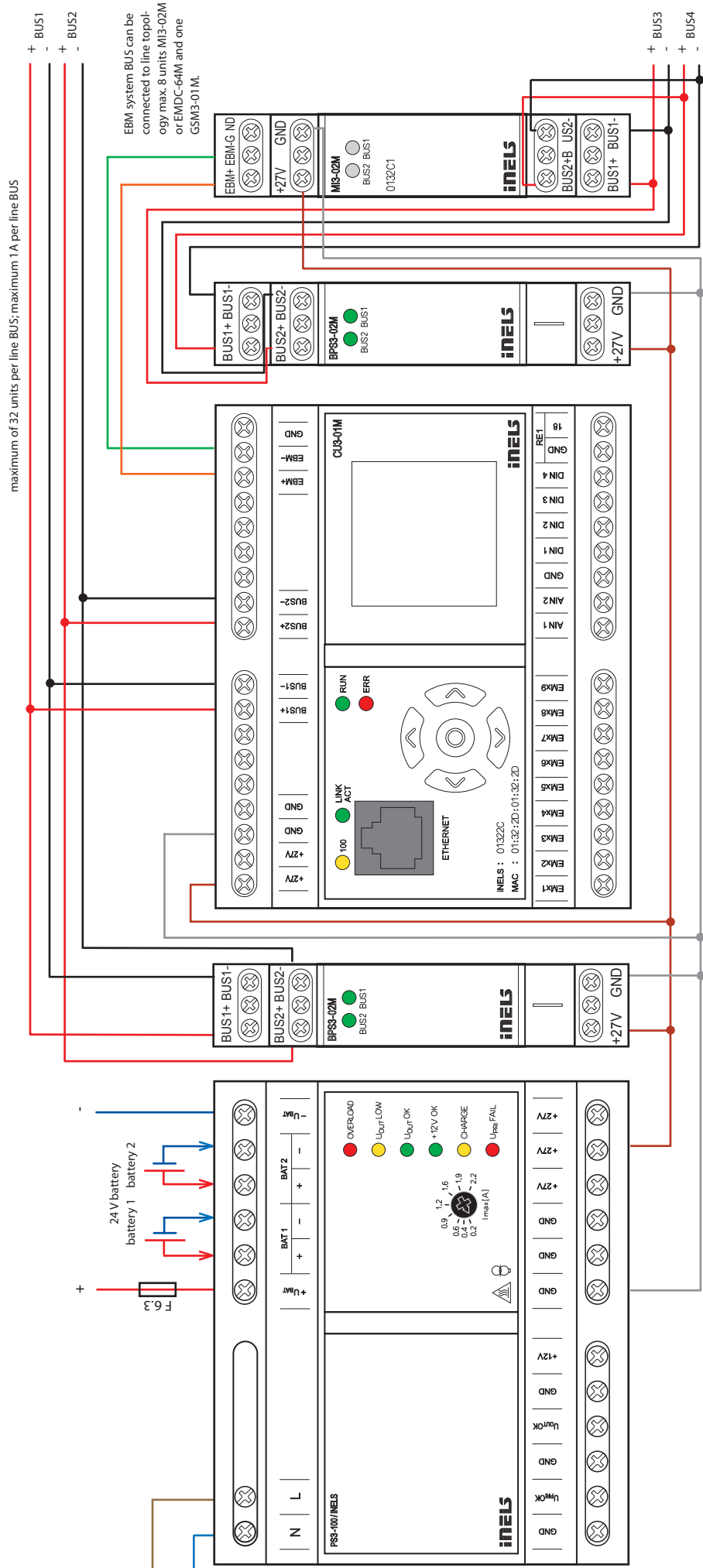

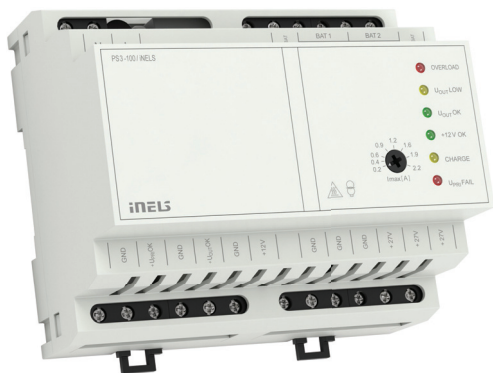

EAN code
PS3-100/iNELS: 8595188131568

- PS3-100/iNELS is a stabilized switching power supply, with the total power of 100 W.
- Used to supply central units and external master within intelligent electro-installation iNELS.
- Through BUS separators from the supply voltage BPS3-01M and BPS3-02M, it supplies supplies BUS lines from which iNELS peripheral units are also powered.
- Used in the instrumentation field.
- Fixed output voltage DC 27.6 V and DC 12.2 V, galvanically isolated from the mains.
- Power source of 27 V and 12 V have a common ground terminal GND.
- Electronic short circuit protection, high-capacity and thermal overload, over voltage.
- UPS functions - backup of output 24V and 12V on connected batteries.
- Recharging the batteries from 27 V source.
- Protection battery backup fuse - protection against short circuit and reverse polarity battery.
- Continuously adjustable maximum battery charging current.
- Indication of operating and fault conditions 6 LED diodes on the front panel of the power supply.
- 2 STATUS outputs with open collector for reporting operational status of the source.
- Source supplies power to the priority system iNELS, the remaining power is used for rechargeable batteries.
- When the battery is fully discharged, the battery is automatically disconnected from the load.
- PS3-100/iNELS in 6-MODULE version is designed for mounting into a switchboard, on DIN rail EN60715.

Indication LED

switching power supply works correctly
output voltage 27V is correct ($U_{OUT}>24V$)
output voltage 12V is correct
batteries are not recharged

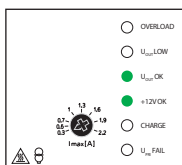

switching power supply not working correctly
- UPS mode
output voltage 27V is correct ($U_{OUT}>24V$)
output voltage 12V is correct
batteries are not recharged

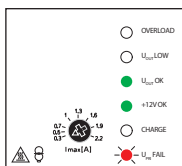

switching power supply works correctly
output voltage 27V is correct ($U_{OUT}>24V$)
output voltage 12V is correct
batteries are recharged

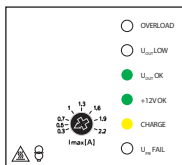

switching power supply not working correctly
- UPS mode
low output voltage 27V ($21V < U_{OUT} < 24V$)
output voltage 12V is correct
batteries are not recharged

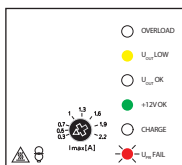

switching power supply works correctly
low output voltage 27V ($21V < U_{OUT} < 24V$)
output voltage 12V is correct
batteries are not recharged

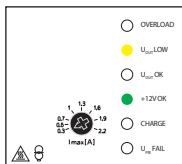

switching power supply works correctly
output voltage 27V is correct ($U_{OUT}>24V$)
low output voltage 12V (short-circuit, overload)
batteries are recharged

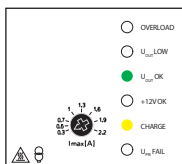

switching power supply is overload
low output voltage 27V ($U_{OUT}<21V$)
low output voltage 12V
batteries are not recharged

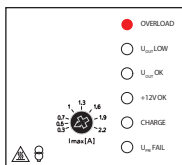

Example of connection

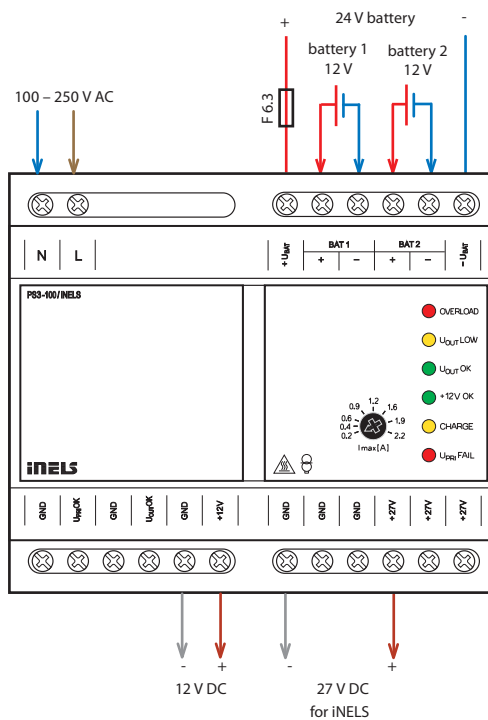

Technical parameters		PS3-100/iNELS
AC Input		
Power supply:	100 - 250 V AC / 50 - 60 Hz	
Dissipated power:	max. 20 W	
Power load (apparent / active):	max. 13 VA / 2 W	
Power consumption at max. load (apparent / active):	max. 180 VA / 111 W	
Protection:	- safety fuse T3.15 A inside the unit - electronic protection (short circuit current and thermal overload)	
DC Input		
Power supply:	DC 24 V (two 12V batteries in series)	
Protection:	- safety fuse F6.3 A external - electronic protection against current overload - each battery separately - separately routed extreme terminals (24)	
Automatic disconnect the battery:	- for the battery voltage <21 V - when exceeding discharge current 4.2 A	
Outputs		
Output voltage 1:	27.6 V	
Max. capacity:	3.6 A	
Output voltage 2:	12.2 V	
Max. capacity:	0.35 A	
The overall efficiency of resources:	about 88 %	
Time delay after connecting to the AC network:	max 1 s	
Max. charging current:	adjustable from 0.2 to 2.2 A	
LED Signalization		
Output voltage 27 V OK ($U_{OUT} > 24 V$):	green LED U_{OUT} OK	
Switch. power supply does not work (does not oscillate):	flashing red LED U_{PRI} FAIL (if a battery is connected)	
Low output voltage ($21 V < U_{OUT} < 24V$):	yellow LED U_{OUT} LOW	
Output voltage 12 V OK ($U > 11 V$):	green LED + 12 V OK	
Overloading the power supply ($U_{OUT} < 21 V$):	red LED OVERLOAD	
Charging the battery (charging current > 50mA):	yellow LED CHARGE	
Output status		
STATUS output 1 (U_{PRI} OK):	closed, when power supply works (not blinking LED U_{PRI} FAIL)	
STATUS output 2 (U_{OUT} OK):	closed, if $U_{OUT} > 21 V$ (not lit red LED OVERLOAD)	
Output type:	open collector current limited	
Max. connectable voltage:	50 V DC	
Max. current output:	50 mA	
Voltage drop on the switch max:	at 10 mA ... 140 mV at 30 mA ... 400 mV at 50 mA ... 700 mV	
Other Data		
Electric strength AC input - output:	4 kV	
The connection terminals:	row	
Cable size (mm ²):	max. 1 x 2.5, max. 2 x 1.5 (with sleeve max 1 x 1.5)	
Operating temperature:	-20 °C ... +55 °C	
Storage temperature:	-30 °C ... +70 °C	
Working humidity:	20 ... 90 % RH	
Cover:	IP20 device, IP40 mounting in the switchboard	
Overvoltage category:	III.	
Degree of pollution:	2	
Working position:	arbitrary, vertical is optimum	
Installation:	on the DIN rail EN60715	
Execution:	6-MODULE	
Dimensions:	90 x 105 x 65 mm	
Weight:	401 g	
Related standards:	general: EN61204, safety: EN61204-7, EMC: EN61204-3	

Description of device functions

- The device consists of several functional blocks.
- The basic part is 100 W power supply with 2 output voltage levels.
 - Voltage of 27.6 V is used to supply the system iNELS and to recharge the batteries.
 - Voltage of 12.2 V is for power as intrusion detectors (ESAS) or EFAS.
 - Both voltages are available without interruption during power AC power supply (UPS function) - assuming they are connected to a backup battery.
- Other parts of the source circuits are battery backup and recharge, which provide switching mode connection, charging and disconnecting the battery.
 - When in the backup mode, the battery is completely discharged, the circuit is immediately switched off to avoid deep discharge. The maximum discharge current is also guarded - when exceeded, the batteries are again disconnected.
 - If the switched source is working (oscillating), and its output voltage are greater than 26.9 V, the backup batteries are charged by the current, and the maximum value is set by trimmer on the panel source.
 - When charging the yellow LED CHARGE illuminates. The source first feeds the iNELS system, and the remaining capacity of up to 100 W only recharges the battery.
 - If the output is high, this disconnects the charge (the yellow LED CHARGE switches off).
 - Upon further increasing, the load further decreases the voltage source and the load current also flows from the battery (power supply and battery power to the load together).
 - If the source is disconnected from the AC network (does not oscillate), and you connect batteries now, the batteries remain disconnected and power outputs are without power. To activate, the source must be connected to the power supply.
- The last part of the unit are signaling circuits and status outputs.
 - STATUS outputs (see technical data) are equipped with current limiting, so they can switch signaling components directly without external resistors (e.g. LED, optocouplers or relay coil)
 - The LED signaling function is given in the table of technical parameters and illustratively described in seven case studies.



EAN code
MI3-02M: 8595188132411

Technical parameters MI3-02M

Outputs

Number of connected units:	max. 64 (2x32)
----------------------------	----------------

Communication

Installation BUS:	2x BUS for connection of peripheral units
-------------------	---

Data BUS:	for communication with central unit
-----------	-------------------------------------

Unit status indication:	green LED
-------------------------	-----------

BUS fault indication:	red LED
-----------------------	---------

Length of BUS wire:	max. 2x 500 m
---------------------	---------------

Length of BUS EBM wire:	max. 500 m
-------------------------	------------

Power supply

Supply voltage / tolerance:	27 V DC, -20 / +10 %
-----------------------------	----------------------

Dissipated power:	max. 1 W
-------------------	----------

Rated current:	25 mA (at 27V DC)
----------------	-------------------

Operating conditions

Operating temperature:	-20 .. +55 °C
------------------------	---------------

Storage temperature:	-25 .. +70 °C
----------------------	---------------

Humidity:	max. 80 %
-----------	-----------

Protection degree:	IP20 device, IP40 mounting in the switchboard
--------------------	---

Overvoltage category:	II.
-----------------------	-----

Pollution degree:	2
-------------------	---

Operating position:	any
---------------------	-----

Installation:	in a switchboard on DIN rail EN 60715
---------------	---------------------------------------

Design:	1-MODULE
---------	----------

Terminal:	max. 2.5 mm ²
-----------	--------------------------

Dimensions and weight

Dimensions:	90 x 17.6 x 64 mm
-------------	-------------------

Weight:	58 g
---------	------

- External master MI3-02M provides expansion of the amount of units iNELS3 connected to the central unit CU3-01M or CU3-02M of two other lines of BUS (i.e. about 2x32 peripheral units).
- Through the system BUS EBM, it is possible to connect to one central unit up to 8 external masters MI3-02M.
- Combining central unit CU3-01M (02M) and 8 external masters MI3-02M we can reach maximum capacity of iNELS system up to 576 peripheral units.
- If you require an extended system then it is possible to use communication of up to 8 central units with Connection server using ELKONET protocol, eventually the integration of more central units into BMS via ASCII protocol.
- MI3-02M have marked on the front panel of the unique hardware address. This address belongs to the line BUS1. Hardware address of BUS2 line is always one value higher than for BUS1.
- MI3 units are supplied from PS3-100/iNELS.
- To power the lines BUS, it is necessary to use a BUS separator BPS3-02M or BPS3-01M (supply only one line).
- Status signaling of each BUS (operation, fault) is indicated by two-color LEDs on the front panel of the module.
- The last MI2-02M connected to the EBM BUS must be closed with a 120 Ω termination resistor. This part adapted to be inserted between terminals is included into central units packages and it is necessary to insert between terminals EBM+ and EBM-.
- MI3-02M in 1-MODULE version is designed for mounting into a switchboard, on DIN rail EN60715.

Connection

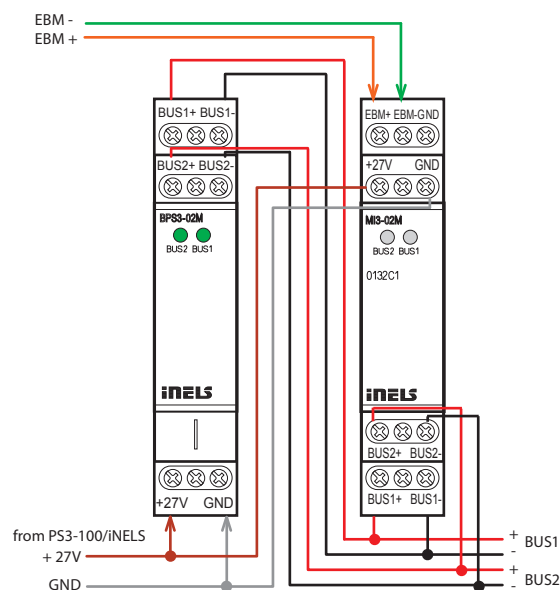



EAN code
MI3-02M/ETH: 8595188134897

Technical parameters		MI3-02M/ETH
Indication LED		
Power indication:		green LED Un
Unit status indication		
BUS / EBM:		green LED BUS1, BUS2 / EBM
BUS / EBM bus fault indication:		red LED BUS1, BUS2 / EBM
RF communication indication:		red LED RF STATUS
Communication		
BUS with integrated BPS3		
Max. BUS output current:		2x 1A
Maximum number of units:		max. 2x 32 units
Maximum cable length:		max. 500 m (depends on power loss)
2x konektor ETH		Connection to CU3-03M or to another external MI3-02M / ETH master
Connectors:		RJ45 on the underside of the product
Communication speed:		100 Mbps
Ethernet status indication:		2x green - Communication Ethernet 2x yellow – Speed Ethernet 100 Mbps
Power supply		
Supply voltage / tolerance:		27 V DC, -20 / +10 %
Rated current without output load:		max. 75mA (at 27 V DC)
Operating conditions		
Operating temperature:		-20 .. +55 °C
Storage temperature:		-25 .. +70 °C
Humidity:		max. 80%
Protection degree:		IP20 device, IP40 mounting in the switchboard
Overvoltage category:		II.
Pollution degree:		2
Operating position:		any
Installation:		in a switchboard on DIN rail EN 60715
Design:		3-MODULE
Terminal:		max. 2.5 mm ² / 1.5 mm ² with sleeve
Dimensions and weight		
Dimensions:		90 x 52 x 65 mm
Weight:		200 g

iNELS RF Control interface for MI3-02M/EHT	
Communication protocol:	RF Touch Compatible
Transmitting frequency:	866 MHz / 868 MHz / 916 MHz
Signal transmission methods:	bidirectionally addressed message
Output for RF antenna:	SMA connector*
RF antenna:	1 dB (part of package)
Free space range:	up to 100m

* Max Tightening Torque for antenna connector is 0.56 Nm.

- The external master MI3-02M/ETH allows two additional BUS branches (i.e., 2x 32 peripheral units) to extend the number of connected iNELS3 peripheral units to the CU3-01M, CU3-02M or CU3-03M central unit.
- Part of the External Master MI3-02M/ETH is also a bus separator (BPS3), which supplies the two BUS connected to this master with 2x1A current.
- The unit can communicate via the EBM system bus with the CU3-01M, CU3-02M or CU3-03M (ETH) Ethernet interface.
- The advantage of using Ethernet communication is faster data transfer between masters and faster system response.
- ETH ports are used to connect up to 8 external MI3-02M/ETH master units, where one port is an input port, the other outputs and serves to interconnect units. It is possible to connect CU3-03M and up to 8 MI3-02M/ETH into a "circle" or it is possible to interconnect the EBM system bus with the CU3-01M, CU3-02M central unit and extend this system up to 8 external MI3-02M/ETH master units.
- The MI3-02M/ETH is powered from PS3-100/iNELS.
- The MI3-02M/ETH is equipped with an RF module for communication with selected units of iNELS RF Control.
- The status of each BUS (Run, Error) is signalled by the appropriate colour LED on the front panel of the unit.
- If this is the last unit on the EBM system bus, it is necessary to terminate the line with a resistor with a nominal resistor value of 120Ω. This element, which is designed for easy insertion into the terminals, is part of a package of central units and external masters and is inserted between the EBM + and EBM- terminals.
- MI3-02M/ETH in 3-MODULE version is designed for mounting into a switchboard, on DIN rail EN60715.

Connection

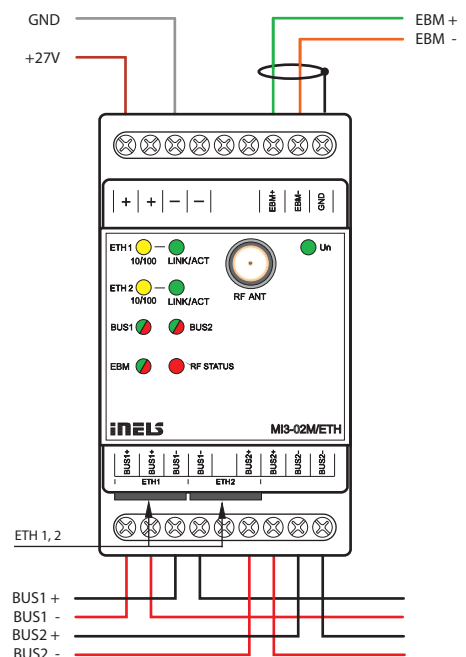



EAN code
BPS3-01M: 8595188132442
BPS3-02M: 8595188132435

Technical parameters BPS3-01M BPS3-02M

Outputs

Maximum capacity:	3A	2x 1A
-------------------	----	-------

Communication

Installation BUS:	1x BUS	2x BUS
-------------------	--------	--------

Power supply

Supply voltage / tolerance:	27 V DC, -20 / +10 %	
-----------------------------	----------------------	--

Dissipated power:	max. 0.5 W	
-------------------	------------	--

Rated current:	max. 8 mA	max. 15 mA
----------------	-----------	------------

Status indication voltage on terminals:	1 x green LED	2 x green LED
---	---------------	---------------

Connection

Terminals:	max. 2.5 mm ² / 1.5 mm ² with sleeve	
------------	--	--

Operating conditions

Operating temperature:	-20 .. +55 °C	
------------------------	---------------	--

Storage temperature:	-30 .. +70 °C	
----------------------	---------------	--

Protection degree:	IP20 device, IP40 mouting in to the switchboard	
--------------------	---	--

Overvoltage category:	II.	
-----------------------	-----	--

Pollution degree:	2	
-------------------	---	--

Operating position:	any	
---------------------	-----	--

Installation:	in a switchboard on DIN rail EN 60715	
---------------	---------------------------------------	--

Design:	1-MODULE	
---------	----------	--

Dimensions and weight

Dimensions:	90 x 17.6 x 64 mm	
-------------	-------------------	--

Weight:	70 g	85 g
---------	------	------

- Units BPS3-01M and BPS3-02M serve for impedance separation of BUS from supply voltage power.
- BUS separator BPS3 or BPS3-01M-02M is required for each type CU3-01M (02M) central unit and external master MI3-02M.
- BPS3-01M allows you to connect one BUS with max. load 3 A.
- BPS3-02M allows you to connect two separate BUS1 and BUS2 with max. load 1 A for each line.
- Outputs are equipped with overcurrent and overvoltage protection.
- Indication of output voltage outputs BUS LED.
- BPS3-01M and BPS3-02M in 1-MODULE version is designed for mounting into a switchboard, on DIN rail EN60715.

Connection

BPS3-01M

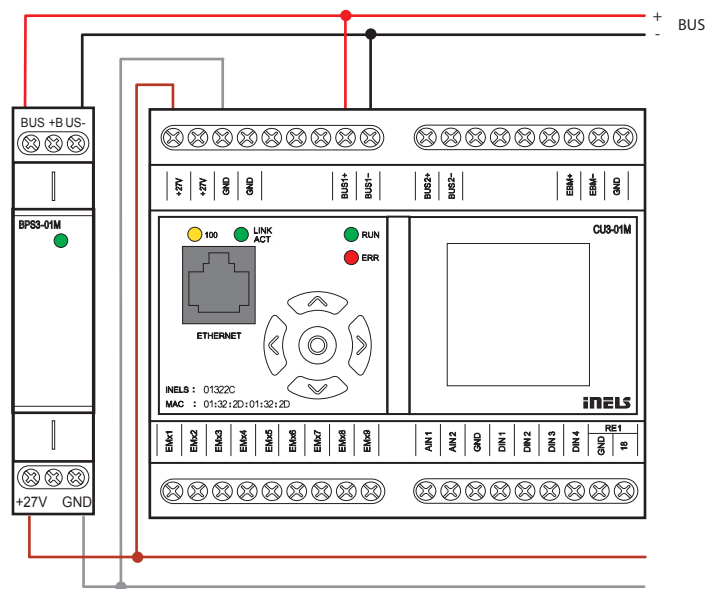

BPS3-02M

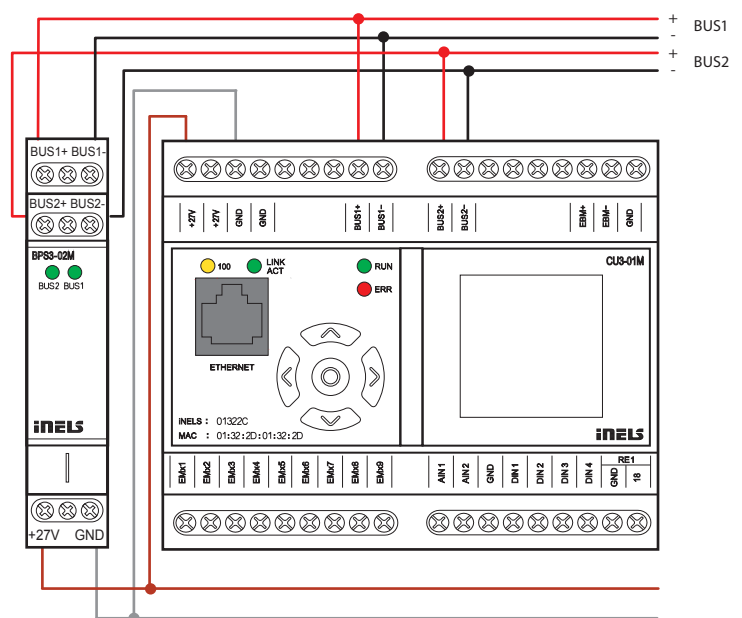



EAN code
GSM3-01M: 8595188132428

Technical parameters		GSM3-01M
Communication		
Communication interface:	system BUS EBM	
GSM network (Quad-band):	850/900/1800/1900 MHz	
Transmitter output power:	2 W for GSM 900, 1 W for GSM 1800	
Number of supported calls:	8 incoming, 8 outgoing	
Number of informative SMS:	32 incoming, 32 outgoing	
Number of telephone numbers:	up to 512	
LED indication - operation state / fault in BUS:	LED STATUS	
Output for antenna:	SMA connector*	
Power supply		
Supply voltage / tolerance:	27 V DC, -20 / +10 %	
Rated current:	250 mA (at 27V DC) / max. 1 A	
Supply voltage indication:	green LED Un	
Connection		
Terminals:	max. 2.5 mm ² /1.5 mm ² with sleeve	
Operating conditions		
Operating temperature:	-20 to +55 °C	
Storing temperature:	-30 to +70 °C	
Protection degree:	IP20 devices, IP40 with cover in switchboard	
Overvoltage category:	II.	
Pollution degree:	2	
Operation position:	any	
Installation:	to DIN rail EN 60715	
Design:	3-MODULE	
Dimensions and weight		
Dimensions:	90 x 52 x 65 mm	
Weight:	132 g	

* Max Tightening Torque for antenna connector is 0.56 Nm.

- It serves for communication with the iNELS system via commands sent in short SMS messages from mobile phone GSM.
- With the GSM3-01M and a smartphone, it is possible by SMS message or a call to control the iNELS system or obtain information on its status and current events.
- By means of the software iDM3, you can use up to 8 incoming calls, 8 outgoing calls, 32 incoming SMS messages and 32 outgoing SMS messages.
- For SMS messaging, the message length is limited to 32 characters, and for each message, you can set up to eight telephone numbers. In total, it is possible in iDM3 to use up to 512 telephone numbers.
- One telephone number can be set for each incoming and outgoing call.
- The maximum length of an incoming call is around 30s, and then the GSM3-01M hangs up. The user can set the length of outgoing calls in the software iDM3.
- GSM3-01M can be used for informing users about any system status, e.g. in the event of a fault in some technology or building interference.
- Operating range is 850, 900 as well as 1800, 1900 MHz (quad-band).
- SIM card is inserted into the unit from the front panel.
- The MINI USB connector on the front panel is used for servicing, but configuration of telephone numbers, SMS messages and calls is done from the software iDM3.
- GSM3-01M connects to the central unit CU3-01M (02M) via the EBM system BUS (terminals EBM+ and EBM-).
- In case it involves the last unit on the system BUS EBM, it is necessary to terminate the wire with a resistor with rated resistance of 120Ω. This part adapted to be inserted between terminals is included into central units packages and it is necessary to insert between terminals EBM+ and EBM-.
- The package includes an external magnetic antenna (cable 3m, 5db gain), which is connected to the connector RSMA (F) on the front panel.
- GSM3-01M in 3-MODULE version is designed for mounting into a switchboard, on DIN rail EN60715.

Connection

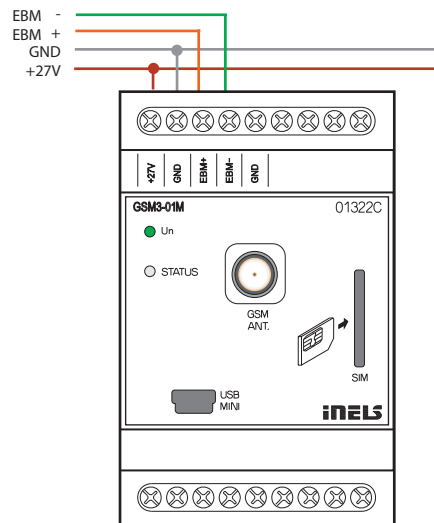



EAN code
SA3-02M: 8595188132374

Technical parameters SA3-02M

Outputs	
Output:	2x changeover 16 A/AC1
Switching voltage:	250 V AC1, 24 V DC
Switching load:	4000 VA/AC1, 384 W/DC
Surge current:	30 A; max. 4 s. at duty cycle 10%
Output relays separated from all internal circuits:	reinforced Insulation (Cat. II surges by EN 60664-1)
Isolation between relay outputs RE1 and RE2:	reinforced Insulation (Cat. II surges by EN 60664-1)
Isolates. voltage open relay contact:	1 kV
Minimal switching current:	100 mA
Switching frequency/no load:	1200 min ⁻¹
Switching frequency/rated load:	6 min ⁻¹
Mechanical lifetime:	3x 10 ⁷
Electrical lifetime AC1:	0.7x 10 ⁵
Outputs indication:	2x yellow LED
Communication	
Installation BUS:	BUS
Power supply	
Supply voltage / tolerance:	27 V DC, -20 / +10 %
Dissipated power:	max. 4 W
Rated current:	50 mA (at 27V DC), from BUS
Status indication unit:	green LED RUN
Connection	
Terminal:	max. 2.5 mm ² /1.5 mm ² with sleeve
Operating conditions	
Air humidity:	max. 80 %
Operating temperature:	-20 to +55 °C
Storing temperature:	-30 to +70 °C
Protection degree:	IP20 device, IP40 mounting in the switchboard
Overvoltage category:	II.
Pollution degree:	2
Operation position:	any
Installation:	switchboard on DIN rail EN 60715
Design:	1-MODULE
Dimensions and weight	
Dimensions:	90 x 17.6 x 64 mm
Weight:	82 g

- Actuator SA3-02M is designed for switching two various appliance and loads with potentialless contact.
- SA3-02M is a switching actuator containing 2 independent relays with changeover potentialless contacts.
- Maximum load per contact is 16 A/4000 VA/AC1.
- Each of the two output contacts are individually controllable and addressable.
- Both relays are individually decorated input terminals, and therefore can switch various independent potentials.
- The actuator is designed for switching up to two various appliances and loads relay output (potentialless contact).
- Thanks to changeover contacts, it can be used to control one 230 V power (such as blinds, shutters or awnings) with appropriate bridging, the contacts can secure hardware blocking the possibility of simultaneous switching of the phase on both outputs, see example of connection.
- LEDs on the front panel signal the status of each output.
- Contact status of each relay can be changed separately and manually by control buttons on the front panel.
- Switching actuators SA3 are normally supplied in the option AgSnO₂ contact material.
- SA3-02M in 1-MODULE version is designed for mounting into a switchboard, on DIN rail EN60715.

Connection

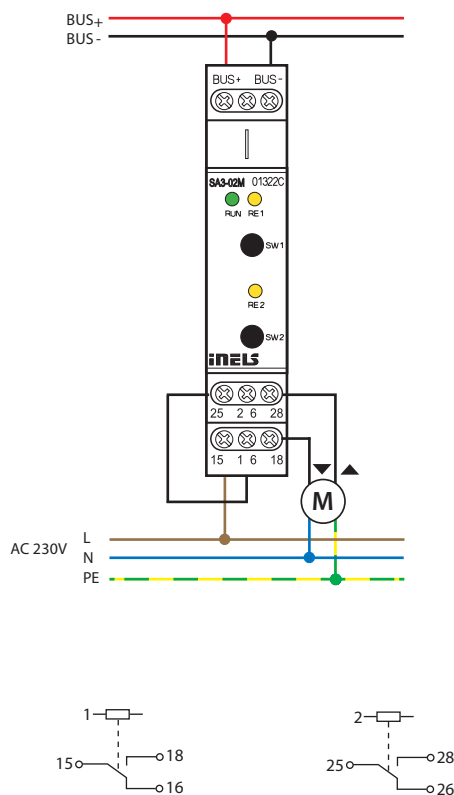



EAN code
SA3-04M: 8595188132381

Technical parameters		SA3-04M
Outputs		
Output:	4x changeover 16 A/AC1	
Switching voltage:	250 V AC1, 24 V DC	
Switching output:	4000 VA/AC1, 384 W/DC	
Surge current:	30 A; max. 4 s. at 10% duty cycle	
Output relays separated from all internal circuits:	reinforced Insulation (Cat. II surges by EN 60664-1)	
Isolation between relay outputs RE1-3 and RE4:	reinforced Insulation (Cat. II surges by EN 60664-1)	
Isolation between relay outputs RE1-3:	basic insulated. (Cat. II surges by EN 60664-1)	
Isolates. voltage open relay contact:	1 kV	
Min. switched current:	100 mA	
Switching frequency /no load:	1200 min ⁻¹	
Switching frequency/rated load:	6 min ⁻¹	
Mechanical life:	3x 10 ⁷	
Electrical life AC1:	0.7x 10 ⁵	
Output indication:	4x yellow LED	
Communication		
Installation BUS:	BUS	
Power supply		
Supply voltage / tolerance:	27 V DC, -20 / +10 %	
Dissipated power:	max. 4 W	
Rated current:	70 mA (at 27V DC), from BUS	
Status indication unit:	green LED RUN	
Connection		
Terminal:	max. 2.5 mm ² /1.5 mm ² with sleeve	
Operating conditions		
Air humidity:	max. 80 %	
Operating temperature:	-20 to +55 °C	
Storing temperature:	-30 to +70 °C	
Protection degree:	IP20 device, IP40 mounting in the switchboard	
Overvoltage category:	II.	
Pollution degree:	2	
Operation position:	any	
Installation:	switchboard on DIN rail EN 60715	
Design:	3-MODULE	
Dimensions and weight		
Dimensions:	90 x 52 x 65 mm	
Weight:	164 g	

- SA3-04M is a switching actuator containing 4 independent relays with changeover potentialless contacts.
- Maximum load per contact is 16 A/4000 VA/AC1.
- Each of the four output contacts are individually controllable and addressable.
- All four relays are individually decorated input terminals, and therefore can switch various independent potentials.
- The actuator is designed for switching to four various appliances and loads relay output (potential free contact).
- Thanks to changeover contacts, it can be used to control up to two drives 230 V power (such as blinds, shutters or awnings) with appropriate bridging, the contacts can secure hardware blocking the possibility of simultaneous switching of the phase on both outputs, see example of connection.
- LEDs on the front panel signal the status of each output.
- Contact status of each relay can be changed separately and manually by control buttons on a front panel.
- Switching actuators SA3 is normally supplied in the option AgSnO₂ contact material.
- SA3-04M in 3-MODULE version is designed for mounting into a switchboard, on DIN rail EN60715.

Connection

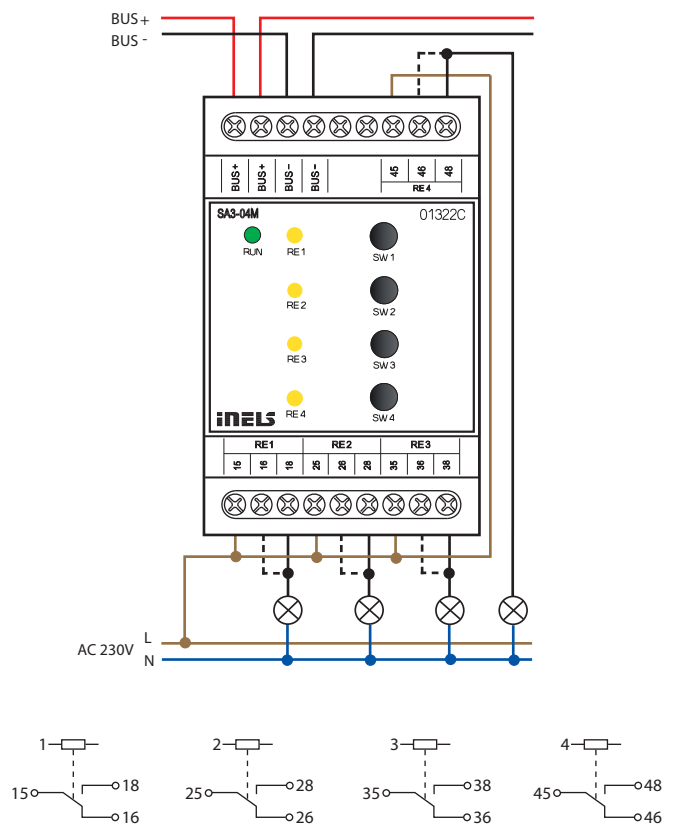



EAN code
SA3-06M: 8595188132879

- The actuator is designed for switching up to six various appliances and loads with potentialless contact.
- SA3-06M is a switching actuator contains 6 independent relays with changeover potentialless contacts.
- Maximum load per contact is 8 A/2000 VA/AC1.
- Each of six output contacts are individually controllable and addressable.
- The relays are divided into two groups, the group of four relays on the bottom terminal switches the common potential, a pair of relays on top of the terminal switches second common potential.
- The actuator is suitable for operating discontinuously controlled thermo drives in the distributor underfloor heating.
- LEDs on the front panel signal the status of each output.
- Contact status of each relay can be changed separately and manually by control buttons on a front panel.
- SA3-06M is normally supplied in the option AgSnO₂ contact material.
- SA3-06M in 3-MODULE version is designed for mounting into a switchboard/DIN rail EN60715.

Technical parameters

SA3-06M

Outputs

Output:	6x changeover 8 A/AC1
Switching voltage:	250 V AC1, 24 V DC
Switching output:	2000 VA/AC1, 192 W/DC
Surge current:	10 A
Output relays separated from all internal circuits:	reinforced Insulation (Cat. II surges by EN 60664-1)
Isolation between relay outputs COM1 and COM2:	reinforced Insulation (Cat. II surges by EN 60664-1)
Isolation between individual relay outputs:	basic insulated. (Cat. II surges by EN 60664-1)
Isolates. voltage open relay contact:	1 kV
Max. current terminals COM1 and COM2:	16 A
Min. switched current:	100 mA/ 5V DC
Switching frequency /no load:	300 min ⁻¹
Switching frequency/rated load:	15 min ⁻¹
Mechanical life:	2x 10 ⁷
Electrical life AC1:	5x 10 ⁴
Output indication:	6x yellow LED

Communication

Installation BUS:	BUS
-------------------	-----

Power supply

Supply voltage / tolerance:	27V DC, -20 / +10 %
Dissipated power:	max. 9 W
Rated current:	60 mA (at 27V DC), from BUS
Status indication unit:	green LED RUN

Connection

Terminal:	max. 2.5 mm ² / 1.5 mm ² with sleeve
-----------	--

Operating conditions

Air humidity:	max. 80%
Operating temperature:	-20 .. +55 °C
Storing temperature:	-30 .. +70 °C
Protection degree:	IP20 device, IP40 mounting in the switchboard
Overvoltage category:	II.
Pollution degree:	2
Operation position:	any
Installation:	switchboard on DIN rail EN 60715
Design:	3-MODULE

Dimensions and weight

Dimensions:	90 x 52 x 65 mm
Weight:	160 g

Connection

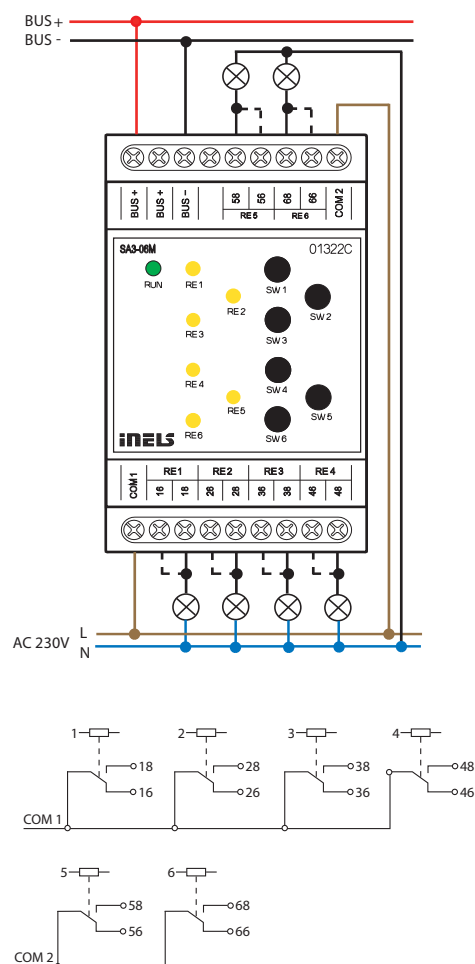



EAN code
SA3-012M: 8595188132466
SA3-012M/120V: 8595188133029

- The actuator is designed for switching to twelve various appliances and loads with potentialless contact.
- SA3-012M is a switching actuator containing 12 independent relays with NO potentialless contacts, with the fact that switches the same potential.
- Maximal loadability of contacts is 8 A/2000 VA/AC1.
- Each of the twelve output contacts are individually controllable and addressable.
- Actuator SA3-012M is powered by an AC voltage 230V. The unit SA3-012M/120V is powered by AC voltage 120V AC.
- BUS is galvanically separated from the internal circuits of unit.
- LED on front panel signalizes state of each output.
- Contact status of each relay can be changed separately and manually by control buttons on a front panel.
- SA3-012M is normally supplied in the option AgSnO₂ contact material.
- SA3-012M in design 6-MODULE is designed to be mounted into a switchboard, onto DIN rail EN60715.

Technical parameters SA3-012M SA3-012M/120V

Outputs

Output:	12x NO 8 A/AC1
Switched voltage:	250 V AC1, 24 V DC
Switched output:	2000 VA/AC1, 192 W/DC
Peak current:	10 A
Output relays separated from all internal circuits:	reinforced Insulation (Cat. II surges by EN 60664-1)
Isolation between relay outputs COM1, COM2 and COM3:	reinforced Insulation (Cat. II surges by EN 60664-1)
Isolates. voltage open relay contact:	1 kV
Max. current of one common terminal:	16 A
Minimal switched current:	100 mA / 10 V DC
Switching frequency without load:	300 min ⁻¹
Switching frequency with rated load:	15 min ⁻¹
Mechanical life:	1x 10 ⁷
Electrical life AC1:	1x 10 ⁵
Output indication:	12 x yellow LED

Communication

Installation BUS:	BUS
The installation BUS is separated from all internal circuits:	reinforced Insulation (Cat. II surges by EN 60664-1)
Status indication unit:	green LED RUN

Power supply

Voltage of BUS / tolerance / nominal current:	27V DC, -20 / +10 %, 5mA	
Supply voltage of power section (relay) tolerance / nominal current:	AC 230V (50 Hz), -15 / +10 %, 20 mA	AC 120V (60 Hz), -15 / +10 %, 40 mA
Dissipated power:	max. 6 W	max. 5 W

Connection

Terminal:	max. 2.5 mm ² /1.5 mm ² with sleeve
-----------	---

Operating conditions

Operating temperature:	-20 to +55 °C
Storing temperature:	-30 to +70 °C
Protection degree:	IP20 device, IP40 mounting in the switchboard
Overvoltage category:	II.
Pollution degree:	2
Operating position:	any
Installation:	switchboard on DIN rail EN 60715
Design:	6-MODULE

Dimensions and weight

Dimensions:	90 x 105 x 65 mm
Weight:	310 g

Connection

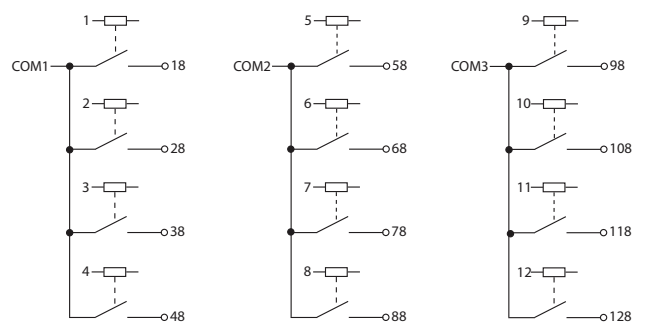
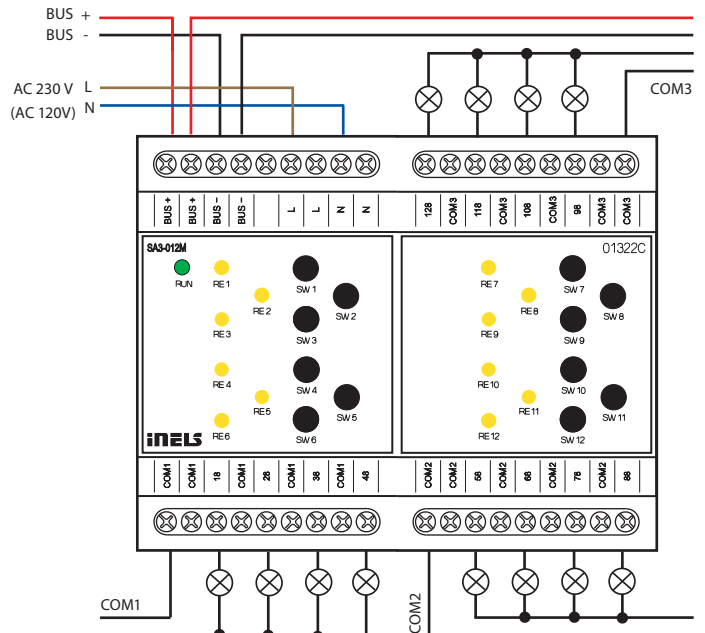

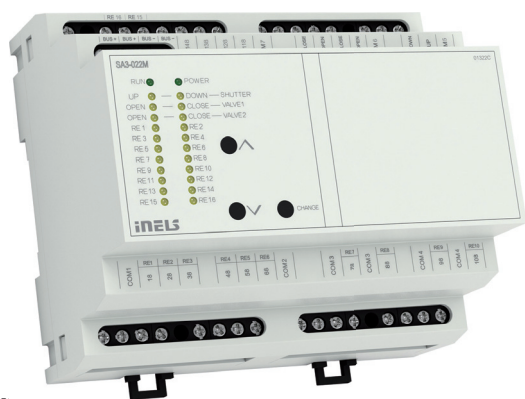

EAN code
SA3-022M: 8595188135269

- SA3-022M is an expansion module for the CU3-03M central unit, designed primarily for controlling the hotel room.
- Equipped with 22 relay outputs (of which 1x changeover contact – roller blinds, blinds).
- Switch lighting and socket circuits (6A and 10A relay) with common potential at the "COMx" terminal.
- Control of roller blinds, blinds (24 - 230 V AC / DC).
- Relay control of the fan coil unit - heating / cooling, 3 fan speeds (24 - 230 V AC / DC).
- Connection to BUS, communication with CU3-03M.
- The front panel LEDs indicate the status of each output.
- SA3-022M in design 6-MODULE is designed to be mounted into a switchboard, onto DIN rail EN60715.

Technical parameters

SA3-022M

Outputs

Output indication:	yellow LED
Output relays separated from all internal circuits:	reinforced Insulation *
Insulation between COM potentials:	reinforced Insulation *
Isolates. voltage open relay contact:	1 kV
SSR (Electronic Relay):	4x NO (OUT3 - OUT6)
Switching voltage:	20 - 240 V AC
Switching output:	480 VA
Surge current:	20 A, $t \leq 16$ ms
Relay 6A:	12x NO (RE1 - RE6, RE11 - RE16), 1x HW block changeover (OUT1, OUT2)
Switching voltage:	250 V AC1, 30 V DC
Switching output:	1500 VA/AC1, 180 W/DC
Minimum switching load:	500 mW (12 V / 10 mA)
Mechanical life:	10×10^6
Electrical life AC1:	6×10^4
Relay 10A:	4x NO (RE7 - RE10)
Switching voltage:	250 V AC1, 24 V DC
Switching output:	2500 VA/AC1, 240 W/DC
Surge current:	30 A max. 4s at 10%
Minimal switched current:	100 mA
Switching frequency without load:	1200 min^{-1}
Switching frequency with rated load:	6 min^{-1}
Mechanical life:	3×10^7
Electrical life AC1:	0.7×10^5

Communication

Installation BUS:	BUS
Unit status indication:	green LED POWER

Power supply

Supply voltage / tolerance:	27 V DC, -20 / +10 %
Rated current:	100 mA (at 27V DC), from BUS
Power status indication:	green LED RUN

Connection

Terminal:	max. 2.5 mm ² /1.5 mm ² with sleeve
-----------	---

Operating conditions

Operating temperature:	-20 to +55 °C
Storing temperature:	-30 to +70 °C
Protection degree:	IP20 device, IP40 mounting in the switchboard
Overvoltage category:	II.
Pollution degree:	2
Operating position:	any
Installation:	switchboard on DIN rail EN 60715
Design:	6-MODULE

Dimensions and weight

Dimensions:	90 x 105 x 65 mm
Weight:	307 g

Connection

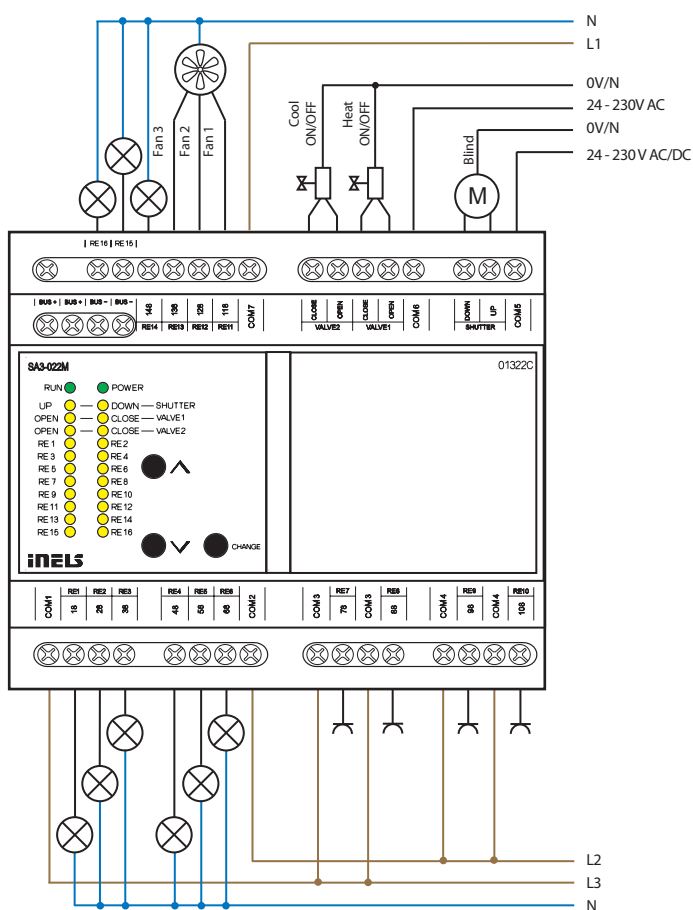

* (Cat. II surges by EN 60664-1)

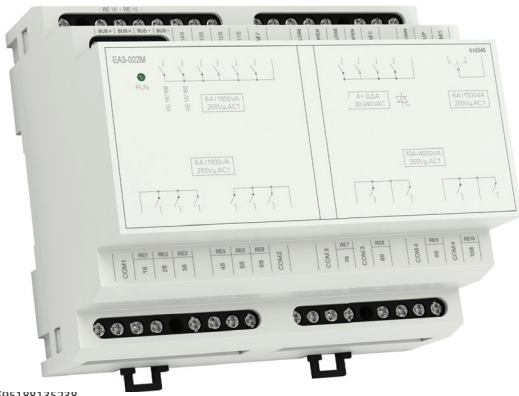

EAN code
EA3-022M: 8595188135238

- SA3-022M is an expansion module for the CU3-03M central unit, designed primarily for controlling the hotel room.
- Equipped with 22 relay outputs (of which 1x changeover contact – roller blinds, blinds).
- Switch lighting and socket circuits (6A and 10A relay) with common potential at the "COMx" terminal.
- Control of roller blinds, blinds (24 - 230 V AC / DC).
- Relay control of the fan coil unit - heating / cooling, 3 fan speeds (24 - 230 V AC / DC).
- Connection to BUS, communication with CU3-03M.
- The front panel LEDs indicate the status of each output.
- SA3-022M in design 6-MODULE is designed to be mounted into a switchboard, onto DIN rail EN60715.

Technical parameters	EA3-022M
Outputs	
Output relays separated from all internal circuits:	reinforced Insulation *
Insulation between COM potentials:	reinforced Insulation *
Isolates. voltage open relay contact:	1 kV
SSR (Electronic Relay):	4x NO (OUT3 - OUT6)
Switching voltage:	20 - 240 V AC
Switching output:	480 VA
Surge current:	20 A, t ≤ 16 ms
Relay 6A:	12x NO (RE1 - RE6, RE11 - RE16), 1x HW block changeover (OUT1, OUT2)
Switching voltage:	250 V AC1, 30 V DC
Switching output:	1500 VA/AC1, 180 W/DC
Minimum switching load:	500 mW (12 V / 10 mA)
Mechanical life:	10x10 ⁶
Electrical life AC1:	6x10 ⁴
Relay 10A:	4x NO (RE7 - RE10)
Switching voltage:	250 V AC1, 24 V DC
Switching output:	2500 VA/AC1, 240 W/DC
Surge current:	30 A max. 4s at 10%
Minimal switched current:	100 mA
Switching frequency without load:	1200 min ⁻¹
Switching frequency with rated load:	6 min ⁻¹
Mechanical life:	3x 10 ⁷
Electrical life AC1:	0.7x 10 ⁵
Communication	
Installation BUS:	BUS
Unit status indication:	green LED RUN
Power supply	
Supply voltage / tolerance:	27 V DC, -20 / +10 %
Rated current:	100 mA (at 27 V DC), from BUS
Connection	
Terminal:	max. 2.5 mm ² /1.5 mm ² with sleeve
Operating conditions	
Operating temperature:	-20 to +55 °C
Storing temperature:	-30 to +70 °C
Protection degree:	IP20 device, IP40 mounting in the switchboard
Overvoltage category:	II.
Pollution degree:	2
Operating position:	any
Installation:	switchboard on DIN rail EN 60715
Design:	6-MODULE
Dimensions and weight	
Dimensions:	90 x 105 x 65 mm
Weight:	337 g

Connection

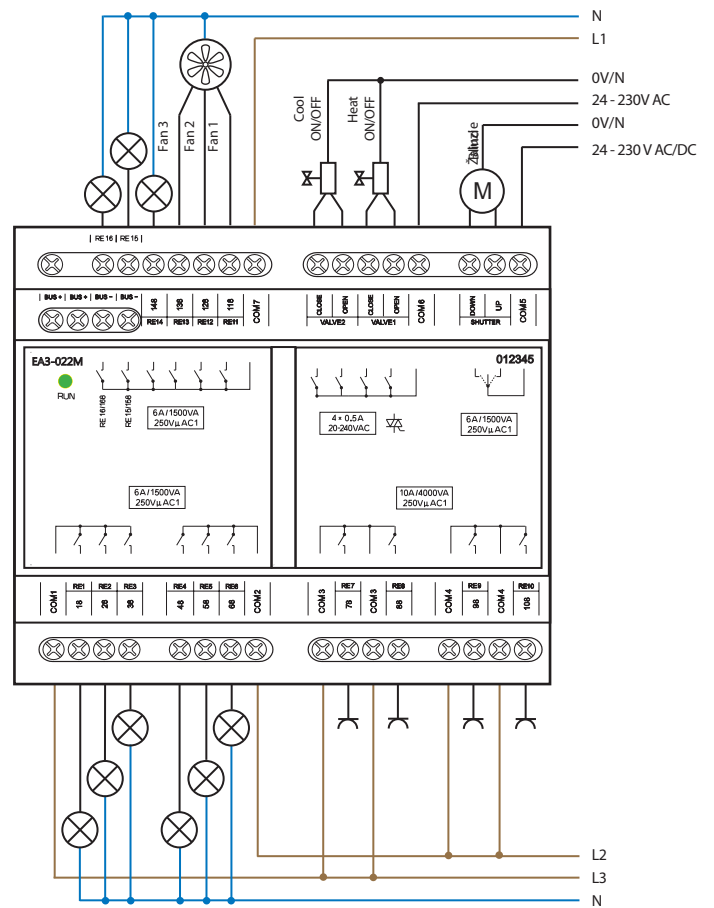

* (Cat. II surges by EN 60664-1)

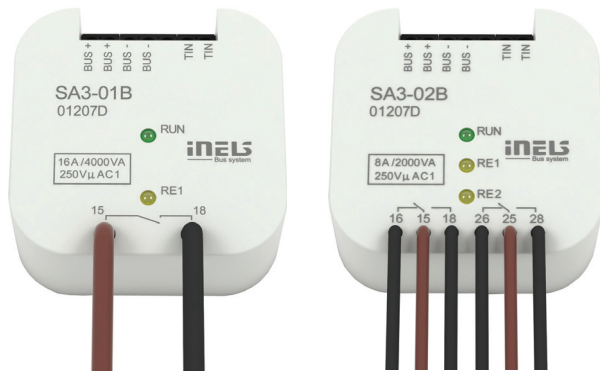

EAN code
SA3-01B: 8595188132350
SA3-02B: 8595188132367

- Actuators are designed for switching of one (SA3-01B), respectively two (SA3-02B) of various appliances and loads relay output (potential-less contact).
- SA3-01B contains 1 relay with switching potentialless contact with max. load 16 A/4000 VA/AC1.
- SA3-02B contains 2 relays with switching potentialless contacts with max. load 8 A/2000 VA/AC1.
- Output contacts are separately controllable and addressable.
- Both relay actuator SA3-02B are individually decorated input terminals, and therefore can switch various independent potentials.
- Thanks to changeover contacts, the SA3-02B actuator can be used to control a 230 V drive (such as blinds, shutters or awnings), whereas by proper bridging of contacts, it is possible to secure locking hardware options while switching on phase two outputs.
- Actuators are equipped with a temperature input for connecting an external two-wire temperature sensor TC / TZ (see accessories).
- LED on front panel signalizes state of each output.
- SA3 is normally supplied in the option AgSnO₂ contact material.
- SA3-01B, SA3-02B are designed for mounting into the installation box.

Technical parameters	SA3-01B	SA3-02B
Inputs		
Temperature measuring:	Yes, input for external thermo sensor TC, TZ	
Scope and accuracy of tem. meas.:	-20 .. +120°C; 0.5°C from the range	
Outputs		
Output:	1x NO 16 A/AC1	2x NC 8 A/AC1
Switching voltage:	250 V AC, 24 V DC	
Switched load:	4000 VA/AC1, 384 W/DC	2000 VA/AC1, 192 W/DC
Surge current:	30 A; max. 4 s. when repeating 10%	10A
Output relays separated from all internal circuits:	reinforced insulation (Cat. II surges by EN 60664-1)	
Insulation voltage between relay outputs RE1-RE2:	x	basic isolation (Cat. II surges by EN 60664-1)
Minimal switching current:	100 mA / 5 V	
Switching frequency/no load:	1200 min ⁻¹	300 min ⁻¹
Switching frequency/rated load:	6 min ⁻¹	15 min ⁻¹
Mechanical lifetime:	3x 10 ⁷	1x 10 ⁷
Electrical lifetime for AC1:	0.7x 10 ⁵	1x 10 ⁵
Output indication:	yellow LED	2x yellow LED
Communication		
Installation BUS:	BUS	
Power supply		
Supply voltage / tolerance:	27 V DC, -20 / +10 %	
Dissipated power:	max. 4 W	
Rated current:	30 mA (at 27V DC)	50 mA (at 27V DC)
Status indication unit:	green LED RUN	
Connection		
Data terminals:	terminal, 0.5 - 1 mm ²	
Power outputs:	2x conduct. CY, Ø 2.5 mm ²	6x conduct. CY, Ø 0.75 mm ²
Operating conditions		
Operating temperature:	-20 .. +55 °C	
Storage temperature:	-30 .. +70 °C	
Protection degree:	IP30	
Overvoltage category:	II.	
Pollution degree:	2	
Operating position:	any	
Installation:	into installation box	
Dimensions and weight		
Dimensions:	49 x 49 x 21 mm	
Weight:	50 g	50 g

Connection

SA3-01B

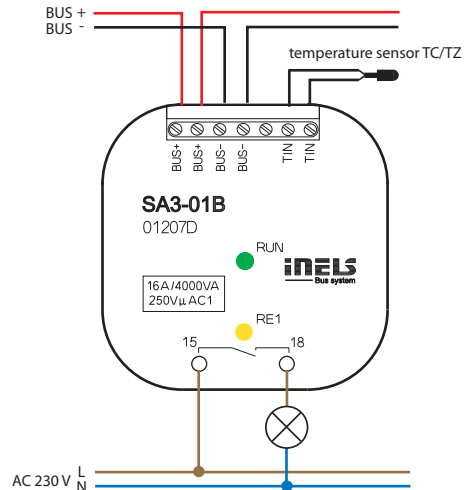

SA3-02B

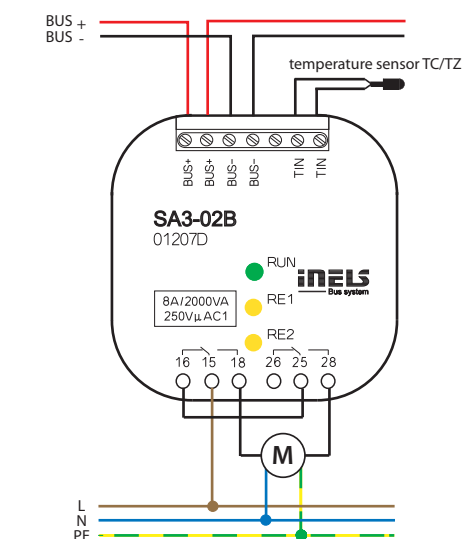

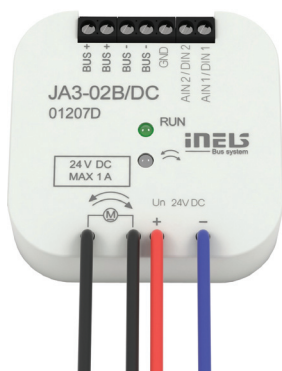

EAN code
JA3-02B/DC: 8595188132718

Technical parameters		JA3-02B/DC
Inputs		
Inputs:		2x AIN/DIN
Resolution:		bit 10
Ext. temperature sensor:		the connection between AIN1/DIN1 and AIN2/DIN2
Type of ext. sensor:		TC/TZ
Temperature measurement range:		-20°C to +120°C
Temperature measurement accuracy:		0.5°C from range
Outputs		
Insulative voltage between outputs and internal circuits:		3.75 kV, SELV by EN 60950
Rated current:		0.85 A*
Peak current:		1.5 A / < 3s
Switched voltage:		12-24 V DC
Output indication UP, (▲):		red (orange) LED
Output indication DOWN, (▼):		green LED
Communication		
Installation BUS:		BUS
Power supply		
Supply voltage / tolerance:		27 V DC, -20 / +10 %
Dissipated power:		max. 1 W
Rated current:		60mA (at 27V DC), from BUS
Status indication unit:		green LED RUN
Connection		
Data terminals:		terminal 0.5 - 1 mm ²
Power outputs:		4x conductor CY, 0.75 mm ²
Operating conditions		
Operating temperature:		-20 to +50°C
Storage temperature:		-30 to +70°C
Protection degree:		IP30
Control device purpose:		operative control device
Control device construction:		individual control device
Characteristics of automatic operation:		1.B.E
Heat and fire resistance category:		FR-0
Anti-shock category (immunity):		class 2
Rated impulse voltage:		2.5 kV
Overvoltage category:		II.
Pollution degree:		2
Operation position:		any
Installation:		into an installation box
Dimensions and weight		
Dimensions:		49 x 49 x 13 mm
Weight:		32 g

* Maximal operation time of outputs with rated current 0.85 A is 10 minutes... after that the output heating protection activates. The lower the current, the longer duration of protection.

- JA3-02B/DC actuator serves to control blinds, shutters, garage doors, entrance gates, etc.
- Operates electrical motors, which are controlled in 2 directions and have a built-in limit switch.
- JA3-02B/DC controls electric drives with supply voltages up to 24 V DC, where the direction of rotation of the driver is controlled by changing the voltage polarity of the motor.
- The unit is equipped with thermal and overcurrent overload protection outputs.
- Status of units is indicated by green LED RUN on the front panel:
 - with the supply voltage connected (through BUS) and the unit is not controlled by BUS, LED RUN shines.
 - with the supply voltage connected (through BUS) and the unit is controlled by BUS, LED RUN flashes.
- Status of output contacts UP/DOWN (▲/▼):
 - while contact UP (▲) is switched, red LED shines (orange).
 - while contact DOWN (▼) is switched, green LED shines.
- The unit is also equipped with two analog digital inputs (AIN/DIN), which can be used to connect two potential free contacts (e.g. to connect double button for local control) or a single external temperature sensor TC/TZ (see accessories).
- JA3-02B/DC is designed for mounting into an installation box.

Connection

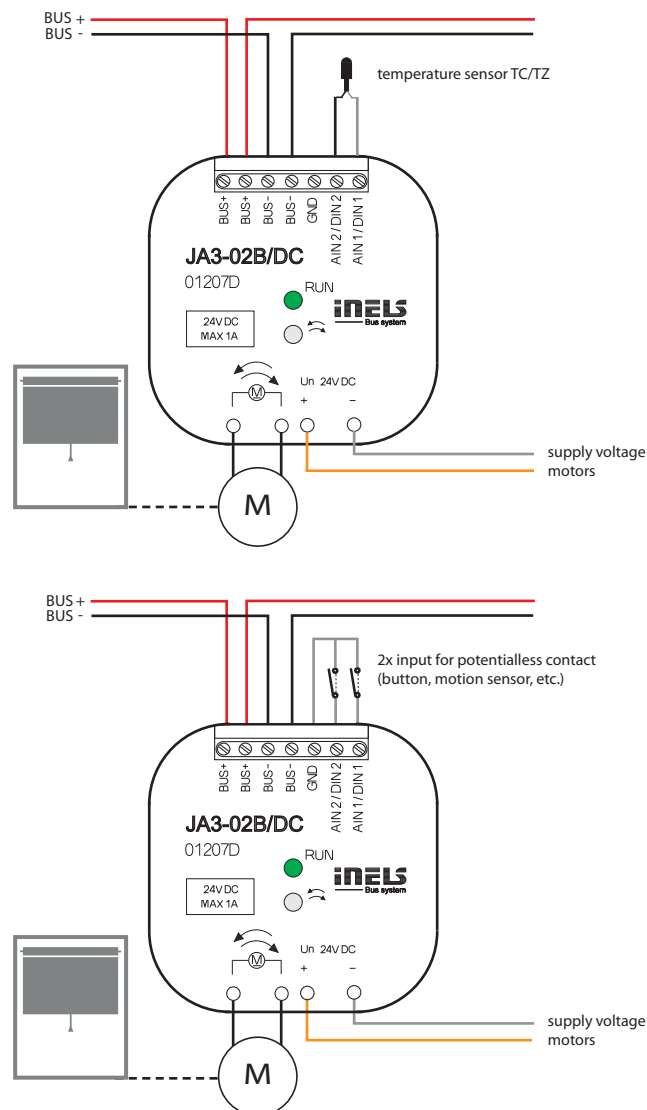



EAN code
JA3-018M: 8595188174466
JA3-018M/120V: 8595188174473

- JA3-018M is an actuator designed for control of roller shutters, blinds, awnings, garage doors, entrance gates, etc.
- It controls electric drives that are controlled in two directions and have a built-in limit switch.
- The unit's status is indicated by the green RUN LED on the front panel
 - If the power supply is connected, but there is no communication via BUS with master, the LED RUN is on continuously.
 - If the supply voltage is connected and the unit communicates by BUS, the LED RUN flashes.
- The status of the output contacts is indicated by the U / D LED:
 - If the roller blinds / blinds go up, the red LED lights up.
 - If the roller blinds / blinds go down, the green LED lights up.
- JA3-09M in 6-MODULE version is designed for mounting into a switchboard on DIN rail EN60715.

Technical parameters JA3-018M JA3-018M/120V

Outputs

Output:	9x changeover 4 A/AC15
Switched voltage:	250 V AC, 24 V DC
Switched output:	1000 W/AC15, 100 W/DC
Peak current:	10 A
Output relays separated from all internal circuits:	basic insulated. (Cat. III surges by EN 60664-1)
Isolation between relay outputs GATE1, GATE2 and GATE3:	basic insulated. (Cat. II surges by EN 60664-1)
Isolates. voltage open relay contact:	1 kV
Minimal switched current:	100 mA / 10 V DC
Switching frequency without load:	300 min ⁻¹
Switching frequency with rated load:	15 min ⁻¹
Mechanical life:	1x 10 ⁷
Electrical life AC1:	1x 10 ⁵
Output indication:	9x yellow LED

Communication

Installation BUS:	BUS
Status indication unit:	green LED RUN

Power supply

Supply voltage by BUS / tolerance / nominal current:	27V DC, -20 / +10 %, 5mA	
Supply voltage of power section (relay tolerance / nominal current:	AC 230V (50 Hz), -15 / +10 %, 20 mA	AC 120V (60 Hz), -15 / +10 %, 40 mA

Connection

Terminal:	max. 2.5 mm ² /1.5 mm ² with sleeve
-----------	---

Operating conditions

Operating temperature:	-20 to +35 °C
Storing temperature:	-30 to +70 °C
Protection degree:	IP20 device, IP40 mounting in the switchboard
Overvoltage category:	II.
Pollution degree:	2
Operating position:	vertical
Installation:	switchboard on DIN rail EN 60715
Design:	6-MODULE

Dimensions and weight

Dimensions:	90 x 105 x 65 mm
Weight:	357 g

Connection

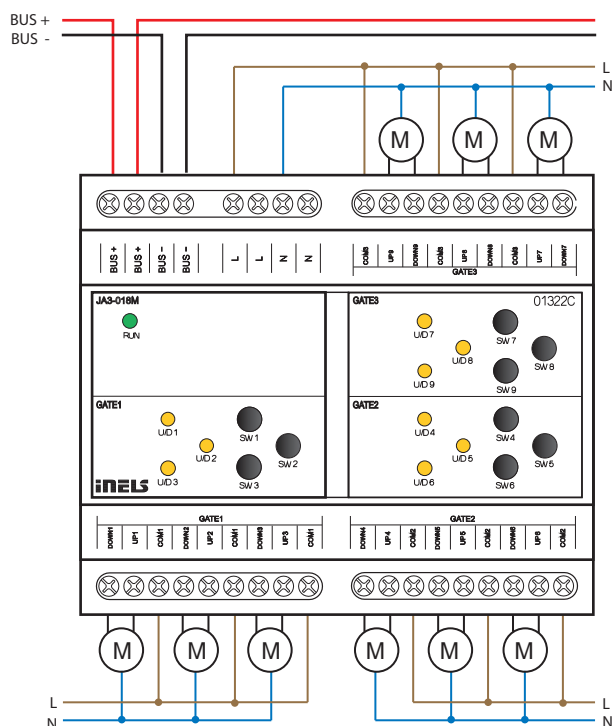



EAN code
DA3-22M: 8595188132626
DA3-22M/120V: 8595188133036

Technical parameters	DA3-22M	DA3-22M/120V
Inputs		
Input:	2x inputs, switching potential L*	
Temperature measuring:	YES, input for external thermo sensor TC/TZ	
Scope and accuracy of temp. measurement:	-20 to +120°C; 0.5°C from the range	
Number of control buttons:	2x buttons 4x potentiometers on front panel	
Outputs		
Output:	2x contactless outputs, 2x MOSFET	
Load type:	resistive, inductive, capacitive**, LED, ESL	
Isolation BUS separated from all internal circuits:	reinforced insulation (Cat. II surges by EN 60664-1)	
Isolation voltage between particular power:	max. 500 V AC	
Minimal controlled load:	10 VA	
Maximal controlled load:	400 VA for each channel	200 VA for each channel
Output indication ON/OFF:	2x yellow LED	
Device protection:	thermal / short-term overload / long-term overload	
Communication		
Installation BUS:	BUS	
Power supply		
Supply voltage by BUS / tolerance:	27 V DC, -20 / +10 %	
Rated current:	5 mA (at 27V DC), from BUS	
Status indication unit:	green LED RUN	
Supply voltage for power section / tolerance:	AC 230V (50Hz), -15 / +10 %	AC 120V (60Hz), -15 / +10 %
Dissipated power:	max. 13 W	max. 7.5 W
Connection		
Terminal:	max. 2.5 mm ² /1.5 mm ² with sleeve	
Operating conditions		
Air humidity:	max. 80 %	
Operating temperature:	-20 to +35 °C	
Storing temperature:	-30 to +70 °C	
Protection degree:	IP20 device, IP40 mounting in the switchboard	
Overvoltage category:	II.	
Pollution degree:	2	
Operating position:	vertical	
Installation:	switchboard on DIN rail EN 60715	
Design:	3-MODULE	
Dimensions and weight		
Dimensions:	90 x 52 x 65 mm	
Weight:	170 g	

* The inputs are not galvanically isolated from the supply voltage.
 ** Attention: It is not allowed to connect loads of inductive and capacitive character, at the same time.
 ⚠ Input is connected to the mains voltage potential.

- DA3-22M is a universal dimming 2-fold actuator enabling control of brightness intensity of dimmable light sources of the type ESL, LED and RLC with power supply 230 V.
- DA3-22M has two MOSFET controlled outputs 230 V AC, maximum load is 2x 400 VA.
- Option of connecting an external temperature sensor.
- Each output channel is independently controllable and addressable.
- Type of light source is set by a switch on the front panel.
- By setting the min. brightness potentiometer on the front panel, flashing of different types of light sources is eliminated.
- DA3-22M is equipped with two inputs 230 V AC, which can be controlled by mechanical switches (buttons, relays). Inputs are galvanically connected to potential L, which is permanently at the terminals IN1 and IN2.
- Buttons on the front panel, you can manually switch on or off the corresponding output.
- Electronic overcurrent and thermal protection - switch off output in case of overload short circuit and overheating.
- The power supply (potential L) must be protected by a protective element corresponding to the power input of the connected load, e.g. a safety fuse.
- During installation, it is necessary to leave on each side of the actuator at least half the module space for better cooling.
- DA3-22M in 3-MODULE version is designed for mounting into a switchboard on DIN rail EN60715.

Connection

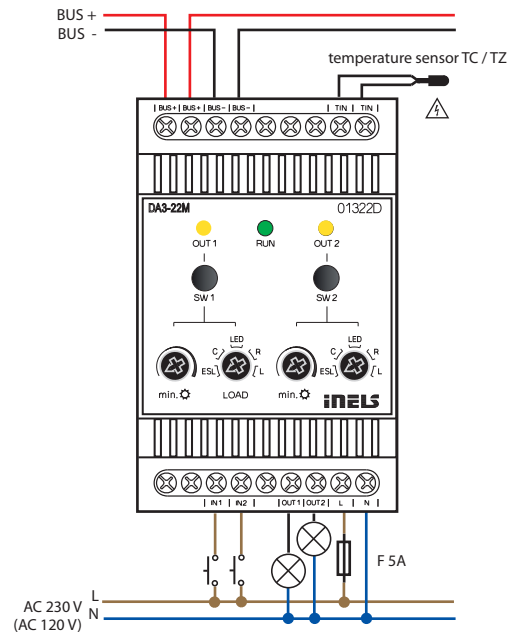

Types of connectable loads

type of source	symbol	description
R resistive		ordinary light bulb, halogen lamp
L inductive		coiled transformer for low-voltage halogen lamps
C capacitive		electronic transformer for low-voltage halogen lamps
LED		LED lamps and LED light sources, 230 V
ESL		dimnable energy-saving fluorescent tubes

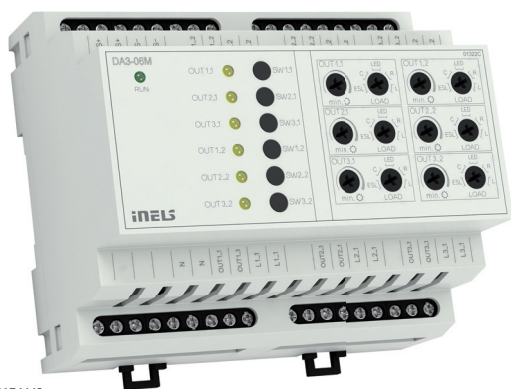

EAN code
DA3-06M: 8595188174442
DA3-06M/120V: 8595188174459

Technical parameters DA3-06M DA3-06M/120V

Outputs	
Output:	6x contactless outputs, 2x MOSFET, channel
Load type:	resistive, inductive, capacitive*, LED, ESL
Isolation BUS separated from all internal circuits:	reinforced Insulation (Cat. II surges by EN 60664-1)
Isolation voltage between particular power:	max. 500 V AC
Minimal controlled load:	10 VA
Maximal controlled load:	DA3-06M (230V): 150 VA for each channel DA3-06M/120V: 75 VA for each channel
Output indication ON/OFF:	6x yellow LED
Device protection:	thermal / short-term overload / long-term overload / short circuit
Communication	
Installation BUS:	BUS
Power supply	
Supply voltage by BUS / tolerance:	27 V DC, -20 / +10 %
Rated current:	100 mA (at 27V DC), from BUS
Status indication unit:	green LED RUN
Supply voltage for power section / tolerance:	3x AC 230 V (50 Hz), -15 / +10 % 3x AC 120 V (60 Hz), -15 / +10 %
Connection	
Terminal:	max. 2.5 mm ² /1.5 mm ² with sleeve
Operating conditions	
Air humidity:	max. 80 %
Operating temperature:	-20 to +35 °C
Storing temperature:	-30 to +70 °C
Protection degree:	IP20 device, IP40 mounting in the switchboard
Overvoltage category:	II.
Pollution degree:	2
Operating position:	vertical
Installation:	switchboard on DIN rail EN 60715
Design:	6-MODULE
Dimensions and weight	
Dimensions:	90 x 105 x 65 mm
Weight:	320 g

* Attention: It is not allowed to connect loads of inductive and capacitive character, at the same time.

- DA3-06M is a universal six-channel dimmer actuator that controls the brightness of dimmable ESL, LED and RLC light sources with 230V power.
- The DA3-06M has 6 semiconductor controlled 230 V AC outputs. Maximum possible load is 150 VA for each channel.
- Each of the output channels is individually controllable.
- Setting min. Brightness with the potentiometer on the front of the instrument eliminates flickering of different types of light sources.
- Using the front panel control buttons, you can manually control the output.
- The actuator is equipped with electronic overcurrent and thermal protection that shuts off the output during overloads, short circuits or overheating.
- When installing, on each side of the actuator, it is necessary to leave at least half a module space for better cooling.
- DA3-06M in 6-MODULE version is designed for mounting into a switchboard/ DIN rail EN60715.

Connection

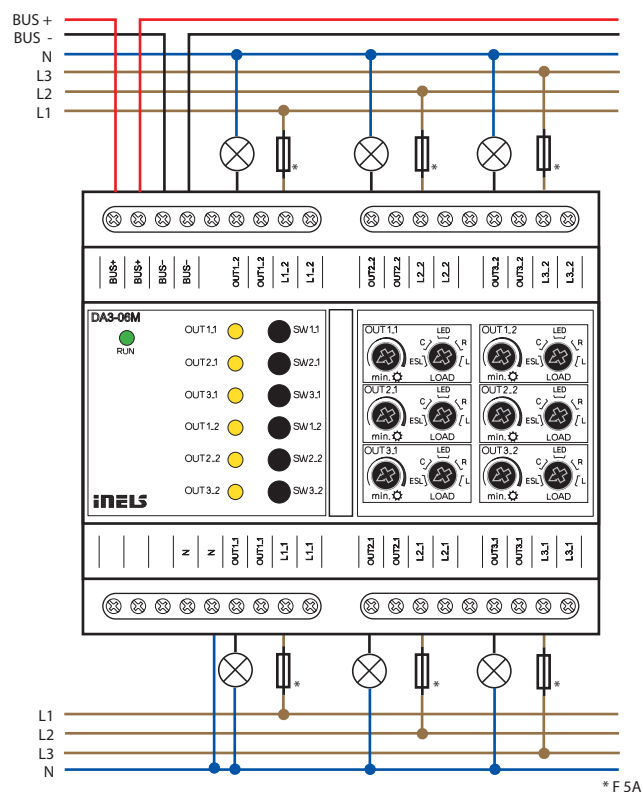

Types of connectable loads

type of source	symbol	description
R resistive		ordinary light bulb, halogen lamp
L inductive		coiled transformer for low-voltage halogen lamps
C capacitive		electronic transformer for low-voltage halogen lamps
LED		LED lamps and LED light sources, 230 V
ESL		dimmable energy-saving fluorescent tubes



EAN code
LBC3-02M: 8595188132688

- LBC3-02M is an analog two-channel actuator designed to control dimmable ballasts of fluorescent lamps or other light sources controlled by signal 0(1) - 10 V DC.
- In the iDM3, it is possible to set the output mode 0(1) - 10 V DC.
- During analog voltage output (0)1-10 V DC control, relay contact automatically switches power supply to light ballast (0% = relay OFF, 1-100% = relay ON)
- LBC3-02M contains 2 independent analog voltage outputs (0)1-10 V DC and their dependents 2 relays with potential-free contact.
- Maximum contacts load 16 A/4000 VA/AC1.
- Each of two channels is separately controllable and addressable.
- LEDs on front panel signals status of each channel.
- With control buttons on the front panel, it is possible to change the status of each channel separately.
- LBC3-02M in 3-MODULE version is designed for mounting into a switchboard/ DIN rail EN60715.

Technical parameters		LBC3-02M
Inputs		
Number of control buttons:	2 buttons on the front panel	
Outputs		
Output:	2x 0(1)-10 V/10 mA 2x changeover 16 A/AC1	
Switching voltage:	250 V AC1, 24 V DC	
Switching capacity:	4000 VA/AC1, 384 W/DC	
Peak current:	30 A; max. 4 s. at duty cycle 10%	
Insulation voltage between individual relay outputs RE1aRE2 and internal circuits:	4 kV reinforced Insulation (Cat. II surges by EN 60664-1)	
Isolates. voltage open relay contact:	1 kV	
Minimal switched current:	100 mA	
Frequency of switching/no load:	1200 min ⁻¹	
Frequency of switching/rat. load:	6 min ⁻¹	
Mechanical life:	3x 10 ⁷	
Electrical life AC1:	0.7x 10 ⁵	
Output indication:	2x yellow LED	
Communication		
Installation BUS:	BUS	
Power supply		
Supply voltage / tolerance:	27 V DC, -20 / +10 %	
Dissipated power:	max. 2 W	
Rated current:	60 mA (at 27V DC), from BUS	
Status indication unit:	green LED RUN	
Connection		
Terminal:	max. 2.5 mm ² /1.5 mm ² with sleeve	
Operating conditions		
Air humidity:	max. 80 %	
Operating temperature:	-20 to +55 °C	
Storing temperature:	-30 to +70 °C	
Protection degree:	IP20 device, IP40 mounting in the switchboard	
Overvoltage category:	II.	
Pollution degree:	2	
Operating position:	any	
Installation:	switchboard on DIN rail EN 60715	
Design:	3-MODUL	
Dimensions and weight		
Dimensions:	90 x 52 x 65 mm	
Weight:	134 g	

Connection

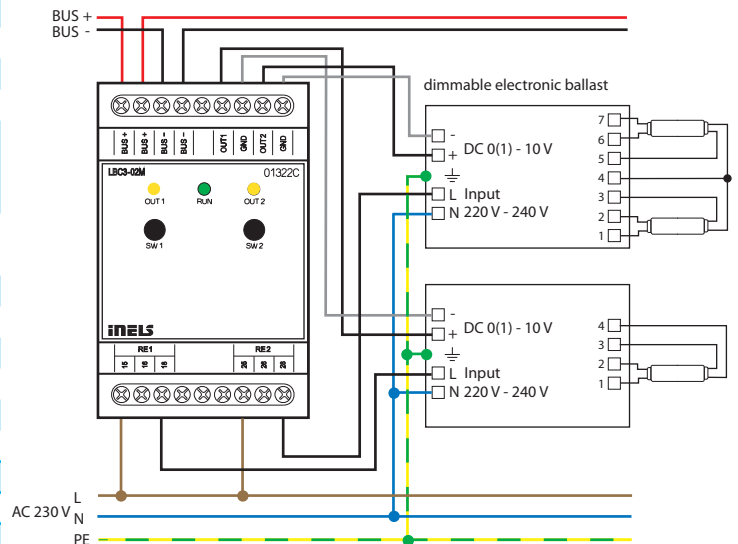



EAN code

RFDA-73M/RGB (866 MHz): 8595188157667

RFDA-73M/RGB (868.5MHz): 8595188146814

RFDA-73M/RGB (868.1 MHz): 8595188144179

RFDA-73M/RGB (916 MHz): 8595188153003

RFDA-73M/RGB (922 MHz): 8595188158312

Technical parameters**RFDA-73M/RGB****Outputs**

Dimmed load:	LED strip 12V,24V with common anode; RGB LED strips 12V, 24V with common anode
Number of channels:	3
Rated current:	3x 5 A
Peak current:	3x 10 A
Switching voltage:	Un

Controlling

RF by command from the transmitter:	866 MHz / 868 MHz / 916 MHz
Ext. signal:	0-10 V, 1-10V
Range in open space:	up to 160 m
Output for RF antenna:	SMA connector *
Load capacity of output +10 V:	10 mA

Power supply

Supply terminals:	Un+, GND
Supply voltage:	12-24 V DC stabilized
Max. power without load:	0.8 W

Connection

Terminal:	max 1x2.5, max 2x1.5/ with sleeve max. 1x2.5 mm ²
-----------	--

Operating conditions

Operating temperature:	-20 up to + 50 °C
Storing temperature:	-30 up to + 70 °C
Pollution degree:	2
Operating position:	any
Protection:	IP20 device, IP40 mounting in the switchboard
Installation:	into a switchboard rail to DIN EN 60715
Design:	3-MODULE

Dimensions and weight

Dimensions:	90 x 52 x 65 mm
Weight:	130 g

* Max Tightening Torque for antenna connector is 0.56 Nm.

Attention:

The minimum distance between the controller (system unit) and the actuator must not be less than one centimeter.

Between the individual commands must be an interval of at least 1s.

- The dimmer for LED strips is used for independent control of 3 single-color LED strips or one RGB LED strip.
- The expanded selection of control modes enables it to be combined with:
 - Controllers and System units iNELS RF Control
 - control signal 0(1) - 10 V
 - connecting to iNELS BUS using DAC converters.
- The unit's three-module design with switchboard mounting enables connection of dimmed load 3 x 5A, which represents:
 - single-color LED strip 7.2W (ELKO Lighting) – 3 x 8 m
 - RGB LED strip 14.2 W (ELKO Lighting) – 10 m.
- 6 light functions - smooth increase or decrease with time setting 2s - 30 min.
- When switched off, the set level is stored in the memory, and when switched back on, it returns to the most recently set value.
- The dimmer may be controlled by up to 25 channels (1 channel represents 1 button on the controller).
- The power supply of the unit is in the range of 12 - 24 V DC, and is indicated by a green LED.
- The package includes an internal antenna AN-I, in case of locating the unit in a metal switchboard, you can use the external antenna AN-E for better signal reception.
- Range up to 160 m (in open space), if the signal is insufficient between the controller and unit, use the signal repeater RFRP-20 or protocol component RFIO² that support this feature.
- For components labelled as iNELS RF Control² (RFIO²), it is possible to set the repeater function via the RFAF / USB service device.
- Communication frequency with bidirectional protocol iNELS RF Control² (RFIO²).

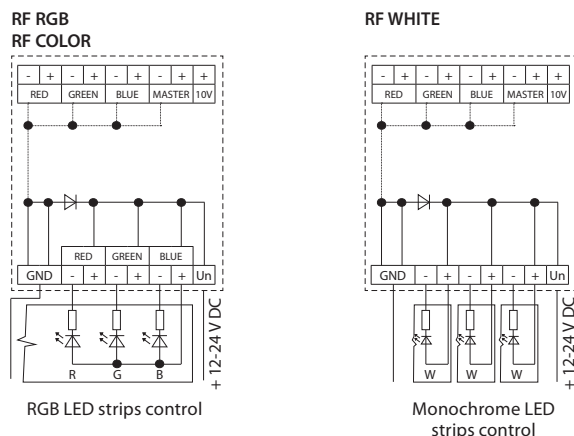
Connection**Output variations**

RGB LED strips control

Monochrome LED strips control

Control modes

RF RGB

Switch settings in MODE:

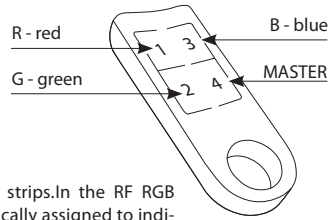
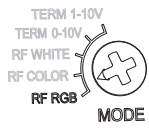

RF RGB mode for controlling RGB LED strips. In the RF RGB programming mode, colors are automatically assigned to individual transmitter buttons.

Note:

The mode can be controlled by RF Touch, RF Pilot, RFWB-40/G, RF KEY, RFIM-40B, eLAN-RF-003 and eLAN-RF-Wi-003

RF COLOR

Switch settings in MODE:

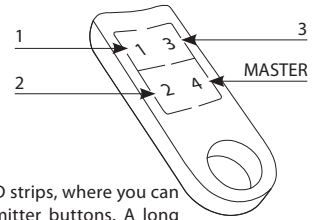
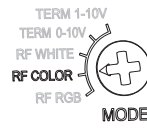

RF COLOR mode for controlling RGB LED strips, where you can choose the color for individual transmitter buttons. A long press of the button starts the color search mode. After releasing the button, the current color is set for the given button.

Note:

The mode can be controlled by RF Touch, RF Pilot, RFWB-40/G, RF KEY RFIM-40B, eLAN-RF-003 and eLAN-RF-Wi-003.

RF WHITE

Switch settings in MODE:

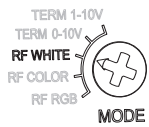

This works in a mode where it acts like three independent dimmers for 12-24V. Each channel can be programmed independently of one another and has its own address.

Note:

The mode can be controlled by RF Touch, RF Pilot, RFWB-20/G, RFWB-40/G, RF KEY, RFIM-20B, RFIM-40B, eLAN-RF-003 and eLAN-RF-Wi-003.

TERM 0-10V and TERM 1-10V

Switch settings in MODE:

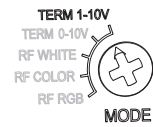
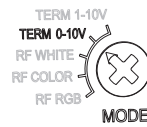

Modes TERM 0-10V and TERM 1-10V. Inputs 0-10V and 1-10V used to control one RGB LED strip or three independent single-color LED strips from the iNELS BUS System. For controlling, you can use the application iMM on the TV screen or the application iHC for smartphones and tablets.

Control options of monochromatic RGB LED strips from iNELS BUS System

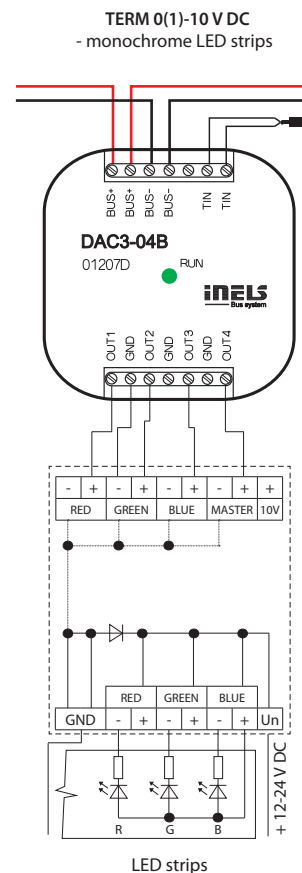
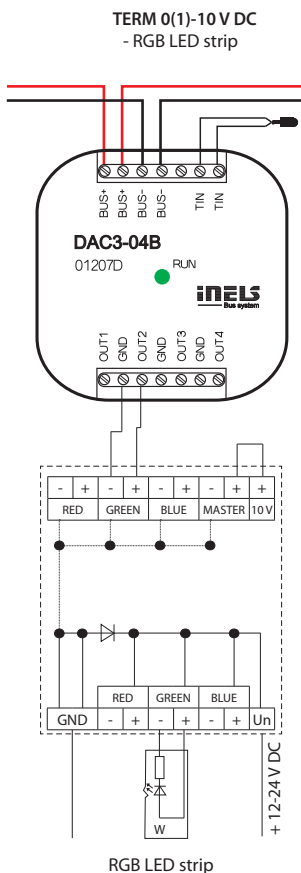



EAN code
DCDA-33M: 8595188146807

- DCDA-33M is a dimming unit designed to dim single-color and RGB LED light sources controlled by variable current.
- The actuator has three independent channels and each output channel is individually addressable and controllable.
- DCDA-33M actuator can be controlled from the BUS, DALI or DMX.
- When controlling the unit from the BUSES and DMX, also the fourth virtual channel can be supported to control overall brightness (BUS – set in iDM3, DMX – set by long press of the PRG button).
- DCDA-33M can directly control from the system iNELS where the communication interface is the installation BUS.
- If for controlling, a communication interface DALI or DMX is used, it is possible to use the master unit EMDC-64M.
- The supply voltage of the dimming unit must be at least 4V higher than the expected output voltage on the load.
- Setting the communication interface and addresses of actuators is performed using DIP switches:
 - switch No. 1
 - In the upper position determines DALI or BUS
 - In the lower position determines DMX
 - switch No. 2 (if that switch 1 is in the upper position)
 - In the upper position determines DALI
 - In the lower position determines BUS
- Using the control buttons on the front panel, you can manually control the output.
- The input circuits of communication interfaces are optically isolated from the supply voltage connected lamp unit, and is therefore resistant to electromagnetic interference.
- DCDA-33M in 3-module is designed for panel mounting on DIN rail EN60715.

Technical parameters	DCDA-33M
Power supply	
Supply terminals:	Un+, GND
Supply voltage:	12 - 60 V
Consumption:	min. 0.5 W, max. 165 W
Supply voltage from BUS / tolerance:	27V DC, -20 / +15 %
Dissipated power:	max. 2 W
Outputs	
Dimming load:	LED chips controlled by variable streams or alternatively multiple LED chips connected in series*
Number of channels:	3
Rated current:	350 mA - 2 A
Output power:	3x 50 W
Output voltage:	6.5 - 55 V
Switching voltage:	Un
Output indication	LED OUT1, OUT2, OUT3
- light:	ON
- short:	flashing
- no light:	OFF
Control	
DALI:	1200 bit/s, 250 mA
BUS:	compatible with iNELS3, consumption < 4 mA
DMX:	250 kbit/s, 512 channels, control RGB(M) 3(4) channels
Operating conditions	
Relative humidity:	max. 80 %
Operating temperature:	-20°C to +55°C
Storage temperature:	-30°C to +70°C
Protection degree:	IP20 device, IP40 mounitg in the switchboard
Overvoltage category:	II.
Pollution degree:	2
Operating position:	vertical
Installation:	into switchboard on DIN rail EN60715
Implementation:	3-MODULE
Dimensions and weight	
Dimensions:	90 x 52 x 65 mm
Weight:	135g

* for more information, see our manual.

Connection

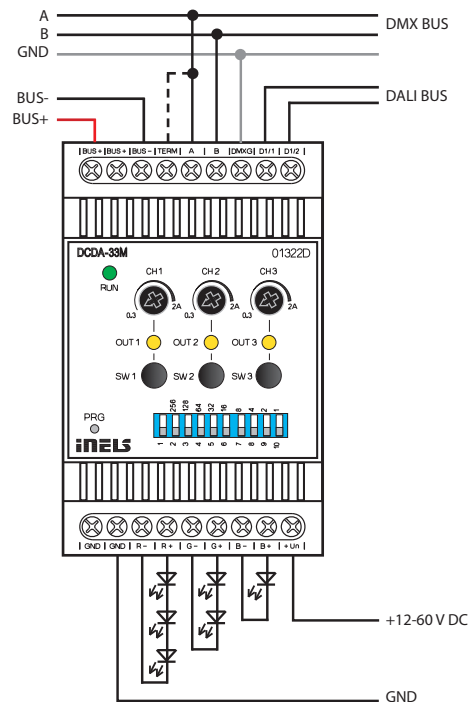

Setting the DIP switches

Setting the DALI communication interface - Switch 1 and 2.

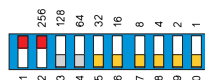

Setting the BUS communication interface - Switch 1 and 2.



Setting the DMX communication interface - Switch 1.
Setting address - Switch 2-10.





EAN code
IM3-140M: 8595188132459

Technical parameters		IM3-140M
Inputs		
Input:	14x NO or NC against GND (-) IN1 - IN7 -are balanced inputs	
Max. frequency pulse reading:	20 Hz	
Outputs		
Output (power supply 12V for sensors):	12 V DC/150 mA	
Communication		
Installation BUS:	BUS	
Data transfer indication:	green LED	
Power supply		
Supply voltage / tolerance:	27 V DC, -20 / +10 %	
Dissipated power:	max. 1 W	
Rated current:	25 mA (at 27V DC), from BUS	
Rated current for full load on output 12 V DC:	100 mA	
Connection		
Terminal:	max. 2.5 mm ² /1.5 mm ² with sleeve	
Operating conditions		
Air humidity:	max. 80 %	
Operating temperature:	-20 .. +55 °C	
Storing temperature:	-30 .. +70 °C	
Protection degree:	IP20 device, IP40 mounting in the switchboard	
Overvoltage category:	II.	
Pollution degree:	2	
Operating position:	any	
Installation:	into a switchboard rail to DIN EN 60715	
Design:	3-MODULE	
Dimensions and weight		
Dimensions:	90 x 52 x 65 mm	
Weight:	104 g	

- Binary input unit IM3-140M is designed to connect up to 14 devices with potentialless contact (such as switches, buttons of other designs, fire and glass detectors and others).
- Inputs IN1 - IN7 can be balanced.
- Contacts of external devices connected to the inputs of the drive can be NO or NC - Input parameters are configured in the software iDM3.
- Inputs must be configured as balanced or double balanced - in an internal Electronic security system configured in iDM3 software.
- The unit generates a supply voltage of 12 V DC / 150 mA for powering external detectors, so it can power PIR detectors, fire and gas detectors.
- Active use 12 V DC output for powering detectors increases the nominal consumption units from BUS (see technical data).
- The unit can be used for counting pulses of energy meters with pulse output.
- IM3-140M in 3-module is designed for switchboard mounting on DIN rail EN60715.

Connection

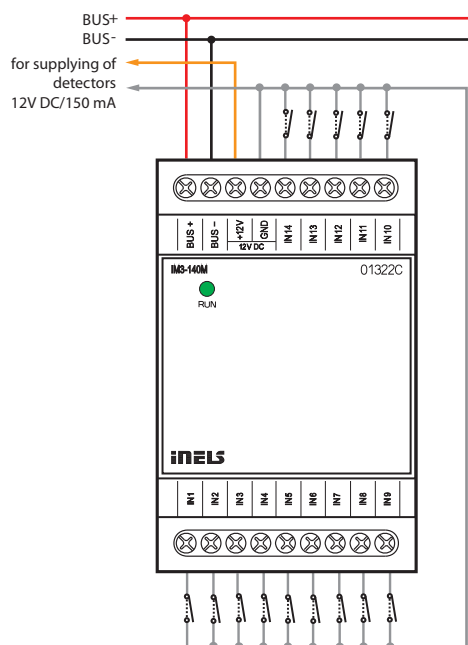

Balanced input

Simple:

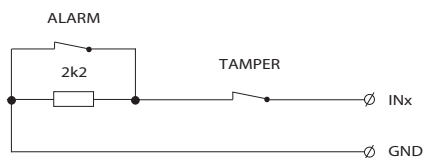

Double:

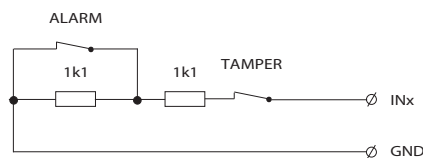

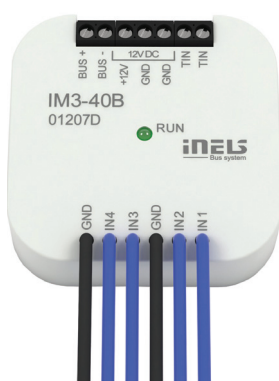

EAN code
 IM3-20B: 8595188132305
 IM3-40B: 8595188132312
 IM3-80B: 8595188132329

Technical parameters			
	IM3-20B	IM3-40B	IM3-80B
Inputs			
Input:	2x*	4x*	8x*
	IN1, IN2**	IN1, IN2**	IN1 - IN5**
Max. frequency pulse reading:	20 Hz		
Temperature measuring:	Yes, input for external thermo sensor TC/TZ		
Range /accuracy of thermomeasuring:	-20 to +120°C / 0.5°C from the range		
Outputs			
Output voltage / current:	12 V DC/75 mA, for supplying EZS sensors		
Communication			
Installation BUS:	BUS		
Status indication unit:	green LED RUN		
Power supply			
Supply voltage / tolerance:	27 V DC, -20 / +10 %		
Dissipated power:	max. 1 W		
Rated current:	20 mA (at 27V DC), from BUS		
Rated current of unit for full load on output 12 V DC:	60 mA		100 mA
Connection			
Terminal:	0.5-1 mm ²		
Inputs:	4x conductors CY, profile 0.75mm ² , length 90mm	6x conductors CY, profile 0.75mm ² , length 90mm	x
Operating conditions			
Operating temperature:	-20 to +55 °C		
Storing temperature:	-30 to +70 °C		
Protection degree:	IP30		
Overvoltage category:	II.		
Pollution degree:	2		
Operating position:	any		
Installation:	into installation box		
Dimensions and weight			
Dimensions:	49 x 49 x 13 mm		
Weight:	30 g	32 g	27 g

* NO or NC against GND(-)

** are balanced inputs

- Binary input units IM3-20B, IM3-40B and IM3-80B are used for connection of 2, 4 or 8 devices with potential-less contacts (switches, buttons, switches of other design, PIR detectors, fire and gas detectors, etc.).
- Part of the inputs can be used as a balanced for alarm detectors:
 - IM3-20B – inputs IN1, IN2
 - IM3-40B – inputs IN1, IN2
 - IM3-80B – inputs IN1 – IN5.
- Contacts of external devices connected to the inputs of the unit can be NO or NC - Input parameters are configured in the software iDM3.
- Within the internal EZS configured in the iDM3 software, inputs must be set to balance or double balance.
- The units generate a supply voltage of 12V DC / 75 mA for powering external intrusion detectors, so they can power PIR detectors, fire and gas detectors.
- Active use 12 V DC output for powering detectors increases the nominal consumption of units from BUS (see technical data).
- The units can be used for counting pulses of energy meters with pulse output.
- The units are equipped with a temperature input for connecting an external two-wire temperature sensor TC/TZ (see accessories).
- IM3-20B, IM3-40B, IM3-80B in case type B are designed for mounting into a installation box.

Connection

IM3-20B

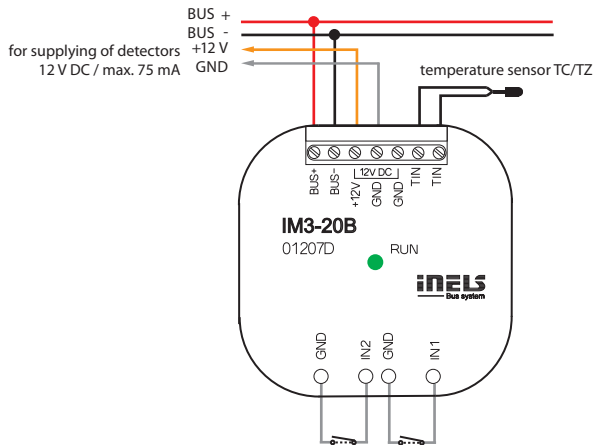

IM3-40B

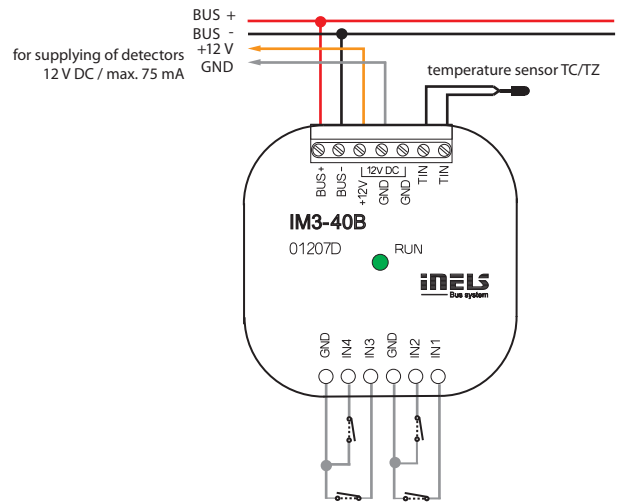

IM3-80B

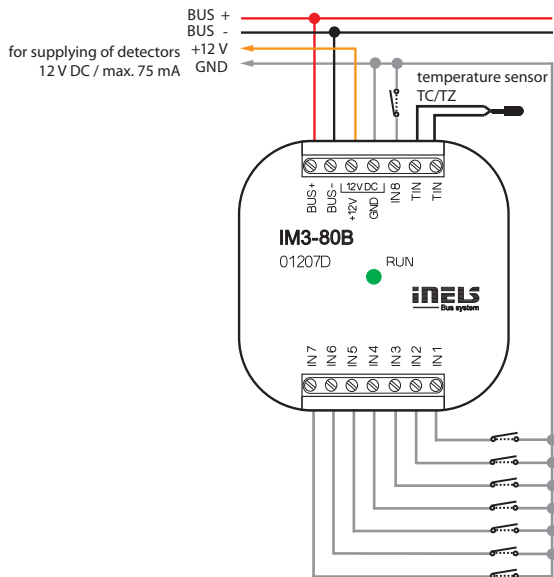

Balanced input

Simple:

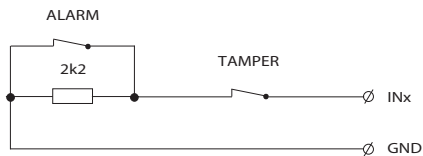

Double:

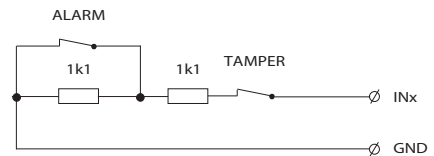



EAN code
 TI3-10B: 8595188132886
 TI3-40B: 8595188132695

Technical parameters	TI3-10B	TI3-40B
Input		
Temperature input for temperature measuring:	1x inputs for external thermo sensor *	4x inputs for external thermo sensor*
Temperature measurement range:	by type of sensor, prob from -50°C to 400°C	
Converter resolution:	15 bit	
Communication		
Installation BUS:	BUS	
Status indication unit:	green LED RUN	
Power supply		
Supply voltage / tolerance:	27 V DC, -20 / +10 %	
Dissipated power:	max. 1 W	
Rated current:	20 mA (at 27V DC), from BUS	
Connection		
Terminal:	0.5 mm ² - 1 mm ²	
Operating conditions		
Operating temperature:	-20 .. +55 °C	
Storing temperature:	-30 .. +70 °C	
Protection degree:	IP30	
Overvoltage category:	II.	
Pollution degree:	2	
Operating position:	any	
Installation:	into installation box	
Dimensions and weight		
Dimensions:	49 x 49 x 13 mm	
Weight:	27 g	27 g

*TC, TZ, Ni1000, Pt1000, Pt100, see accessories

Connection options

2-wire
 - it is necessary to connect terminals TIN_B and COM

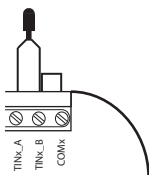

3-wire
 - connection of the sensor needs to be done according to the technical specifications

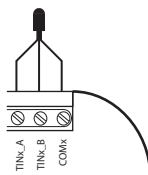

- These units are designed for connection of one (TI3-10B) to four (TI3-40B) external temperature sensors.
- Units range TI3 support the connection of the following temperature sensors:
 - TC / TZ - 2-wire connections
 - Ni1000, Pt1000, Pt100 - 2-wire and 3-wire connections.
- Used in when necessary to take temperatures from different places (for example large floor heating – diagonal layout of sensors, floor/space, indoor/outdoor temperature, technological device – boiler, solar heating etc.)
- Status of units indicated by green RUN LED on the front panel:
 - If the supply voltage is connected (units are powered via the BUS), but there is no communication with the master, RUN LED is lit continuously.
 - If the supply voltage is connected and the unit communicates via standard BUS, RUN LED flashes.
- TI3-10B, TI3-40B in version B is designed for mounting into an installation box.

Connection

TI3-10B

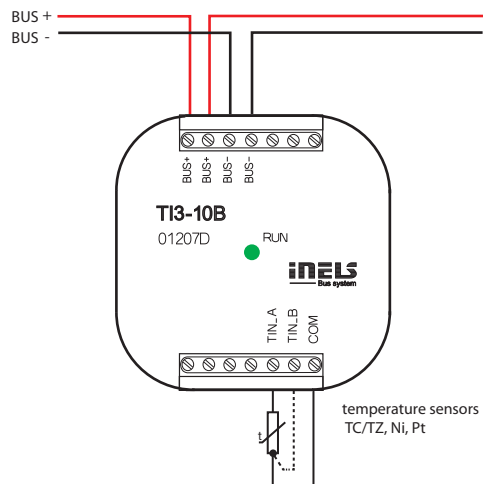

TI3-40B

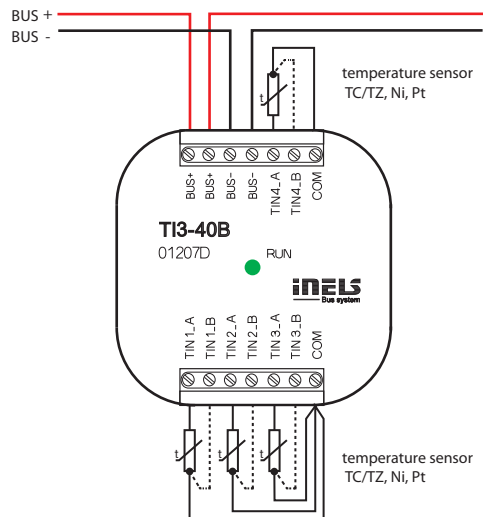



EAN code
TI3-60M: 8595188132893

Technical parameters		TI3-60M
Inputs		
Temperature input for temperature measuring:	6x input for external temperature sensor TC, TZ, Ni1000, Pt1000, Pt100 see accessories	
Temperature measurement range:	by type of sensor, probe from -50°C to 400°C	
Converter resolution:	15 bit	
Indication of exceeding the range or interruption of the sensor:	6x red LED	
Communication		
Installation BUS:	BUS	
Status indication unit:	green LED RUN	
Power supply		
Supply voltage / tolerance:	27 V DC, -20 / +10 %	
Dissipated power:	max. 1 W	
Rated current:	45 mA (at 27V DC), from BUS	
Connection		
Terminal:	max. 2.5 mm ² /1.5 mm ² with sleeve	
Operating conditions		
Operating temperature:	-20 to +55 °C	
Storing temperature:	-30 to +70 °C	
Protection degree:	IP20 device, IP40 mounting in the switchboard	
Overvoltage category:	II.	
Pollution degree:	2	
Operating position:	any	
Installation:	into a switchboard rail to DIN EN 60715	
Design:	3-MODULE	
Dimensions and weight		
Dimensions:	90 x 52 x 65 mm	
Weight:	111 g	

Connection options

2-wire
- it is necessary to connect terminals TIN_B and COM

3-wire
- connection of the sensor needs to be done according to the technical specifications

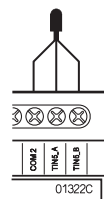
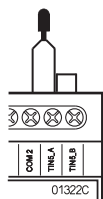

- Unit TI3-60M is designed to connect up to six external temperature sensors.
- Units range TI3 support the connection of the following temperature sensors:
 - TC / TZ - 2-wire connections
 - Ni1000, Pt1000, Pt100 - 2-wire and 3-wire connections.
- It is used in cases where it is necessary to read the temperature, eg floor/room, indoor/outdoor temperature, process equipment - boiler, solar heating, etc.
- Unit status is indicated by green RUN LED on the front panel:
 - If the supply voltage is connected (the unit is powered via the BUS), but there is no communication with the master, RUN LED is lit continuously.
 - If the supply voltage is connected and the unit communicates via standard BUS, RUN LED flashes.
- The status on individual temperature inputs is indicated by the relevant red LED on the front panel:
 - LIT - temperature sensor disconnection
 - FLASHES - exceeding of the temperature range
 - UNLIT - ok.
- TI3-60M in 3-module is designed for switchboard mounting on DIN rail EN60715.

Connection

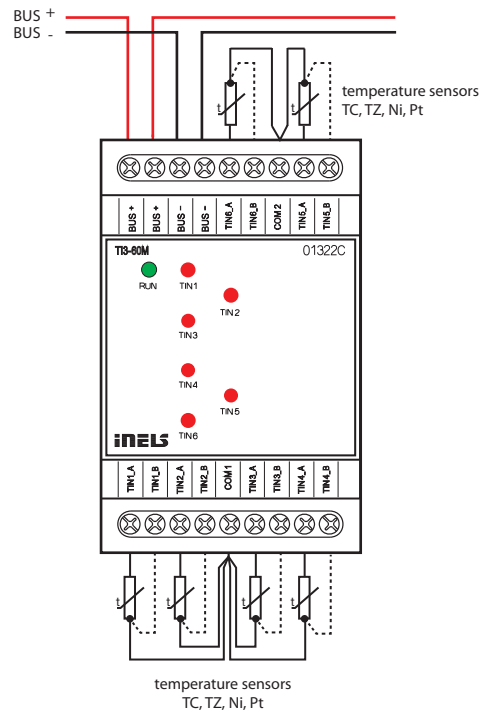



EAN code
ADC3-60M: 8595188133012

- ADC3-60M is an analog-to-digital converter and is equipped with 6 analog inputs.
- Analog inputs serve to connect temperature sensors or analog sensors that generates current or voltage signal.
- The analog inputs have a resolution of a 14-bit AD converter.
- The analog inputs have a common terminal COM.
- Analog inputs / outputs are configurable in iDM3 independently as voltage (U) or current (I) or temperature.
- We recommend Clima sensor as a meteo station. There are four types: five to eight outputs. The top series offers measuring of: rainfall, brightness, twilight, speed of wind, temperature and relative humidity.
- The red LEDs in the front panel indicate exceeding the range, interruption of a sensor or overload of Uref output.
- The temperature inputs at the top of the terminal are used to connect the following temperature sensors: TC, TZ.
- ADC3-60M in 3-MODULE version is designed for mounting into a switchboard, on a DIN rail EN60715.

Technical parameters

ADC3-60M

Input

Analog inputs:	6x voltage, current or temperature input
Number of inputs:	6
Galv. separation from inner circuits:	No
Diagnostic:	indication (exceeding the range, interruption of a sensor or overload of Uref output) by the applicable red LED
Common terminal:	COM
Converter resolution:	14 bits
Input resistance	
- for voltage ranges:	approx. 150 k Ω
- for current ranges:	100 Ω
Types of inputs / measuring ranges*:	Voltage (U): 0 ÷ +10 V (U) ; 0 ÷ +2 V (U) Current (I): 0 ÷ +20 mA (I) ; ÷ +20 mA (I) temperature: input at ext. temperature sensor TC, TZ see accessories / according to used sensor from -40°C to 125°C

Outputs of the Uref1 and Uref2 voltage

Voltage** / current of Uref1:	10 or 15 V DC / 100 mA
Voltage** / current of Uref2:	10 V DC / 20 mA

Communication

Installation BUS:	BUS
Unit status indication:	green LED RUN

Power supply

Supply voltage / tolerance:	27 V DC, -20 / +10 %
Dissipated power:	max. 1 W
Rated current:	100 mA (at 27V DC), from BUS

Connection

Terminal:	max. 2.5 mm ² /1.5 mm ² with sleeve
-----------	---

Operating conditions

Operating temperature:	-20 to +55°C
Storing temperature:	-30 to +70°C
Protection degree:	IP20 device, IP40 mounting in the switchboard
Overvoltage category:	II.
Pollution degree:	2
Operating position:	any
Installation:	into a switchboard rail to DIN EN 60715
Design:	3-MODULE

Dimensions and weight

Dimensions:	90 x 52 x 65 mm
Weight:	112 g

* selectable for each input/output individually by configuration in the user program iDM3. Min. supply voltage 24 V DC must be respected when configuring 15 V DC and 100 mA consumption.

** according to load Uref output.

Connection

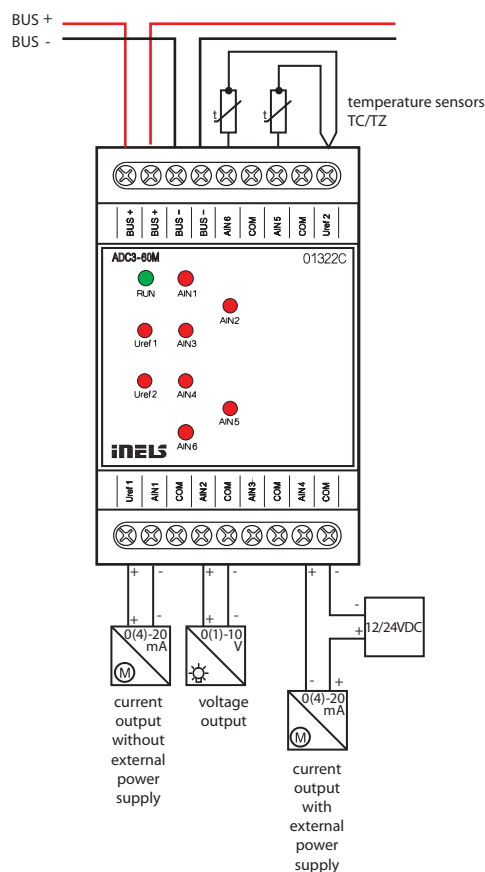



EAN code
DAC3-04M: 8595188132565

- DAC3-04M is a converter from a digital signal to an analog voltage signal.
- The converter generates 4 analog voltage signals, which can be operated, according to type of controlled device, in a range 0-10 V or 1-10 V.
- This is used for regulating and controlling devices that may be controlled by this signal (dimnable ballasts of fluorescent lamps and other types of light sources - e.g. LED panels from the assortment of ELKO Lighting, dimming actuator for LED and RGB strips RFDA-73M/RGB, thermostatic heads, servo drives, elements for measuring and regulation and others).
- Range of output voltage is adjustable in iDM3.
- Converter is equipped with a temperature input for connecting a 2-wire external sensor TC/TZ (see accessories).
- DAC3-04M in 3-MODULE version is designed for mounting into a switchboard, on DIN rail EN60715.

Technical parameters DAC3-04M

Input	
Temperature measuring:	YES, input for external temperature sensor TC/TZ
Range / accuracy of temp. measuring:	-20 to +120°C; 0.5°C from the range
Outputs	
Analog voltage output / rated current:	4x 0(1)-10 V/10 mA
Indication of output overload:	red LED OVERLOAD
Communication	
Installation BUS:	BUS
Status indication unit:	green LED
Power supply	
Supply voltage / tolerance:	27 V DC, -20 / +10 %
Dissipated power:	max. 1 W
Rated current:	50 mA (at 27V DC), from BUS
Connection	
Terminal:	max. 2.5 mm ² /1.5 mm ² with sleeve
Operating conditions	
Air humidity:	max. 80 %
Operating temperature:	-20 to +55 °C
Storing temperature:	-30 to +70 °C
Protection degree:	IP20 device, IP40 mounting in the switchboard
Overvoltage category:	II.
Pollution degree:	2
Operating position:	any
Installation:	switchboard on DIN rail EN 60715
Design:	3-MODULE
Dimensions and weight	
Dimensions:	90 x 52 x 65 mm
Weight:	108 g

Connection

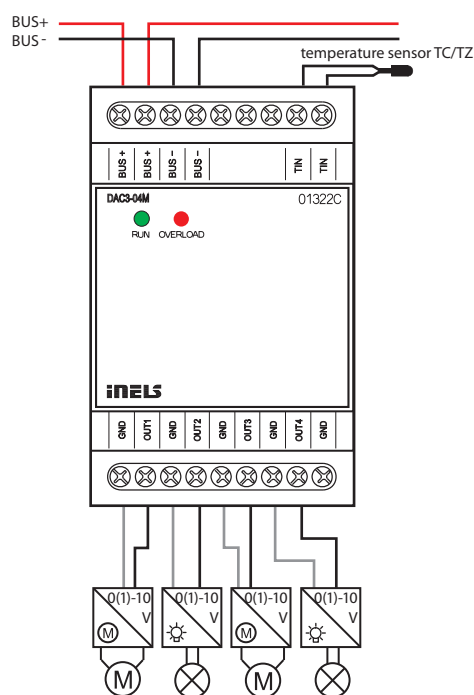



EAN code
DAC3-04B: 8595188132572

Technical parameters DAC3-04B

Inputs

Temperature measuring:	YES, input for external temperature sensor TC/TZ
Range / accuracy of temp. measuring:	-20 to +120°C; 0.5°C from the range

Outputs

Analog voltage output / rated current:	4x 0(1)-10 V/10 mA
--	--------------------

Communication

Installation BUS:	BUS
Status indication unit:	green LED RUN

Power supply

Supply voltage / tolerance:	27 V DC, -20 / +10 %
Dissipated power:	max. 1 W
Rated current:	50 mA (at 27V DC), from BUS

Connection

Terminal:	0.5 - 1 mm ²
-----------	-------------------------

Operating conditions

Operating temperature:	-20 to +55 °C
Storing temperature:	-30 to +70 °C
Protection degree:	IP30
Overvoltage category:	II.
Pollution degree:	2
Operating position:	any
Installation:	into installation box

Dimensions and weight

Dimensions:	49 x 49 x 13 mm
Weight:	27 g

- DAC3-04B is converter of a digital signal to an analog voltage signal.
- The converter generates 4 analog voltage signals, which can be regulated according to type of controlled device, in a range 0-10 V or 1-10 V.
- This is used for regulating and controlling devices that may be controlled by this signal (dimnable ballasts of fluorescent lamps and other types of light sources - e.g. LED panels from the assortment of ELKO Lighting, dimming actuator for LED and RGB strips RFDA-73M/RGB, thermostatic heads, servo drives, elements for measuring and regulation and others).
- Range of output voltage is adjustable in iDM3.
- DAC3-04B is equipped with a temperature input for connecting a 2-wire external sensor TC / TZ.
- DAC3-04B in version B is designed for mounting into an installation box.

Connection

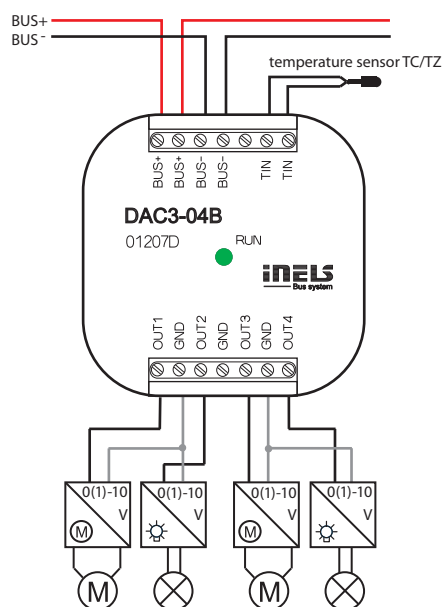

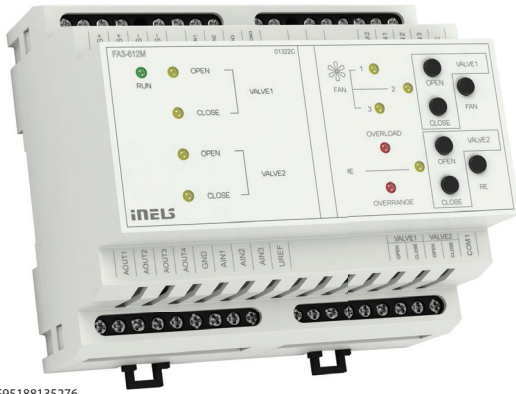

EAN code
FA3-612M: 8595188135276

- FA3-612M is a unit (actuator) designed to control fan coil units using analogue / digital inputs and analog / relay outputs.
- Analog inputs for temperature, voltage or current measurement (Uref reference voltage can also be used).
- Digital inputs of NO / NC type with galvanic isolation and potential (24 - 230 V AC / DC).
- Analog outputs 0-10V.
- Connection to the installation BUS.
- Buttons for closing / opening the valve, fan and heating relay.
- The front panel LEDs indicate the status of each output.
- FA3-066M in 6-MODULE version is designed for mounting into a switchboard, on DIN rail EN60715.

Technical parameters		FA3-612M
Input		
Analog inputs:	3x voltage, current or temperature input	
Number of inputs:	6	
Galv. separation from inner circuits:	No	
Diagnostic:	indication (exceeding the range, interruption of a sensor or overload of Uref output) by the applicable red LED	
Common terminal:	COM	
Converter resolution:	14 bits	
Input resistance		
- for voltage ranges:	approx. 150 kΩ	
- for current ranges:	100 Ω	
Types of inputs / measuring ranges*:	Voltage (U): 0 ÷ +10 V (U) ; 0 ÷ +2 V (U) Current (I): 0 ÷ +20 mA (I) ; ÷ +20 mA (I) temperature: input at ext. temperature sensor TC, TZ, Ni1000, Pt1000, Pt100 see accessories / according to used sensor from -30°C to 250°C	
Digital inputs:	3x switching or expansion, positive logic (SINK)	
Input voltage:	20 - 240 V AC (50 - 60 Hz) / DC	
Galv. separation from internal circuits:	Yes	
Common lead:	GO_COM	
Outputs		
Analog:	4x (A_OUT1 - A_OUT4)	
Voltage analog. output / max. Current:	4x 0(1) - 10 V / 10 mA	
Uref reference voltage outputs		
Voltage / Current Uref:	10 V DC / 100 mA	
Output overload indication:	red LED OVERLOAD	
SSR (Electronic Relay):	4x (VALVE1 - VALVE2)	
Switching voltage:	20 - 240 V AC	
Switching capacity:	480 VA	
Peak current:	20 A, t ≤ 16 ms	
Output indication:	yellow LED	
Relay:	4x (RE1 - RE4)	
Switching voltage:	250 V AC1, 30 V DC	
Switching capacity:	1500 VA/AC1, 180 W/DC	
Relay outputs separated from from all internal circuits:	reinforced Insulation (Cat. II surges by EN 60664-1)	
Minimum switching load:	500 mW (12 V / 10 mA)	
Mechanical life:	10x10 ⁶	
Electrical life AC1:	6x10 ⁴	
Output indication:	yellow LED	

* selectable for each input/output individually by configuration in the user program iDM3.

Communication	
Installation BUS:	BUS
Status indication unit:	green LED RUN
Power supply	
Supply voltage / tolerance:	27 V DC, -20 / +10 %
Rated current:	5 mA (at 27V DC), from BUS
Connection	
Terminal:	max. 2.5 mm ² /1.5 mm ² with sleeve
Operating conditions	
Operating temperature:	-20 to +55 °C
Storing temperature:	-30 to +70 °C
Protection degree:	IP20 device, IP40 mounting in the switchboard
Overvoltage category:	II.
Pollution degree:	2
Operating position:	any
Installation:	switchboard on DIN rail EN 60715
Design:	6-MODULE
Dimensions and weight	
Dimensions:	90 x 105 x 65 mm
Weight:	307 g

Connection

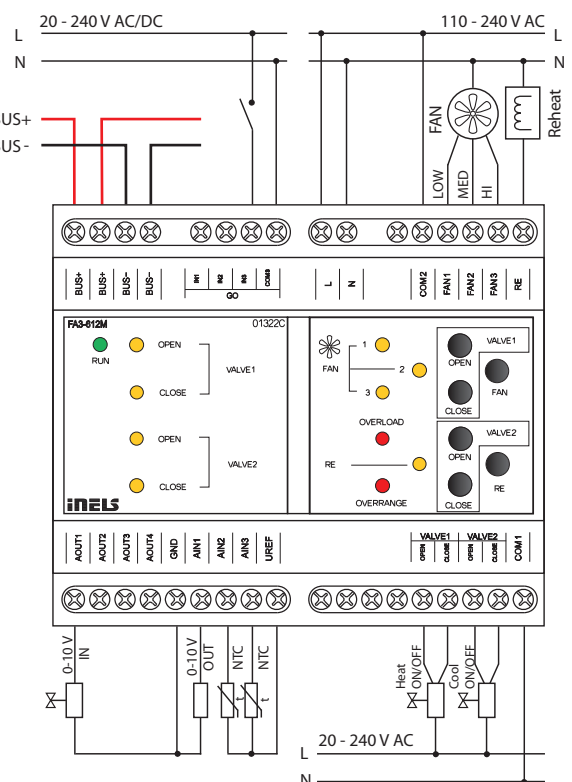



EAN code*

Technical parameters	EST3
Display	
Type:	colored TFT LCD
Aspect ratio:	3:4
Visible area:	52.5 x 70 mm
Backlight:	active
Touchpad:	4-wire resistive
Display:	3.5"
Number of points:	240 x 320
Color Depth:	16.7M (24 bit color)
Power supply	
Supply voltage / tolerance:	27 V DC, -20 / +10 %
Dissipated power:	max. 2 W
Rated current:	150 mA (at 27V DC)
Connection	
Connection:	terminals
Connecting conductors profile:	max. 2.5mm ² /1.5mm ² with sleeve
Operating conditions	
Operating temperature:	0 to +55°C
Storing temperature:	- 20 to +70°C
Protection degree:	IP20
Overvoltage category:	II.
Pollution degree:	2
Operating position:	any
Installation:	installation box
Dimensions and weight	
Dimensions:	94 x 94 x 36 mm
Weight:	120 g

* Ordering codes of all colours are available in the iNELS price list.

** Weight is listed with plastic frame.

- The control unit with touch screen EST3 is a suitable control element of the iNELS system in places where it is necessary to control multiple devices. The unit replaces several drivers and enables minimizing the number of switches on the wall.
- EST3 features a 3.5" color touchscreen with an aspect ratio of 3:4. The basic display resolution is 240 x 320 pixels. The color depth of 16.7 million colors (24 bit color, True Color).
- Use the touch sensing surface to control configured buttons and symbols on the screen just by a light touch of a finger. Individual symbols on the screen are in the "Press" animated by the associated output in the system.
- EST3 has these screens (the displayed screens can be set in iDM3):
 - Buttons screen
 - Temperature control screen
 - Control RGB/RGBY/RGBW light sources screen
- Selecting the default screen is possible from the iDM3 software.
- For screen of buttons one of four different matrixes buttons can be used - 2x2, 2x3, 3x3 and 3x4. Matrix selection can be done from the iDM3 software. On the screen can then be used up to 12 buttons to control appliances or scenes.
- In the menu settings, directly on the EST3 component one of 48 prepared symbols (for control of lighting, shading, scenes and other technologies) can be assigned to each button or the buttons can be used to enter text (number of characters depends on the matrix of buttons and therefore the size of the buttons).
- The temperature regulation screen enables coordination of the temperature of the selected heating circuit in a range of ± 3 , ± 4 or ± 5 °C (in relation to settings in iDM3).
- The virtual wheel can be used for temperature correction, where you can drag your finger across the screen to control the temperature by half a degree Celsius.
- The temperature correction can also be used instead of the virtual wheel symbols "+" and "-".
- EST3 units do not have an integrated temperature sensor, or terminals for connection to an external temperature sensor. Within the iDM3 software, it is possible to assign any unit of heat input system iNELS.
- The control RGB/RGBY/RGBW light sources screen allows you to comfortably control your RGB/RGBY/RGBW light sources and adjust the luminous atmosphere as needed.
- For these RGB/RGBY/RGBW light sources, it is possible to use the controls on the screen to adjust the color and brightness. It is also possible to directly set the RGB/RGBY/RGBW illumination light source into white color.
- Located in the left upper corner of the screen are 4 indicators that can signal the status of any logical input / output in the iNELS system.
- In iDM3 it is possible to define the displayed screen, the default screen, matrix of buttons, type RGB/RGBY/RGBW and a correction range for the temperature control.
- In the settings menu directly on the device EST3 it is possible to select the menu language, screen saver, sleep mode, brightness adjustment and symbols and texts for each button.
- EST3 are designed as LOGUS⁹⁰ devices (EST3 however cannot be placed into multi-frames with other devices in this design) and are intended for mounting to installation box.

Connection

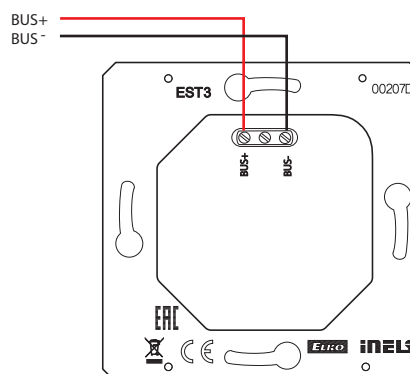

The screenshots

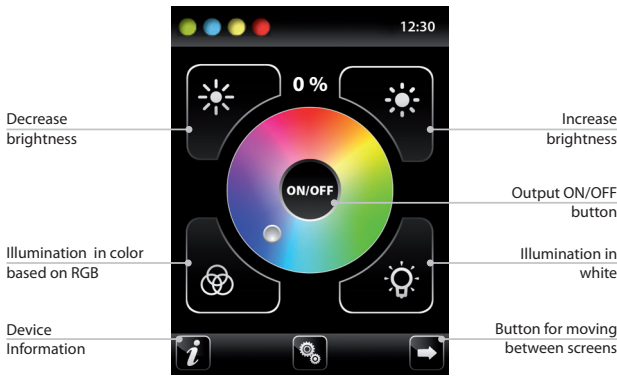

RGB lamp and light source control screen

- The RGB light sources control screen contains controls for managing the desired color and brightness of the RGB light sources.
- RGB control screen function is set up so that the colors R, G, B are bound together and simulate the signal level on analog inputs R, G, B and the resulting brightness of the lamp is linked to a simulated analog input 0 to 100%.
- The RGB control display is comprised of several elements and buttons.
 - A long press (touch) on the ON/OFF controls the central setting of RGB components and lamp brightness - on/off.
 - Buttons in the upper half of the screen are for setting the lamp brightness from 0-100% in 5% increments (see adjustable brightness indicator in %).
 - Buttons in the lower half of the screen are for setting the color comfort and accelerated lamp RGB control. The buttons have a lock function. When pressing "white illumination" button, the analog inputs are automatically set to the maximum value of individual color components, which appears as a resulting white light at the RGB light source output when these components are mixed. Then simply adjust the brightness intensity at the output. When pressing (touching) the button "RGB-based color illumination", the "white illumination", button automatically unlocks, and the "RGB-based color illumination" settings button locks.. Now the values of analog inputs of individual RGB color components are preset according to the set cursor in the color wheel of the RGB scale on the EST3.

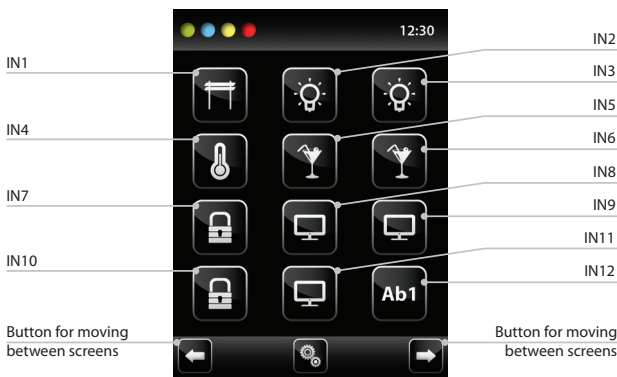

Heating control screen

- On the temperature control screen, the temperature of the selected heating circuit can be corrected in the range of ± 3 , ± 4 or ± 5 °C.
- The virtual wheel can be used for temperature correction, where you can drag your finger across the screen to control the temperature by half a degree Celsius.
- The temperature correction can also be used instead of the virtual wheel symbols "+" and "-" .

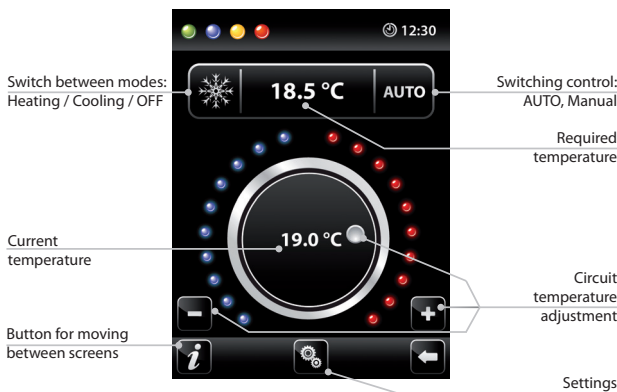

Buttons screen

- Programming iNELS system functions on each button on the screen units EST3 is the same as programming other digital inputs or events for input or button units.
- Buttons can be configured as well as other inputs in the system, both for short and also long press (> 1.5 s).
- Buttons (icons) on the screen can be used instead of control outputs for visualization of one of the digital outputs of the system iNELS. This is made possible by assigning button to the desired output.
- In doing so, the button (icons) on the screen EST3 will become signal lamps (illuminated button), showing the state of the associated output.

Additional information

- Info gives information on the device and firmware version.
- Clicking the icon brings you to the settings menu, used to edit the EST3.
- The icon returns to the buttons panel.
- The system time is displayed in the upper right corner of the screen.
- All inputs and outputs on the EST3 unit can be freely programmed and parameterized using the iDM3 program.

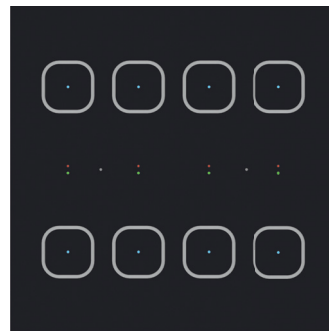
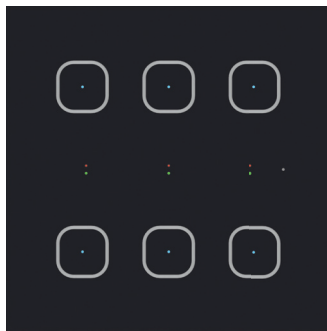
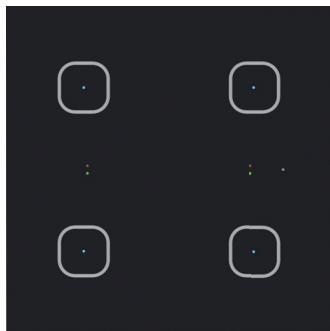

EAN code

GSB3-40/B: 8595188132909

GSB3-60/B: 8595188132916

GSB3-80/B: 8595188132923

Technical parameters	GSB3-40	GSB3-60	GSB3-80
----------------------	---------	---------	---------

Inputs			
Temperature measuring:	YES, built-in thermo sensor		
Scope and accuracy of temp. measuring:	0 to +55°C; 0.3°C from the range		
Number of touch buttons:	4	6	8
Inputs:	2x AIN/DIN		
Resolution:	according to the settings, 10 bits		
Ext. temperature sensor:	Yes, the connection between AIN1/DIN1 and AIN2/DIN2		
Type of ext. sensor:	TC/TZ		
Temperature measurement range:	-20°C to +120°C		
Temperature measurement accuracy:	0.5°C from range		
Outputs			
Indications:	pair of LEDs (red, green)		
Number of LED:	2	3	4
Communication			
Installation BUS:	BUS		
Power supply			
Supply voltage / tolerance:	27 V DC, -20 / +10 %		
Dissipated power:	max. 0.5 W		
Rated current:	25 - 40 mA (at 27V DC), from BUS		
Connection			
Terminals:	0.5 - 1 mm ²		
Operating conditions			
Relative humidity:	max. 80 %		
Operating temperature:	-20 to +55 °C		
Storing temperature:	-30 to +70 °C		
Protection degree:	IP20		
Overvoltage category:	II.		
Pollution degree:	2		
Operation position:	any		
Installation:	into installation box		
Dimensions and weight			
Dimensions:	94 x 94 x 36 mm		
Weight:	155 g		

- The wall controller with touch controls series GSB3 is a design element (controller) in the system iNELS with elegant and comfortable control. Controllers are available in black (e.g. GSB3-40/B) and white (e.g. GSB3-40/W) variants.
- Between each pair of touch buttons there is available a pair of indicator LEDs (green, red) to signal not only the status of the controlled appliances, but also the status of any sensor or actuator in the system.
- At the location of each touch button there is available a blue diode signaling the touching of the given button. Touching may be signaled by a vibration impulse or sound tone - selectable in the software iDM3.
- Controllers are 4-channels (GSB3-40), 6-channels (GSB3-60) and 8-channels (GSB3-80).
- All versions are in the same dimension as a basic modular wall-switch (94x94 mm).
- Each controller is equipped with a thermo sensor. It is equipped with two analog-digital inputs (AIN / DIN), and it is possible to connect two potentialless contact or an external temperature sensor TC / TZ. (for example on floor temperature measurement).
- Controllers are equipped with an ambient light intensity sensor. From the basic information from the sensor, it is possible to illuminate orientation blue diodes in the touch controls GSB3 or perform various actions in the software iDM3, e.g. illuminate light circuits in a hallway, etc.
- Advantages over conventional switches/buttons include space saving, signaling of any output system, the ability to measure temperature and also the ability to connect external buttons or detectors.
- Each channel(button) can control any actuator (appliance) in the system. It is also possible to program various functions or macro (set of functions) to each button. This allows you to control several appliances with one button simultaneously.
- Each button (channel) can have different functional modes beside lighting control:
 - a) Classic wall-switch:
 - upper button ON, bottom button OFF.
 - b) Button controller (impulse relay):
 - first press ON, second press OFF.
 - c) Dimmer:
 - short press – ON/OFF.
 - d) Time switch:
 - ON after press, automatically OFF after set time.
 - e) Setting light scenes – for example: for watching TV:
 - shutters down
 - main light 30% intensity
 - wall-lamps 50% intensity.
- Design series LOGUS⁹⁰ offers glass frames in black and white color. These frames goes perfectly with GSB3 wall buttons.

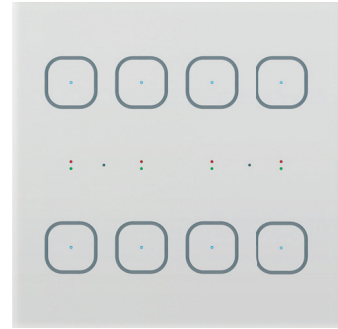
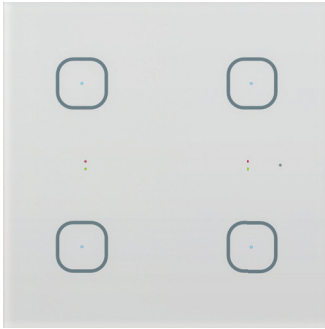

EAN code

GSB3-40/W: 8595188132954
 GSB3-60/W: 8595188132985
 GSB3-80/W: 8595188132992

Connection

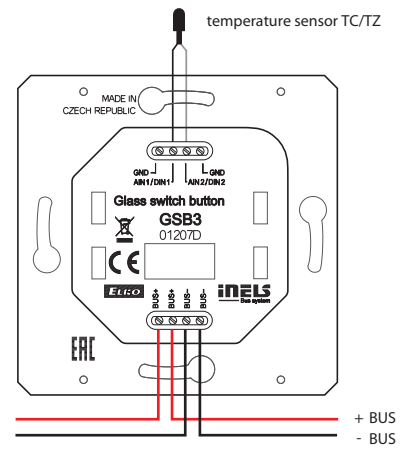
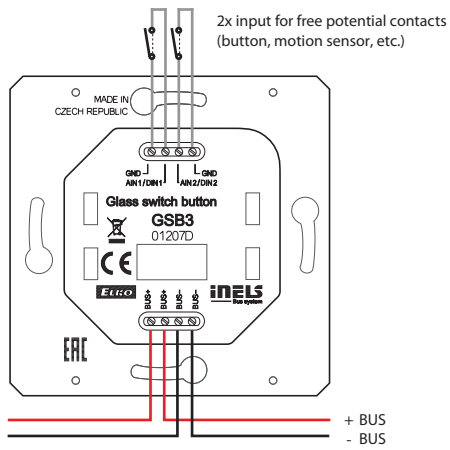

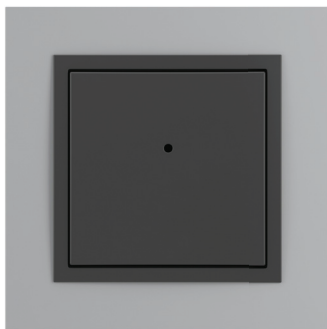

EAN code
WSB3-20: 8595188132343
WSB3-20H: 8595188132473

Technical parameters	WSB3-20	WSB3-20H
Inputs		
Temperature measuring:	YES, built-in temperature sensor	
Scope and accuracy of temp. measuring:	0 to +55°C ; 0.3°C from the range	
Number of control buttons:	2	
Humidity measurement:	NO	YES
Humidity measurement range:	-	0 to 99% Relative humidity
Humidity measurement accuracy:	-	± 3 % Relative humidity
Inputs:	2x AIN/DIN	
External temperature sensor:	YES, the connection between AIN1/DIN1 and AIN2/DIN2	
Type of ext. sensor:	TC/TZ	
Temperature measurement range:	-20 °C to +120 °C	
Temp. measurement accuracy:	0.5 °C from range	
Outputs		
Indication:	two-colored LED (red, green)	
Number of LEDs:	1	
Communication		
Installation BUS:	BUS	
Power supply		
Supply voltage / tolerance:	27 V DC, -20 / +10 %	
Dissipated power:	max. 0.5 W	
Rated current:	25 mA (at 27V DC), from BUS	
Connection		
Terminals:	0.5 - 1 mm ²	
Operating conditions		
Operating temperature:	-20 .. +55 °C	
Storing temperature:	-30 .. +70 °C	
Protection degree:	IP20	
Overvoltage category:	II.	
Pollution degree:	2	
Operation position:	any	
Installation:	into installation box	
Dimensions and weight		
Dimensions		
- plastic:	85.6 x 85.6 x 42 mm	
- metal, glass, wood, granite:	94 x 94 x 36 mm	
Weight:	55 g (without frame)	

- Wall controllers with low-upstroke control WSB3-20 and WSB3-20H are the main and most frequently used units (controller) in the iNELS system.
- Built-in micro-buttons with low upstroke offer elegant and easy control.
- Wall switches WSB3-20 and WSB3-20H are available in two-channel version.
- Double color (red/green) LED diode indicates either status of controlled appliances or status of any sensor or actuator in the system.
- Wall buttons in WSB3 series are compatible with both types of frames LOGUS⁹⁰ (85.6 x 85.6 or 94 x 94 mm), therefore you can combine them with double and triple frames and classic products of the series.
- Each controller is equipped with a temperature sensor. It is also equipped with two analog/digital inputs (AIN/DIN), which can be used to connect two potentialless contacts or one external temperature sensor TC/TZ (e.g. for measuring floor temperature).
- Wall button WSB3-20H is comparable to the WSB3-20 but additionally equipped with a relative humidity meter, and for better access of air to the sensor can be used with 99621T including accessories 99622 (Vista MT) and 99,623 (Vista IRMT), instead of the housing cover 99601T.
- Compared to standard wall buttons WSB3-20 and WSB3-20H are more flexible and multifunctional. You can for example controll appliances by short and long push of the button (e.g.: dimming, shutter control, scenes).
- Each button can control any appliance in the system and can use a variety of centralized or time controlled features. Accordingly, the customer can choose the simplicity / complexity of the operation. The big advantage is the possibility to change the method of control by only making software modifications without physical interventions into the structure of the building.
- Each button (fold) can have different functional modes beside lighting control:
 - a) Classic wall-switch:
 - upper button ON, bottom button OFF.
 - b) Button controller (impulse relay):
 - first press ON, second press OFF.
 - c) Dimmer:
 - short press – ON/OFF.
 - d) Time switch:
 - ON after press, automatically OFF after set time.
 - e) Setting light scenes – for example: for watching TV:
 - shutters down
 - main light 30% intensity
 - wall-lamps 50% intensity.
- WSB3 in LOGUS⁹⁰ design is designed for mounting into an installation box.

Connection

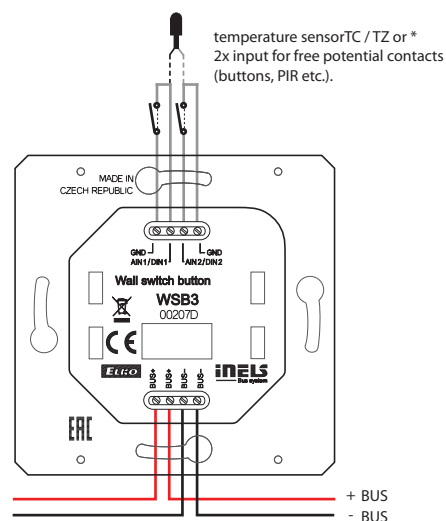

* The choice is made in iDM3 for each unit separately.

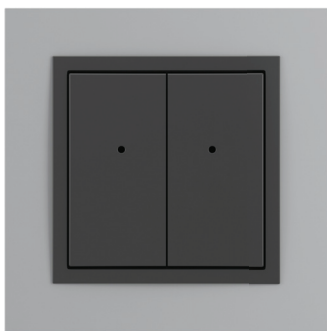

EAN code
 WSB3-40: 8595188132336
 WSB3-40H: 8595188133043

Technical parameters	WSB3-40	WSB3-40H
Inputs		
Temperature measuring:	YES, built-in temperature sensor	
Scope and accuracy of temp. measuring:	0 to +55°C ; 0.3°C from the range	
Number of control buttons:	4	
Humidity measurement:	NO	YES
Humidity measurement range:	-	0 to 99% Relative humidity
Humidity measurement accuracy:	-	± 3 % Relative humidity
Inputs:	2x AIN/DIN	
External temperature sensor:	YES, the connection between AIN1/DIN1 and AIN2/DIN2	
Type of external sensor:	TC/TZ	
Temp. measurement range:	-20 °C to +120 °C	
Temp. measurement accuracy:	0.5 °C from range	
Outputs		
Indication:	two-colored LED (red, green)	
Number of LEDs:	2	
Communication		
Installation BUS:	BUS	
Power supply		
Supply voltage / tolerance:	27 V DC, -20 / +10 %	
Dissipated power:	max. 0.5 W	
Rated current:	25 mA (at 27V DC), from BUS	
Connection		
Terminals:	0.5 - 1 mm ²	
Operating conditions		
Operating temperature:	-20 .. +55 °C	
Storing temperature:	-30 .. +70 °C	
Protection degree:	IP20	
Overvoltage category:	II.	
Pollution degree:	2	
Operation position:	any	
Installation:	into installation box	
Dimensions and weight		
Dimensions		
- plastic:	85.6 x 85.6 x 42 mm	
- metal, glass, wood, granite:	94 x 94 x 36 mm	
Weight:	55 g (without frame)	

- Wall mounted controllers with upstroke control WSB3-40 and WSB3-40H are the basic and most popular feature (control) of the iNELS system.
- Built-in micro-switch with low upstroke offers elegant and pleasant control.
- Controllers WSB3-40 and WSB3-40H are supplied with four channels.
- Two-coloured indication LEDs located in each controller, can signal the status of controlled appliances or the status of any sensor or actuator in the system.
- Wall buttons in WSB3 series are compatible with both types of frames LOGUS⁹⁰ (85.6 x 85.6 or 94 x 94 mm), therefore you can combine them with double and triple frames and classic products of the series.
- Each controller is equipped with a temperature sensor. It is also equipped with two analog/ digital inputs (AIN/DIN), which can be used to connect two potentialless contacts or one external temperature sensor TC/TZ (e.g. for measuring floor temperature).
- Compared to standard wall buttons WSB3-20 and WSB3-20H are more flexible and multifunctional. You can for example controll appliances by short and long push of the button (e.g.: dimming, shutter control, scenes).
- Each button can control any appliance in the system and can use a variety of centralized or time controlled features. Accordingly, the customer can choose the simplicity / complexity of the operation. The big advantage is the possibility to change the method of control by only making software modifications without physical interventions into the structure of the building.
- Each button (fold) can have different functional modes beside lighting control:
 - a) Classic wall-switch:
 - upper button ON, bottom button OFF.
 - b) Button controller (impulse relay):
 - first press ON, second press OFF.
 - c) Dimmer:
 - short press – ON/OFF.
 - d) Time switch:
 - ON after press, automatically OFF after set time.
 - e) Setting light scenes – for example: for watching TV:
 - shutters down
 - main light 30% intensity
 - wall-lamps 50% intensity.
- WSB3 in LOGUS⁹⁰ design is designed for mounting into an installation box.

Connection

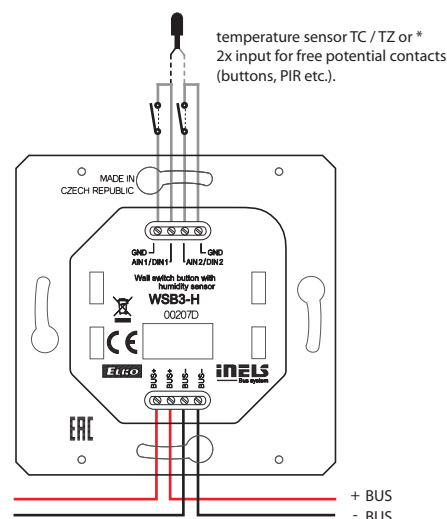

*The choice is made in iDM3 for each unit separately.

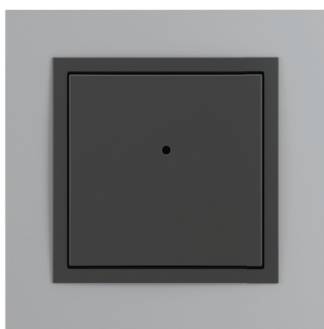

EAN code
WMR3-21: 8595188132756

Technical parameters		WMR3-21
Inputs		
Number of control buttons:		2
RFID readers		
Supported frequencies:		13.56 MHz
Card Type:		MIFARE Ultralight, DESFire 2K (EV1), DESFire 4K (EV1)
Outputs		
Output:		1x changeover 8A / AgSnO ₂
Indication:		two-color LED (red, green)
Acoustic output:		piezo-changer
Switching voltage:		230V AC/ 30V DC
Switching output:		2000 VA/AC1; 240 W/DC
Peak current:		20 A/<3s
Insulation voltage between relay outputs and internal circuits:		3.75 kV, SELV according to EN 60950
Minimal switched current:		10 mA / 10 V
Switching frequency without load:		300 min ⁻¹
Switching frequency with rated load:		15 min ⁻¹
Mechanical life:		1x 10 ⁷
Electrical life AC1:		1x 10 ⁵
Communication		
Installation BUS:		BUS
Power supply		
Supply voltage / tolerance:		27 V DC, -20 / +10 %
Dissipated power:		max. 0.5 W
Rated current:		50 mA (at 27V DC), from BUS
Connection		
Data:		terminals, 0.5 - 1 mm ²
Network:		max. 2.5 mm ² /1.5 mm ² with sleeve
Operating conditions		
Operating temperature:		-20 to +55 °C
Storing temperature:		-30 to +70 °C
Protection degree:		IP20
Overvoltage category:		II.
Pollution degree:		2
Operation position:		any
Installation:		into installation box
Dimensions and weight		
Dimensions		
- plastic:		85.6 x 85.6 x 42 mm
- metal, glass, wood, granite:		94 x 94 x 36 mm
Weight:		68 g (without frame)

- WMR3-21 is a wall-mounted card reader that is designed to read contactless media (smart cards, key chains, etc.), which are used for controlling access to buildings or their parts.
- With the glass controller WMR3-21 users will appreciate the easy of control using two push buttons, which can be assigned different control functions lighting, shading, scenes, heating, etc.
- WMR3-21 reader can be used to control the security system (locking / unlocking) access system (opening doors, gates, etc.) or appliances (based on assigned rights).
- WMR3-21 supports RFID media with the carrier frequency of 13.56 MHz. Supported card types MIFARE Ultralight, DESFire 2K (EV1), DESFire 4K (EV1).
- WMR3-21 is also equipped with 8A relay output with changeover contact AgSnO₂, by which controlled devices can be switched directly (or any actuator in the system can be set in software iDM3).
- Indication two-color LED in the controller cover can indicate not only the status of controlled appliance, but also the status of any sensor or actuator in the system.
- Wall card reader WMR3-21 is compatible with both types of frames LOGUS⁹⁰ (85.6 x 85.6 or 94 x 94 mm), therefore you can combine them with double and triple frames and classic products of the series.

Connection

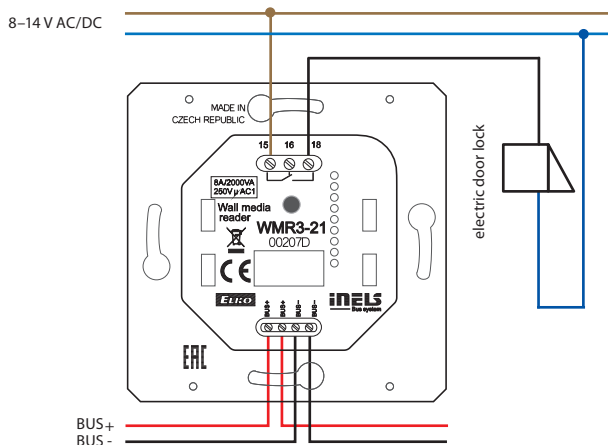

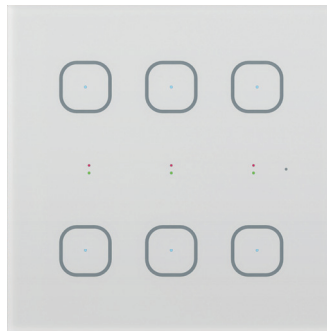
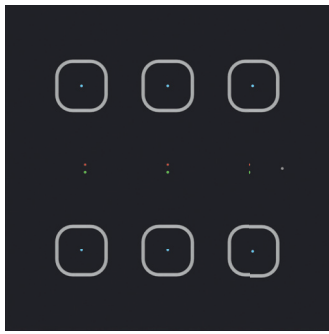

EAN code
GMR3-61/B: 8595188155854
GMR3-61/W: 8595188155793

Technical parameters		GMR3-61
Inputs		
Temperature measuring:	YES, built-in temperature sensor	
Scope and accuracy of temp. measuring:	0 to +55°C; 0.3°C from the range	
Number of control buttons:	6	
RFID readers		
Supported frequencies:	13.56 MHz	
Card Type:	MIFARE Ultralight, DESFire 2K (EV1), DESFire 4K (EV1)	
Outputs		
Indication:	3 pairs of LED (red, green)	
Output:	1x changeover 8A / AgSnO ₂	
Acoustic output:	piezo-changer	
Switching voltage:	230V AC/ 30V DC	
Switching output:	2000 VA/AC1; 240 W/DC	
Peak current:	20 A/<3s	
Insulation voltage between relay outputs and internal circuits:	3.75 kV, SELV according to EN 60950	
Minimal switched current:	10 mA / 10 V	
Switching frequency without load:	300 min ⁻¹	
Switching frequency with rated load:	15 min ⁻¹	
Mechanical life:	1x 10 ⁷	
Electrical life AC1:	1x 10 ⁵	
Communication		
Installation BUS:	BUS	
Power supply		
Supply voltage / tolerance:	27 V DC, -20 / +10 %	
Dissipated power:	max. 2 W	
Rated current:	50 mA (at 27V DC), from BUS	
Connection		
Data:	terminals, 0.5 - 1 mm ²	
Network:	max. 2.5 mm ² /1.5 mm ² with sleeve	
Operating conditions		
Relative humidity:	max. 80 %	
Operating temperature:	-20 to +55 °C	
Storing temperature:	-30 to +70 °C	
Protection degree:	IP20	
Overvoltage category:	II.	
Pollution degree:	2	
Operation position:	any	
Installation:	into installation box	
Dimensions and weight		
Dimensions:	94 x 94 x 36 mm	
Weight:	155 g	

- Wall RFID card reader GMR3-61 is designed for reading of contactless media (chip cards, key fobs, tags, etc.), which are used for controlling access to buildings or parts of buildings.
- With the glass controller GMR3-61 users will appreciate the elegant design and the easy of control using six touch buttons, which can be assigned different control functions lighting, shading, scenes, heating, etc.
- GMR3-61 a design element of the (control) system iNELS and is available in black (GMR3-61/B) and white (GMR3-61/W) variants.
- GMR3-61 reader can be used to control the security system (locking / unlocking) access system (opening doors, gates, etc.) or appliances (based on assigned rights).
- GMR3-61 supports RFID media with the carrier frequency of 13.56 MHz. Supported card types MIFARE Ultralight, DESFire 2K (EV1), DESFire 4K (EV1) .
- The GMR3-61 is also equipped with 8A relay output with changeover contact AgSnO₂, which can be switched directly by reader (or by any controller in the system).
- Between each pair of touch keys is a pair of indicator LEDs (Green, Red) to indicate the status of the controlled appliance, or the state of any sensor or actuator in the system.
- Located on each touch button is a blue LED indicator, signalling the touch of a button. Touching may also be signalled by a vibrating pulse or audible tone - optionally in the software iDM3.
- All variants of GMR3-61 are available in sizes of luxury controllers LOGUS⁹⁰ (94 x 94 mm).
- GMR3-61 reader is equipped with a sensor of ambient light intensity. Based on information from the sensor can switch the orientation of blue LEDs on the touch-pad GSB3 or perform various actions with the software iDM3, eg. To control the lighting circuits in the corridor and others.
- GMR3-61 cannot be installed into multiple frames they are designed for mounting into installation boxes.

Connection

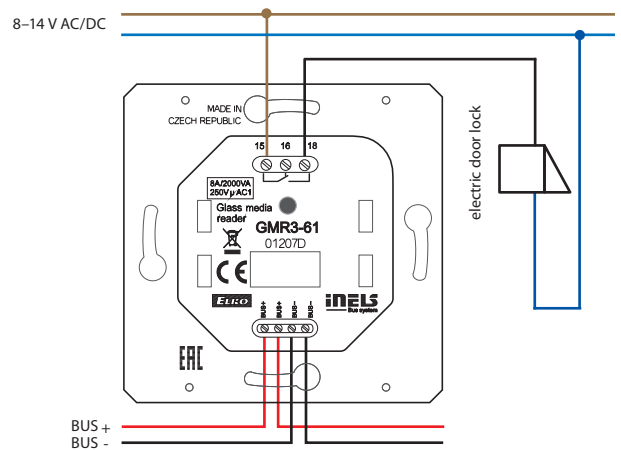



EAN code

IDRT3-1 white:	8595188149488 (device, cover)
IDRT3-1 ivory:	8595188179614 (device, cover)
IDRT3-1 ice:	8595188179591 (device, cover)
IDRT3-1 pearl:	8595188179621 (device, cover)
IDRT3-1 aluminium:	8595188179584 (device, cover)
IDRT3-1 gray:	8595188179607 (device, cover)

Technical parameters IDRT3-1

Inputs	
Temperature measuring:	YES, built-in thermo sensor
Range / accuracy of temp. measuring:	0 to +55°C; 0.3°C from range
Heating/cooling circuit correction:	±3, ±4 or ± 5 °C
Manual control of heating/cooling circuit:	2 x buttons
External temperature sensor:	YES, the connection between AIN1/DIN1 and AIN2/DIN2
Type of external sensor:	TC/TZ
Temperature measurement range:	-20°C to +120°C
Temperature measurement accuracy:	0.5°C from range
Communication	
Installation:	BUS
Display:	symbol display
Backlight:	YES
Power supply	
Supply voltage / tolerance:	27 V DC, -20 / +10 %
Dissipated power:	max. 0.5 W
Rated current:	20 mA (at 27V DC), from BUS
Connection	
Terminals:	0.5 - 1 mm ²
Operating conditions	
Operating temperature:	0 to +50 °C
Protection degree:	IP20
Overvoltage category:	II.
Pollution degree:	2
Operation position:	vertical, downward with BUS terminal
Installation:	into installation box
Dimensions and weight	
Dimensions	
- plastic:	85.6 x 85.6 x 50 mm
- metal, glass, wood, granite:	94 x 94 x 50 mm
Weight:	76 g (without frame)

- IDRT3-1 is a digital wall temperature controller used to regulate the temperature in a room.
- Using the IDRT3-1, it is possible to correct the given heating/cooling circuit within a range of ±3, ±4 or ±5 °C (optional in SW iDM3).
- The temperature controller is equipped with an integrated heat sensor used to measure the room temperature. It is also equipped with two analog digital inputs (AIN/DIN), which can be used to connect two potential free contacts or a single external temperature sensor TC/TZ (e.g. for measuring the floor temperature).
- The display shows the current temperature and after pressing one of two buttons under the display, you can control the desired temperature.
- Readability improves after pressing one of the buttons to activate the backlight.
- Heating/cooling circuit is assigned with a thermo-regulator using iDM3.
- In the case of temperature correction within ±3, ±4 or ± 5 °C, this change is valid until the next time mark within the time schedule established in iDM3.
- IDRT3 -1 in design LOGUS⁹⁰ is intended for mounting into an installation box.

Connection

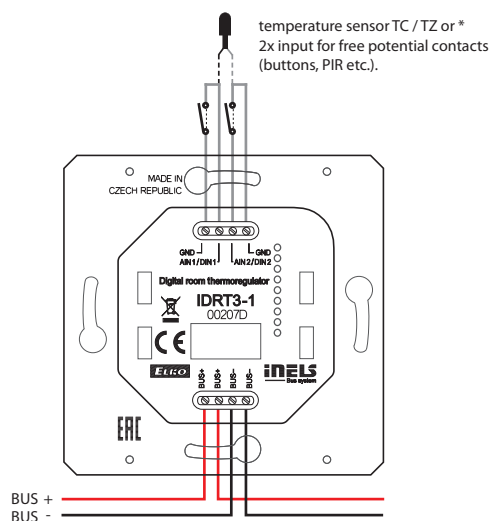

* The choice is made in iDM3 for each unit separately.

Lighting control

Smart home & building solutions



www.inels.com

INELS[®]



EAN code
EMDC-64M: 8595188150309

Technical parameters EMDC-64M

Power supply

Supply voltage / tolerance /	AC 230 V (50 - 60 Hz) /
Rated current:	-15 / +10 % / max. 100 mA
DALI power supply:	16 V, 250 mA
Dissipated power:	max. 3 W

Communication

Input interface:	EBM BUS (RS485 communication)
Output interface:	DALI (max. 64 ballasts) DMX (max. 32 receivers, with repeater to 64)

Indication

Power supply:	green LED Un
Error surge or short DALI:	illuminated red LED ERR
Indication of unit status:	LED DALI/DMX (see iNELS installation handbook)

Operating conditions

Relative humidity:	max. 80 %
Operating temperature:	-20°C to +55°C
Storage temperature:	-30°C to +70°C
Protection degree:	IP20 device, IP40 mounitg in the switchboard
Control device purpose:	operating control device
Control device construction:	individual control device
Characteristic of automatic action:	2.5 kV
Overvoltage category:	II.
Pollution degree:	2
Operating position:	vertical
Installation:	into switchboard on DIN rail EN60715
Implementation:	3-MODULE

Dimension and weight

Dimension:	90 x 52 x 65 mm
Weight:	140g

- The unit EMDC-64M is designed to control DALI electronic ballasts and DMX receivers from the iNELS system.
- EMDC-64M enables control of up to 64 independent electronic ballasts DALI (Digital Addressable Lighting Interface) for fluorescent lamps, LEDs and other light sources.
- EMDC-64M also enables connection of up to 32 receivers DMX (Digital MultipleX) in a single segment. When used repeaters can control up to 64 devices. Maximum amount of DMX controlled channels is 64 channels.
- Control from iNELS BUS System via EBM BUS.
- DIP switches on the front panel to select the control interface (DALI/DMX).
- Addressing of DALI ballast units can be done via the central unit and iDM3 software or via MINI USB on the front panel of the EMDC-64M and DALI Configurator software.
- The required functionality is set in user project in iDM3 software.
- The unit EMDC-64M is powered from the mains voltage 230 V AC.
- DALI BUS power supply is 16V/250 mA via an EMDC-64M unit.
- The system BUS EBM is galvanically separated from the BUSes DALI/DMX. Terminals for connecting the DALI BUS are equipped with short circuit and surge protection.
- It is possible to connect up to 8 EMDC-64M units to one EBM BUS.
- If this concerns the last unit on a system BUS EBM, it is necessary to terminate the wire with a resistor with nominal resistance of 120 Ω. The resistor is inside the unit, termination is made by shorting neighboring terminals TERM and EBM+.
- The BUS DMX must be terminated at its end by a resistor with nominal resistive value 120 Ω. The resistor for DMX BUS termination is on the side of the EMDC-64M inside the unit, termination is performed by shorting adjacent terminals TERM and A.
- Updating the firmware of the EMDC-64M can be done through the central unit and software iDM3 or via MINI USB on the front panel and EMDC-64M Flasher software. Updating through MINI USB must be done while system BUS EBM is disconnected.
- When configuring DALI addresses two types are necessary to distinguished:
 - MASTER - this group includes sensors and detectors and one DALI branch can connect up to 4 DALI MASTER units
 - lighting intensity sensor DLS3-1
 - motion detector DMD3-1
 - SLAVE - electronic lighting ballast
- EMDC-64M in 3-MODULE design is designed for mounting in a control panel on a DIN rail EN60715.

Connection

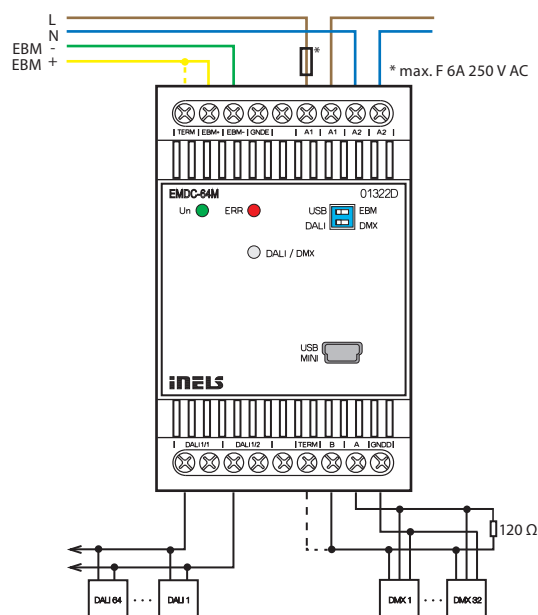



EAN code
DMD3-1: 8595188157513

Technical parameters		DMD3-1
Inputs		
Angle of motion detection:		140°, 4 m
Recommended installation height:		2.5 - 3 m
Changing the PIR sensitivity:		Yes, 0.. 127 (max. sensitivity)
PIR scan type:		single / dual
Default setup PIR:		99 dual
Temperature measuring:		YES, built-in temperature sensor /
Scope and accuracy of temp. measurement:		-25.. +110 °C; ± 0.3 °C
Humidity measurement:		YES
Humidity meas. range:		0 .. 99% RH
Humidity meas. accuracy:		± 4 % RH
Light Metering:		YES
Detection angle:		± 55 °
Measuring range:		1 - 100 000 lx
Number of control buttons:		1
Outputs		
Indication red LED:		identification DALI MASTER / communication options
Indicating blue LED:		PIR Activation
Indication green LED RUN:		communications / unit status
Communication		
Interface:		Installation BUS iNELS DALI
Power supply		
From iNELS BUS:		27 V DC, -20 / +10 %
Rated current:		18 mA
From DALI BUS:		16 V (max. 23 V)
Rated current:		27 mA
Dissipated power:		max. 0.5 W
Connection		
Terminals:		0.3 - 0.8 mm ²
Operating conditions		
Operating temperature:		-20 .. +55 °C
Storing temperature:		-30 .. +70 °C
Protection degree:		IP20
Operation position:		vertical
Installation:		ceiling
Dimension and weight		
Dimension:		Ø 76 x 73 mm
- installation hole diameter:		60 mm
- diameter visible:		76 mm
Weight:		81 g

For proper function of the detector it is necessary to eliminate all interference from heat or light sources in the sensing area.

The detector cannot be installed on an unstable or vibrating surface.

Lower mounting height will reduce the overall size of the detection zone.

The distance from the unit and the colour of the illuminated area affects the resulting value of the measured illumination by the DMD3-1 unit.

- DMD3-1 is a combined detector for ceiling mounting.
- Possibilities to use the DMD3-1:
 - Motion detector
 - Sensor luminescence
 - Temperature measuring
 - Humidity measurement
- The unit is equipped with two communication interfaces:
 - Installation iNELS BUS
 - DALI
- The motion detector is used to detect people moving in the area. Using the passive scanning infrared spectrum for detection.
- Integrated luminescence sensor can be used for sensing current luminescence at the point of installation of the unit. This information can be used in tasks to maintain a constant luminescence. In space where it is possible, thanks to the contribution of natural light from the outside to adjust the artificial light, which can reduce energy consumption.
- Setting the communication interface is done using the SET button.
- The unit can be configured via the iNELS3 Designer & Manager software, which, among other things it is possible to:
 - Set the desired function depending on detected motion.
 - Resolve jobs based on the value of luminescence.
 - Enable / disable the alarm LED on the detector housing.
- DMD3-1 detector is designed for indoor installation and is not intended for outdoor use.
- DMD3-1 detector is powered directly via the iNELS BUS installation (nominal 27 V DC) or DALI BUS (nominal 16 V DC).

Connection

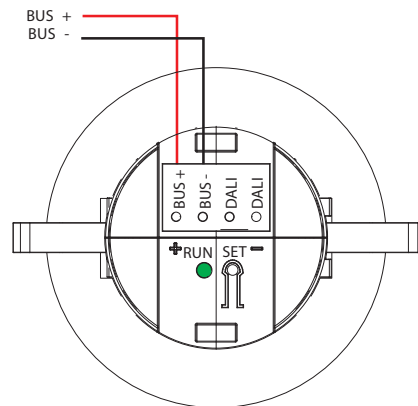

Scanning range

Motion detector

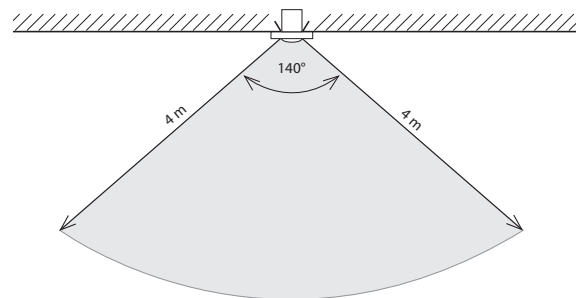

Light sensor

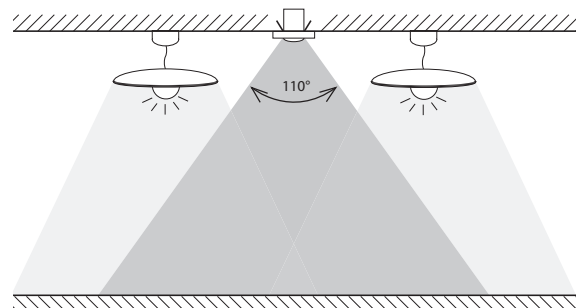



EAN code
DLS3-1: 8595188157506

Technical parameters DLS3-1

Inputs

Range of measurement of lighting:	1 - 100 000 lx
Detection angle:	40 °

Outputs

Indication red LED:	identification DALI MASTER / setting indication
Indication green LED RUN:	communications / unit status

Communication

Interface:	Installation BUS iNELS DALI
------------	--------------------------------

Power supply

From iNELS BUS:	27 V DC, -20 / +10 %
Rated current:	12 mA (27V DC)
From DALI BUS:	16 V (max. 23 V)
Rated current:	20 mA (16 V DC)
Dissipated power:	max. 0.5 W

Connection

Terminals:	max. 1x2.5, max. 2x1.5 / with sleeve max. 1x2.5 mm ²
------------	---

Operating conditions

Operating temperature:	-30 .. +60 °C
Storing temperature:	-30 .. +70 °C
Protection degree:	IP 65
Operating position:	vertical

Dimension and weight

Dimension:	96 x 62 x 34 mm
Weight:	100 g

For proper function of the detector it is necessary to eliminate all sources of light interference in the sensing area.

- The luminescence sensor DLS3-1 is for sensing the current luminescence at the point of installation of the unit.
- The DLS3-1 sensor is equipped with two communication interfaces:
 - iNELS BUS Installation.
 - DALI.
- Information about the current value of the light intensity can be used in tasks of maintaining constant luminescence. In space where it is possible, thanks to the contribution of natural light from the outside to adjust the artificial light, which can reduce energy consumption.
- Thanks to the DLS3-1 units cannot only be used in residential projects, but also in commercial projects, offices or manufacturing plants, warehouses.
- The DLS3-1 unit is recommended to be installed so that the luminescence sensor for sensing faces down and should not be exposed to direct radiation.
- Setting up a communication interface with DIP switches no. 1:
 - In the upper position determines the communication interface DALI
 - In the lower position determines the communication interface iNELS
- The DLS3-1 detector is powered directly via the iNELS BUS installation (nominal 27 V DC) or DALI BUS (nominal 16 V DC).
- The unit can be configured via iNELS3 Designer & Manager software, which, amongst other things it is possible to:
 - Set the desired functions according to the detected illumination.
 - The sensing range is 1-100 000 lux.
 - The DLS3-1 unit is supplied in IP65 and so can be installed in the outdoor environment.

Connection

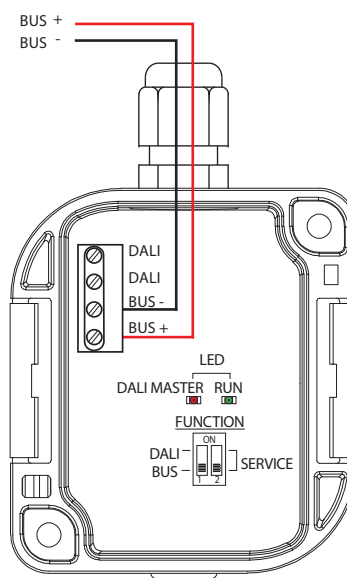

Hospitality Solution

Guest Room Management System



www.inels.com

INELS[®]



EAN code
CU3-04M: 8595188133067

Technical parameters		CU3-04M
LED Indication		
Green LED RUN:	unit operating status indication	
Red LED ERR:	unit error indication	
TFT display		
displays the current status and settings		
Type:	color TFT	
Resolution:	240x240 / 1:1 aspect ratio	
Visible area:	26x26 mm	
Controlling:	using arrows	
The internal real-time clock:	accuracy: 1s/day at 23 °C	
Inputs		
Inputs:	8x DIN GS 12-230V AC/DC (contra to the common terminal COM)	
	4x DIN current or voltage (with adjustable switching of the current mode)	
	7x AIN / DIN current or voltage (with adjustable switching of the current mode)	
Outputs		
Output:	4x AOUT 0(1)-10V max. 10mA / channel 1x RefOUT 5(10)V max. 100mA	
Number of Units connected directly to CU3-04M:	max. 32	
Possibility of expansion via external master:	up to 544 units, 8x Ethernet master	
Output relays separated from all internal circuits:	reinforced Insulation *	
Insulation between COM potentials:	reinforced Insulation *	
Isolates. voltage open relay contact:	1 kV	
SSR (Electronic Relay):	4x NO (OUT3 - OUT6)	
Switched voltage:	20 - 240 V AC	
Switched output:	480 VA	
Peak current:	20 A, t ≤ 16 ms	
Relay 6A:	12x NO (RE1 - RE6, RE11 - RE16), 1x HW block changeover (OUT1 - OUT2)	
Switched voltage:	250 V AC1, 30 V DC	
Switched output:	1500 VA/AC1, 180 W/DC	
Minimum switching load:	500 mW (12 V / 10 mA)	
Mechanical life:	10x10 ⁶	
Electrical life AC1:	6x10 ⁴	
Relay 10A:	4x NO (RE7 - RE10)	
Switched voltage:	250 V AC1, 24 V DC	
Switched output:	2500 VA/AC1, 240 W/DC	
Peak current:	30 A max. 4 s. at 10% duty cycle	
Minimum switching current:	100 mA	
Switching frequency without load:	1200 min ⁻¹	
Switching frequency with rated load:	6 min ⁻¹	
Mechanical life:	3x 10 ⁷	
Electrical life AC1:	0.7x 10 ⁵	

Communication

BUS	
Maximum number of units:	max. 32 units
Maximum cable length:	max. 500 m (depends on power loss)
3x Ethernet	
Connectors:	RJ45 on the underside of the component
Communication speed:	100Mbps
Indication of the Ethernet:	3x green - Ethernet communication 3x yellow - Ethernet speed 100 Mbps
The default IP address (ETH3):	192.168.1.1 (the IP address can be changed in the menu using the display and buttons)
DALI master:	max. 64 master units, max. 64 slaves ***
Internal power supply:	BUS power supply
Max. Internal power supply voltage:	max. 64 mA (option to connect an external power supply)
Power supply	
Supply voltage / tolerance:	27 V DC, -20 / +10 %
Rated current:	110 mA (at 27 V DC)
Operating conditions	
Working temperature:	-20 to +55 °C
Storage temperature:	-25 to +70 °C
Humidity:	max. 80%
Degree of protection:	IP20 devices, IP40 with cover in the switchboard
Overvoltage category:	II.
Degree of pollution:	2
Operating position:	any
Installation:	to the switching board on the EN60715 DIN rail
Design:	2x 6-MODULE
Terminal:	max. 2.5 mm ²
Dimensions and weight	
Dimensions:	90 x 210 x 65 mm (2x (90 x 105 x 65 mm))
Weights:	457 g

iNELS RF Control interface for CU3-04M

Communication protocol:	RF Touch Compatible
Transmitting frequency:	866 MHz / 868 MHz / 916 MHz
Signal transmission methods:	bidirectionally addressed message
Output for RF antenna:	SMA connector**
RF antenna:	1 dB (part of package)
Free space range:	up to 100 m

DIN = digital input
AOUT = analogue output
AIN = analogue input
GS = galvanically isolated

* (Cat. II surges by EN 60664-1)

** Max Tightening Torque for antenna connector is 0.56 Nm.

*** With an external DALI power supply

- CU3-04M control unit is designed to control hotel rooms.
- CU3-04M control unit is designed to enable management of all technology that may be in guest rooms, it is designed to provide maximum comfort while running with maximum efficiency throughout the building.
- CU3-04M is equipped with:
 - Digital input for connecting push-button controls, motion detectors or, for example magnetic detectors.
 - Analog inputs for connecting temperature sensors.
 - Digital outputs for the control of actuators, ventilator fan coil units, door locks, lighting, shading techniques, sockets and other equipment.
 - Analog output 0(1) -10V for controlling actuators and controlled continuously dimmable ballasts, controlled using voltage signals.
 - Installation BUS for connecting up to 32 BUS controllers and thermostats.
 - One DALI BUS for up to 64 electronic ballasts illumination (internal source CU3-04M is able to power the connected ballasts up to a nominal value of 64 mA).
 - RF communication interface for controlling iNELS RF Control wireless receivers (updated list of supported receiver is available in the iNELS installation manual).
- To create a logic of local control configuration software iNELS3 Designer & Manager (iDM3).
- CU3-04M control units can be connected in a complex control system (BMS) 4 Niagara, Niagara AX and Promotic.
- CU3-04M control unit is also able to communicate with a hotel system (PMS) Fidelio, so it is possible, for example, automatically during check-in to run in the room a welcoming scene, immediately signalling requirements for room cleaning etc.
- Thanks to its connection to BMS, it is possible amongst other things to:
 - Monitor the status of all system components from one location.
 - Interconnect iNELS with other protocols.
 - Create logical functions between the managing units.
 - Optimize the performance of HVAC systems based on current requirements from individual rooms.
- CU3-04M is also equipped with three Ethernet ports, one of which is used for connecting to Ethernet (100 Mbps) and two for CU3-04M wiring control units.
- CU3-04M has an TFT display that displays the current status and allows the setting of unit parameters such as network settings, date, time or the enabled service.
- Navigating the menus CU3-04M is possible using the directional buttons on the front panel.
- The execution of 2x 6-MODULE in the CU3-04M is designed for installation into switchboard on DIN rail EN60715.

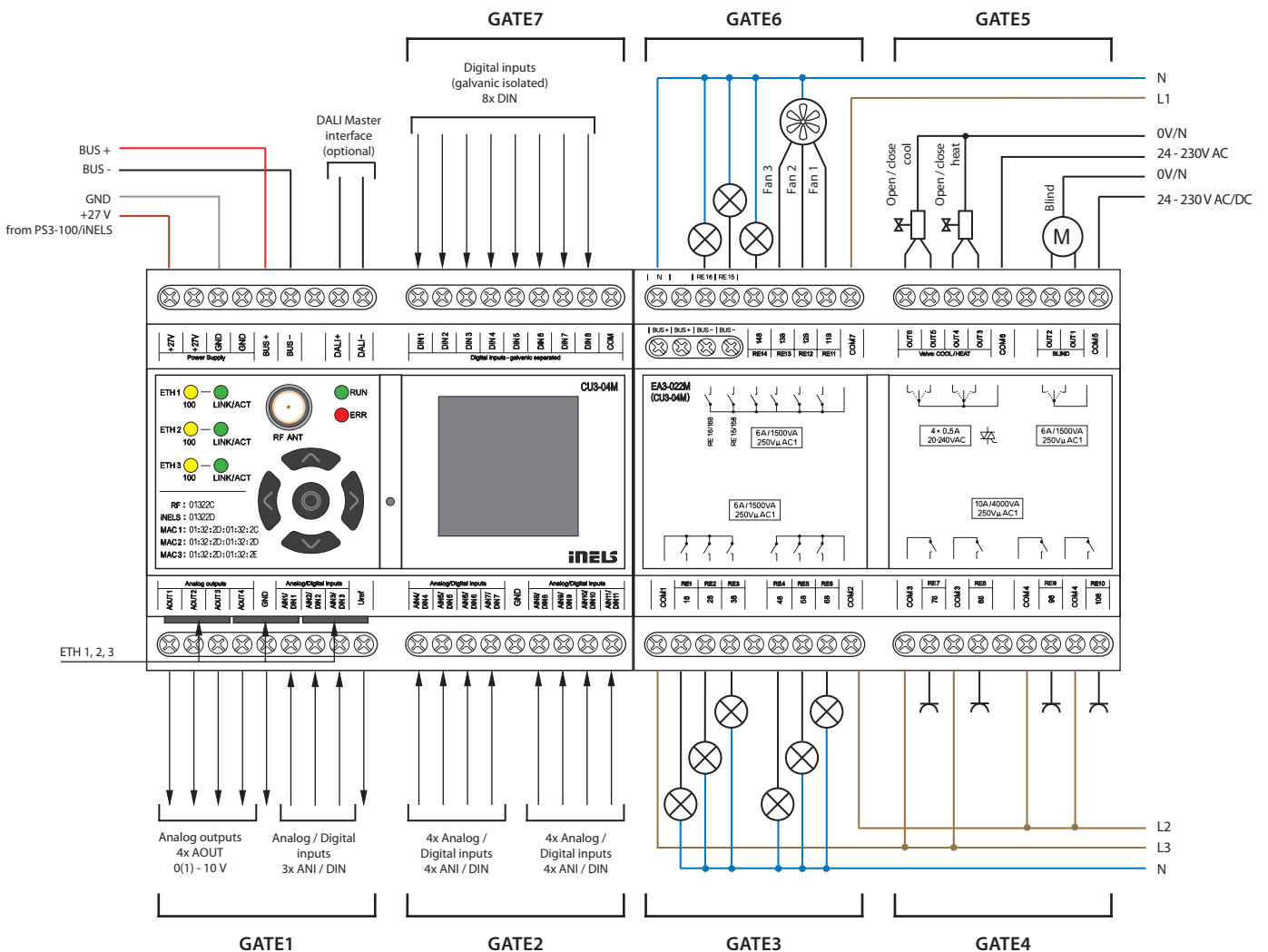

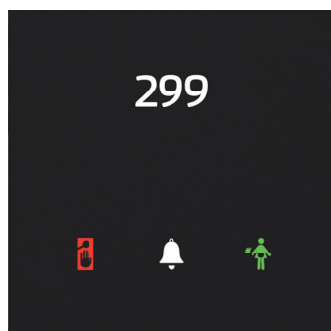

EAN code
GCR3-11/B: 8595188157476
GCR3-11/W: 8595188157483

Technical parameters	GCR3-11
Input	
Illuminance sensor:	1 ... 100 000 Lx
Buttons	
Number of control buttons:	3
Type:	Capacitive
Indication:	Coloured illuminated symbol
RFID readers	
Supported frequencies:	13.56 MHz
Card Type:	MIFARE Ultralight, DESFire 2K (EV1), DESFire 4K (EV1)
Outputs	
Signalling:	Do Not Disturb, Make Up Room
Output:	1x changeover 8 A / AgSnO ₂
Acoustic output:	piezo-changer
Tactile output:	Vibration motor
Switching voltage:	230V AC/ 30V DC
Switching output:	2000 VA/AC1; 240 W/DC
Peak current:	20 A/<3s
Insulation voltage between relay outputs and internal circuits:	3.75 kV, SELV according to EN 60950
Minimal switched current:	10 mA / 10 V
Switching frequency without load:	300 min ⁻¹
Switching frequency with rated load:	10 min ⁻¹
Mechanical life:	1x 10 ⁷
Electrical life AC1:	1x 10 ⁵
Communication	
Installation BUS:	BUS
Power supply	
Supply voltage / tolerance:	27 V DC, -20 / +10 %
Dissipated power:	max. 0.5 W
Rated current:	100-130 mA (at 27V DC), from BUS
Connection	
Data:	terminals, 0.5 - 1 mm ²
Network:	max. 2.5 mm ² /1.5 mm ² with sleeve
Operating conditions	
Relative humidity:	max. 80 %
Operating temperature:	-20 .. +55 °C
Storing temperature:	-30 .. +70 °C
Protection degree:	IP20
Overvoltage category:	II.
Pollution degree:	2
Operation position:	any
Installation:	into installation box
Dimensions and weight	
Dimensions:	94 x 94 x 36 mm
Weight:	161 g

- Glass RFID card reader GCR3-11 is part of a comprehensive range of glass iNELS control units and can be advantageously used in all projects, e.g. guest room management system (GRMS).
- GCR3-11 card reader is designed for reading smart cards, which are intended to enter the hotel room or any other part of the building.
- GCR3-11 supports RFID media with a carrier frequency of 13.56 MHz. Supported card types MIFARE Ultralight, DESFire 2K (EV1), DESFire 4K (EV1).
- The GCR3-11 is a design component of the iNELS system and is available in elegant black (GCR3-11/B) and white (GCR3-11/ W) variants.
- Input card reader is the first device of guest room management system (GRMS), with which the hotel guest comes into contact first and therefore was designed with an emphasis on representative design.
- Printing is possible to customize to the investor requirements. The room number as well as the logo of the hotel can be also printed on each component.
- The controller is also equipped with touch button with function of bell and with two icons to indicate the status of guest requests, e.g. "Do Not Disturb" and "Make Up Room", whose state guest can set from multi-function touch panel EHT3, glass card holder GCH3-31, glass switch buttons GSB3-20/S, GSB3-40/S, GSB3-60/S or such GSP3-100 glass switch panel.
- Individual symbols can be illuminated in one of seven colours - red, green, blue, yellow, pink, turquoise and white.
- Reader GCR3-11 is equipped with an 8A relay output with AgSnO₂ contact for door lock control.
- Reader GCR3-11 is equipped with a sensor for ambient light intensity. Based on information from the sensor it can e.g. switch the lighting circuits in the corridor.
- All versions are in the size of the module (94x94 mm) from the line of luxury switches and sockets LOGUS⁹⁰ and are therefore fully in line with the design of frames for the sockets of this series, where you can just as for the controllers choose white and black glass frames.
- GCR3-11 are designed for mounting into an installation box.

Connection

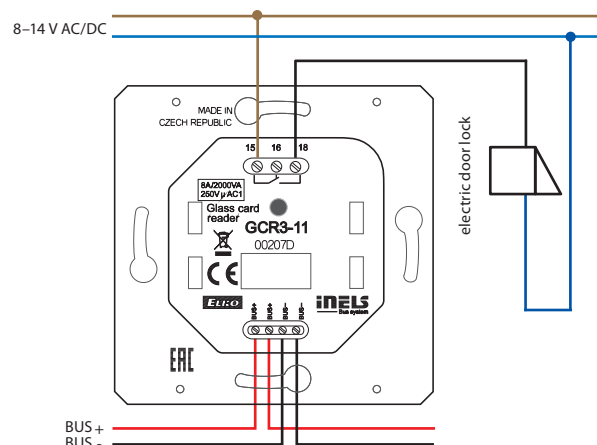

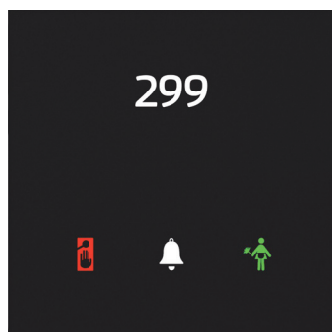

EAN code
GDB3-10/B: 85951881157261
GDB3-10/W: 8595188115728

Technical parameters

GDB3-10

Inputs

Temperature measuring:	YES, built-in temperature sensor
Scope and accuracy of temp. measuring:	0.. +55°C; 0.3°C from the range
Inputs:	2x AIN/DIN
Resolution:	by setting 10-bit
External temperature sensor:	YES, the connection between AIN1/DIN1 and AIN2/DIN2
Type of external sensor:	TC/TZ
Temperature measurement range:	-20°C to +120°C
Temperature measurement accuracy:	0.5°C from the range
Illuminance sensor:	1 ... 100 000 Lx

Buttons

Number of control buttons:	1
Type:	Capacitive
Indication:	Coloured illuminated symbol

Output

Signalling:	Do Not Disturb, Make Up Room
Acoustic output:	piezo-changer
Tactile output:	Vibration motor

Communication

Installation BUS:	BUS
-------------------	-----

Power supply

Supply voltage / tolerance:	27 V DC, -20 / +10 %
Dissipated power:	max. 0.5 W
Rated current:	100-120 mA (at 27V DC), from BUS

Connection

Terminals:	0.5 - 1 mm ²
------------	-------------------------

Operating conditions

Relative humidity:	max. 80 %
Operating temperature:	-20 .. +55 °C
Storing temperature:	-30 .. +70 °C
Protection degree:	IP20
Overvoltage category:	II.
Pollution degree:	2
Operation position:	on the wall, observing the conditions for correct installation of the thermostat
Installation:	into installation box

Dimensions and weight

Dimensions:	94 x 94 x 36 mm
Weight:	154 g

- Glass info panel GDB3-10 is part of a comprehensive series of glass iNELS control units for guest room management system (GRMS), and is used to indicate the status of guest requests "Do Not Disturb" and "Make Up Room".
- Thanks to the capacitive touch button, the info panel can also be used for the function of the bell.
- Glass info panel is a design component of the iNELS system and is available in elegant black (GDB3-10/B) and white (GDB3-10/W) version.
- Info panel printing is possible to customize to the investor requirements. The room number as well as the logo of the hotel can be also printed on each component.
- The "Do Not Disturb" or "Make Up Room" statuses can be entered by the hotel guest from a multi-functional touch panel EHT3, glass card holder GCH3-31, glass switch buttons GSB3-20/S, GSB3-40/S, GSB3-60/S or such GSP3-100 glass switch panel.
- All versions are in the size of the module (94x94 mm) from the line of luxury switches and sockets LOGUS⁹⁰ and are therefore fully in line with the design of frames for the sockets of this series, where you can just as for the controllers choose white and black glass frames.
- Info panel GDB3-10 is equipped with a sensor for ambient light intensity. Based on information from the sensor it can e.g. switch the lighting circuits in the corridor.
- Individual symbols can be illuminated in one of seven colours - red, green, blue, yellow, pink, turquoise and white.
- GDB3-10 are designed for mounting into an installation box.

Connection

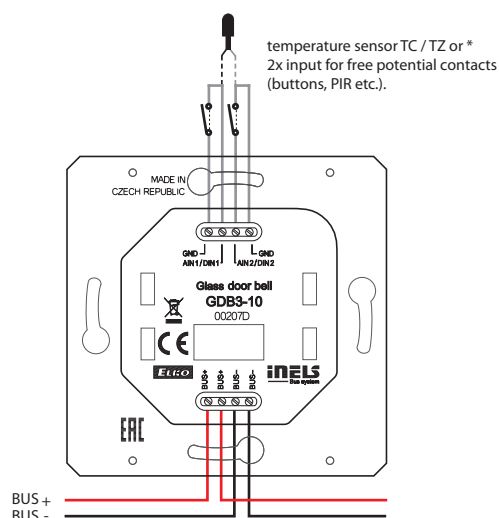

* The choice is made in iDM3 for each unit separately.

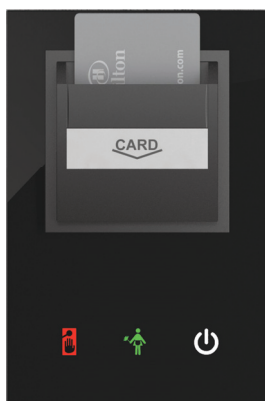

GCH3-31/B



GCH3-31/W

EAN code*

Technical parameters	GCH3-31
Input	
Illuminance sensor:	1 ... 100 000 Lx
Buttons	
Number of control buttons:	3
Type:	Capacitive
Indication:	Coloured illuminated symbol
RFID readers	
Supported frequencies:	13.56 MHz
Card Type:	MIFARE Ultralight, DESFire 2K (EV1), DESFire 4K (EV1)
Outputs	
Signalling:	Do Not Disturb, Make Up Room
Output:	1x changeover 8 A / AgSnO ₂
Acoustic output:	piezo-changer
Tactile output:	Vibration motor
Switching voltage:	230V AC/ 30V DC
Switching output:	2000 VA/AC1; 240 W/DC
Peak current:	20 A/<3s
Insulation voltage between relay outputs and internal circuits:	3.75 kV, SELV according to EN 60950
Minimal switched current:	10 mA / 10 V
Switching frequency without load:	300 min ⁻¹
Switching frequency with rated load:	10 min ⁻¹
Mechanical life:	1x 10 ⁷
Electrical life AC1:	1x 10 ⁵
Communication	
Installation BUS:	BUS
Power supply	
Supply voltage / tolerance:	27 V DC, -20 / +10 %
Dissipated power:	max. 2 W
Rated current:	100-120 mA (at 27V DC), from BUS
Connection	
Data:	terminals, 0.5 - 1 mm ²
Network:	max. 2.5 mm ² /1.5 mm ² with sleeve
Operating conditions	
Relative humidity:	max. 80 %
Operating temperature:	-20 .. +55 °C
Storing temperature:	-30 .. +70 °C
Protection degree:	IP20
Overvoltage category:	II.
Pollution degree:	2
Operation position:	any
Installation:	into installation box
Dimensions and weight	
Dimensions:	142 x 94 x 36 mm
Weight:	210 g

- Glass card holder GCH3-31 is part of a comprehensive range of glass iNELS control units for guest room management system (GRMS).
- GCH3-31 serves for inserting the RFID card into the holder, whereby the system acquires the information about whether the hotel guest is present in the room. With this information it is possible to ensure for example Exit function with relation to energy savings in the absence of a guest in the room.
- Glass card holder is a design component of the iNELS system and is available in elegant black (GCH3-31/B) and white (GCH3-31/W) version.
- The GCH3-31 component is equipped with an RFID reader and is thus able to identify the specific hotel card inserted. Power saving function in the absence of a guest cannot be bypassed by simply inserting business cards into the holder.
- GCH3-31 supports RFID media with a carrier frequency of 13.56 MHz. Supported card types are MIFARE Ultralight, DESFire 2K (EV1), DESFire 4K (EV1).
- The unit is also equipped with three touch buttons that can be used for example to set room status "Do Not Disturb" or "Make Up Room". This condition is then signalled to the glass card reader GCR3-11 or glass info panel GDB3-10 which are placed before the entrance to the room. Information may be sent directly to the hotel reception.
- Card holder printing is possible to customize to the investor requirements. The logo of the hotel can be shown for example. Likewise, it is also possible to adapt the card printing.
- The GCH3-31 unit is equipped with an 8A relay output and an AgSnO₂ contact.
- Individual symbols can be illuminated in one of seven colours - red, green, blue, yellow, pink, turquoise and white.
- GCH3-31 are designed for mounting into an installation box.

Connection

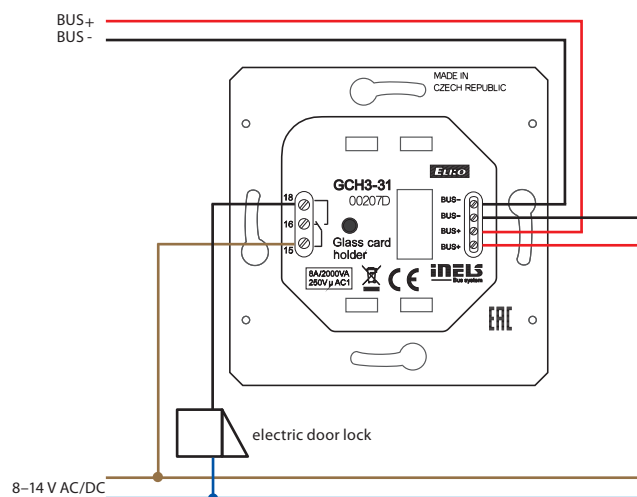

* Order codes of all colours are available in the iNELS price list.



EAN code*
EH T3 (white frame, white intermediate frame, white back cover): 8595188156196

Technical parameters	EH T3
Display	
Type:	colored TFT LCD
Aspect ratio:	3:4
Visible area:	52.5 x 70 mm
Backlight:	active
Touchpad:	4-wire resistive
Display:	3.5"
Number of points:	240 x 320
Color Depth:	16.7M (24 bit color)
Power supply	
Supply voltage / tolerance:	27 V DC, -20 / +10 %
Rated current:	150 mA (at 27V DC)
Connection	
Connection:	terminals
Connecting conductors profile:	max. 2.5 / 1.5 mm ² with sleeve
Operating conditions	
Operating temperature:	0 to +55°C
Storing temperature:	- 20 to +70°C
Protection degree:	IP20
Overvoltage category:	II.
Pollution degree:	2
Operating position:	any
Installation:	installation box
Dimensions and weight	
Dimensions:	94 x 94 x 36 mm
Weight**	127 g

* Order codes of all colours are available in the iNELS price list.
** Weight is listed with plastic frame.

- The control unit with touch screen EH T3 is a suitable control element for iNELS in places where it is required to control multiple devices. The unit replaces multiple controllers and allows minimisation of the number of switches on the wall.
- EH T3 control unit is also available in glass frames in black or white and is thus part of a comprehensive glass iNELS series of units for the management of the hotel rooms (GRMS).
- The EH T3 is primarily designed to control hotel rooms (Guest Room Management System), but it can also be used in other projects such as a multi-function control panel.
- EH T3 offers a user-friendly interface to control the hotel room; it was designed so that guests could easily create an environment that allows them to feel like home.
- Changing the Graphical Interface is possible in consultation with the manufacturer to adapt it to specific hotel, office building and restaurant projects.
- With the units it is possible to adjust the temperature (a version is available with the possibility to adjust the fan speed of fan coil units), light scenes, shading, music and it is also possible to transmit information "Do Not Disturb" and "Make Up Room"
- The unit enables the control of volume, choice of Internet radio stations from the LARA Radio player, as well as the ability to select TV channels.
- "Do Not Disturb" and "Make Up Room" information about the state of the rooms can be visualized on a GHR3-11 glass reader or GDB3-10 glass info panel, which is located in the corridor at the entrance to the room, and it is also possible to send the information of these events directly to the front desk to inform staff.
- EH T3 features a 3.5" color touchscreen with an aspect ratio of 3:4. The basic display resolution is 240 x 320 pixels. The color depth is 16.7 million colors (24 bit color, True Color).
- Using the sensor touchpad, buttons and symbols can be operated on the screen by a gentle touch of a finger. The symbols on the screen are by "pressing" animate an associated outlet in the system.
- EH T3 design is drawn into a row of instruments LOGUS⁹⁰ (EH T3 but you cannot install into multi-frames with other devices in this design) and is designed for mounting into installation box.

Connection

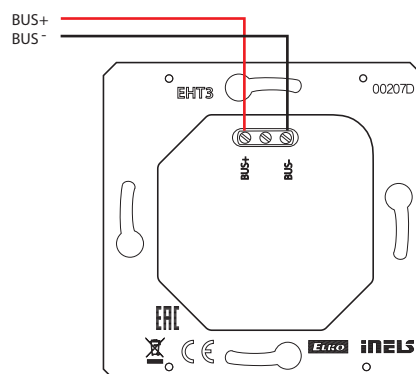

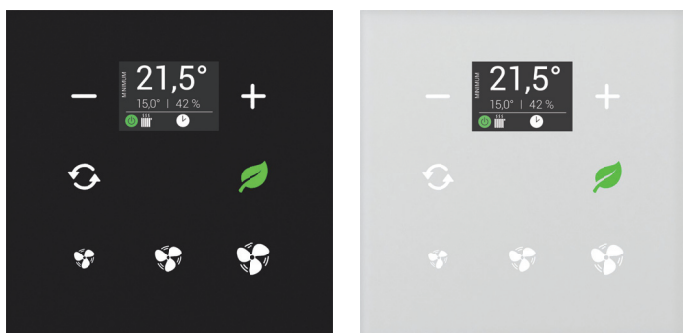

EAN code
 GRT3-50/B: 8595188156301
 GRT3-50/W: 8595188156349

Technical parameters GRT3-50

Inputs

Temperature measuring:	YES, built-in temperature sensor
Scope and accuracy of temp. measurement:	0.. +55°C; 0.3°C from the range
Humidity measurement:	YES
Humidity measurement range:	0 to 99% RH
Humidity measurement accuracy:	± 3 % Relative humidity
Inputs:	2x AIN/DIN
Resolution:	by setting 10-bit
External temperature sensor:	YES, the connection between AIN1/DIN1 and AIN2/DIN2
Type of external sensor:	TC/TZ
Temperature measurement range:	-20°C to +120°C
Temperature measurement accuracy:	0.5°C from the range

Buttons

Number of control buttons:	5
Type:	Capacitive
Indication:	Coloured illuminated symbol

Display

Display:	colored TFT, 20 x 25.5 mm
Resolution:	240 x 240 pixels

Outputs

Acoustic output:	piezo-changer
Tactile output:	Vibration motor

Communication

Installation BUS:	BUS
-------------------	-----

Power supply

Supply voltage / tolerance:	27 V DC, -20 / +10 %
Dissipated power:	max. 0.5 W
Rated current:	85 mA (at 27V DC), from BUS

Connection

Terminals:	0.5 - 1 mm ²
------------	-------------------------

Operating conditions

Relative humidity:	max. 80 %
Operating temperature:	-20 .. +55 °C
Storing temperature:	-30 .. +70 °C
Protection degree:	IP20
Overvoltage category:	II.
Pollution degree:	2
Operation position:	any
Installation:	on the wall, observing the conditions for correct installation of the thermostat

Dimensions and weight

Dimensions:	94 x 94 x 36 mm
Weight:	156 g

- Glass room thermo-regulator GRT3-50 is part of a comprehensive range of glass iNELS control units for guest room management system (GRMS) and serves to regulate the temperature in the room.
- GRT3-50 thermo-regulator has a display for displaying the current room temperature and desired temperature. To adjust the required temperature, it is possible to use the touch buttons with symbols "-" and "+".
- GRT3-50 is also suitable for controlling fan coils and fan speed can be easily adjusted by using the touch buttons with symbols.
- Thermo-regulator GRT3-50 also has a further two touch buttons whose function can be adjusted by software, for example fan coil on/off, heating/cooling or comfort temperature for heating or cooling.
- Thermo-regulator is equipped with an integrated temperature sensor for ambient temperature measurement.
- The glass room thermo-regulator is a design component of the iNELS system and is available in elegant black (GRT3-50/B) and white (GRT3-50/W) version.
- Printing is possible to customize to the investor requirements.
- Individual symbols can be illuminated in one of seven colours - red, green, blue, yellow, pink, turquoise and white.
- GRT3-50 are designed for mounting into an installation box.

Connection

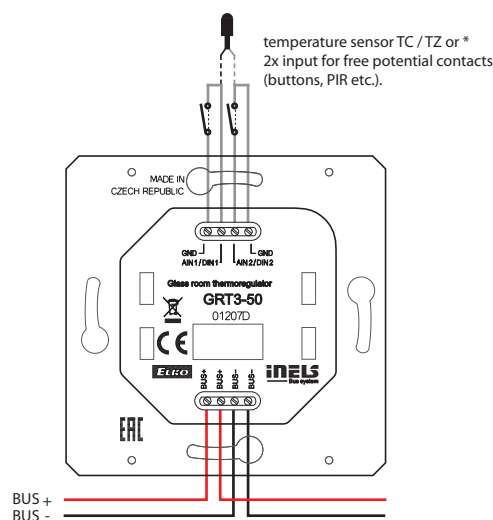

* The choice is made in iDM3 for each unit separately.

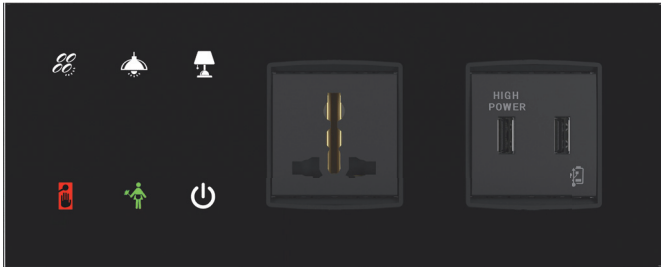

GBP3-60R/B

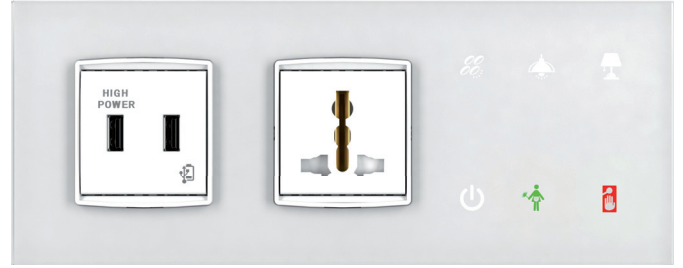

GBP3-60L/W

EAN code*

Technical parameters	GBP3-60
Inputs	
Inputs:	2x AIN/DIN
Resolution:	by setting 10-bit
External temperature sensor:	YES, the connection between AIN1/DIN1 and AIN2/DIN2
Type of external sensor:	TC/TZ
Temperature measurement range:	-20°C to +120°C
Temperature measurement accuracy:	0.5°C from the range
Illuminance sensor:	1 ... 100 000 Lx
Buttons	
Number of control buttons:	6
Type:	Capacitive
Indication:	Coloured illuminated symbol
Outputs	
Acoustic output:	piezo-changer
Tactile output:	Vibration motor
Communication	
Installation BUS:	BUS
Power supply	
Supply voltage / tolerance:	27 V DC, -20 / +10 %
Dissipated power:	max. 0.5 W
Rated current:	25-50 mA (at 27V DC), from BUS
Connection	
Terminals:	0.5 - 1 mm ²
Operating conditions	
Relative humidity:	max. 80 %
Operating temperature:	-20 .. +55 °C
Storing temperature:	-30 .. +70 °C
Protection degree:	IP20
Overvoltage category:	II.
Pollution degree:	2
Operation position:	any
Installation:	on the wall, observing the conditions for correct installation of the thermostat
Dimensions and weight	
Dimensions:	GBP3-60/1F: 165 x 94 x 36 mm, GBP3-60/2F: 236 x 94 x 36 mm
Weight:	according to the selected module

- Glass bedside panel GBP3-60 is part of a comprehensive range of iNELS control units for guest room management system (GRMS). Bedside panel is composed from three modules, of which one is module of touch buttons and two are modules to power for example mobile devices.
- The GBP3-60 is available in several designs, making it a very flexible and effective solution for a variety of projects. The following variants are available:
 - Left / Right version provides the same ease of operation from both sides of the bed.
 - 2-module (1F) / 3-module (2F) design enables you to add a touch module with one or two power supply modules, network connection or multimedia.
 - Black / White elegant design suitable for almost any interior.
- GBP3-60 panel is equipped with six customizable touch buttons whose function can be software adapted to the requirements of the investor. Of course there is the possibility of using the "Master OFF", then you can select functions for switching and dimming of lighting, shading control, different scenarios etc.
- Printing is possible to customize to the investor requirements.
- GBP3-60 can be equipped with a number of modules, for example.
 - Power AC sockets: French, British, Multi, and Shockproof
 - Other types of modules: USB, LAN, Media
- The GBP3-60 panel is equipped with an ambient light sensor.
- Individual symbols can be illuminated in one of three colours - red, green and blue.
- GBP3-60/1F is designed for mounting into a double mounting box, GBP3-60/2F to a triple mounting box (distance between the centres of each of openings is 71 mm).

Connection

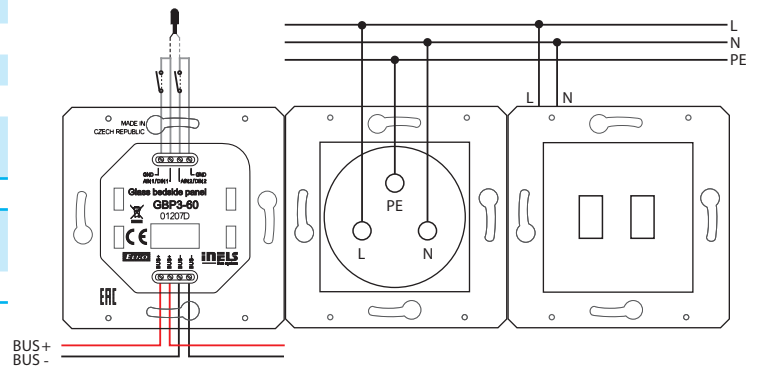

* Order codes are available in the iNELS price list.

Switch

Push button

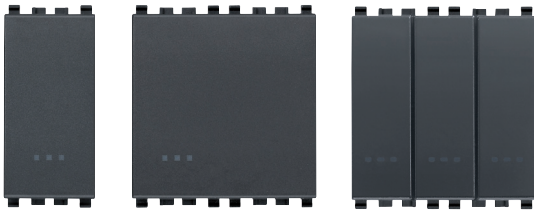
One switch
/ 1MOne switch
/ 2MThree
switches

11B (20001)

12B (20001.2)

14B (20003)

11W (20001.B)

12W (20001.2.B)

14W (20003.B)

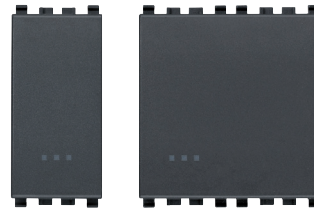
One Push button
/ 1MOne Push button
/ 2M

49B (20008)

50B (20008.7)

49W (20008.B)

50W (20008.7.B)

Socket

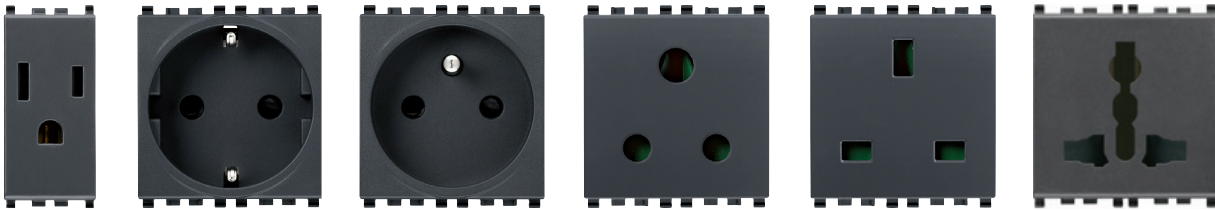
USA
outletSchuko
outletFrench
outlet3 PIN
outletBritish
outletMultistandard
outlet

21B (20242)

22B (20208)

23B (20212)

24B (20214)

25B (20219)

26B (20257)

21W (20242.B)

22W (20208.B)

23W (20212.B)

24W (20214.B)

25W (20219.B)

26W (20257.B)

Data & Audio/Video

USB power
supply unitTV-FM-SAT socket
outletVGA
connector

20B (20295)

31B (20303)

32B (20348)

20W (20295.B)

31W (20303.B)

32W (20348.B)

TV
outletPhone
outletA/V
connectorsUTP
outletUSB
supply unitSwitch
(CBs)HDMI
connectorUSB
outlet

41B (20313)

42B (20320)

43B (20335)

44B (20337.6)

48B (20292)

46B (20405.06)

47B (20346.H)

45B (20345)

41W (20313.B)

42W (20320.B)

43W (20335.B)

44W (20337.6.B)

48W (20292.B)

46W (20405.06.B)

47W (20346.H.B)

45W (20345.B)

(Number in brackets is original Vimar product code)

Glass Bedside Panel

Configure bedside panel according to your request.

L (left option)

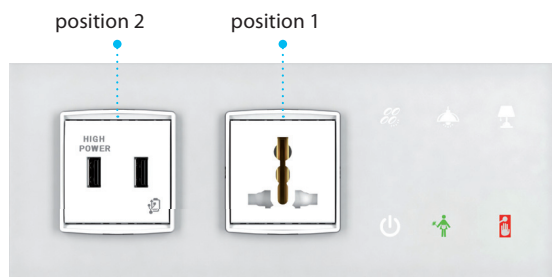

GBP3-60/WL/2F-26W-20W

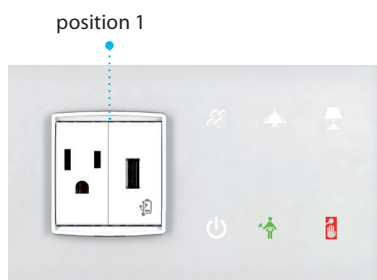

GBP3-60/WL/1F-21W45W

R (right option)

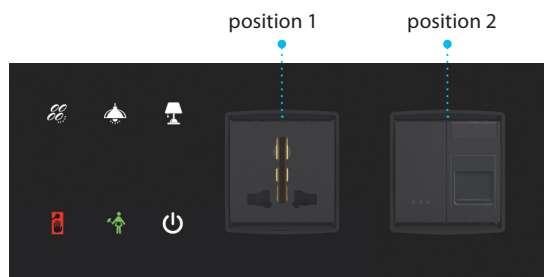

GBP3-60/BR/2F-26B-11B44B

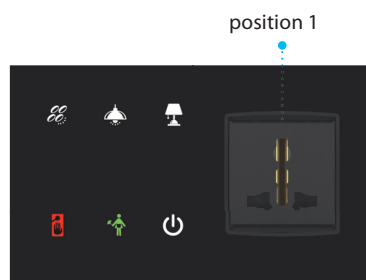

GBP3-60/BR/1F-26B

Part number

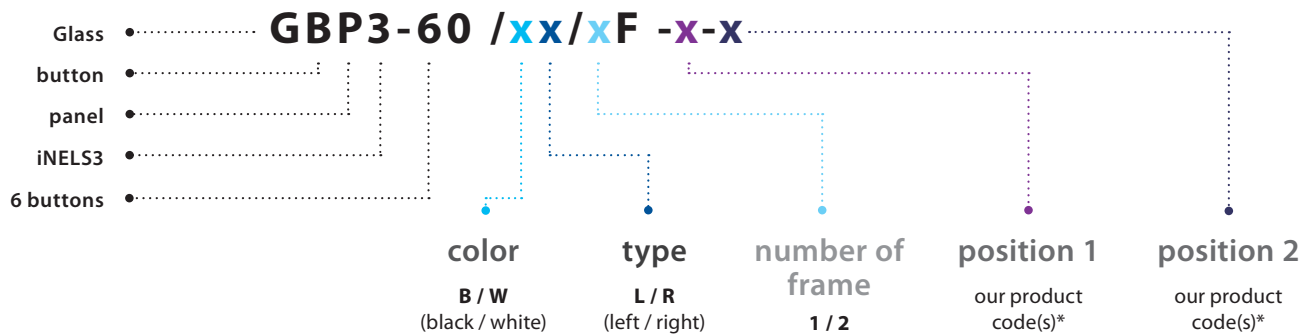

* In case of 1-module choice it is necessary to pick **2x** 1-module to fill up the 1 position, for example GBP3-60/WL/1F-21W45W.

Classic plate



Glass white ice
/ 2M



Glass black ice
/ 2M



Glass black ice
/ 3M



Glass black ice
/ 4M

If you have any question contact our sales representative.
 For more information: www.vimar.com/en/int/catalog/product

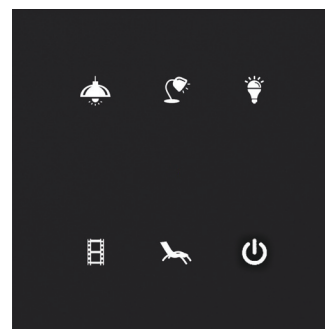
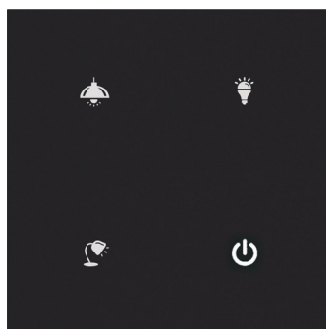
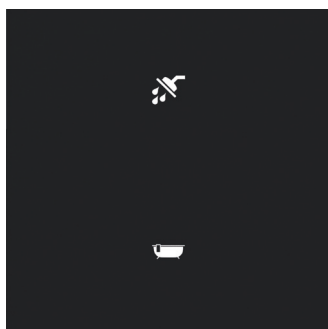

EAN code
 GSB3-20/SB: 8595188156219
 GSB3-40/SB: 8595188156233
 GSB3-60/SB: 8595188156257

Technical parameters GSB3-20/S GSB3-40/S GSB3-60/S

Inputs			
Temperature measuring:	YES, built-in temperature sensor		
Scope and accuracy of temp. measurement:	0.. +55°C; 0.3°C from the range		
Inputs:	2x AIN/DIN		
Resolution:	by setting 10-bit		
External temperature sensor:	YES, the connection between AIN1/DIN1 and AIN2/DIN2		
Type of external sensor:	TC/TZ		
Temperature measurement range:	-20°C to +120°C		
Temperature measurement accuracy:	0.5°C from the range		
Illuminance sensor:	1 ... 100 000 Lx		
Buttons			
Number of control buttons:	2	4	6
Type:	Capacitive		
Indication:	Coloured illuminated symbol		
Outputs			
Acoustic output:	piezo-changer		
Tactile output:	Vibration motor		
Communication			
Installation BUS:	BUS		
Power supply			
Supply voltage / tolerance:	27 V DC, -20 / +10 %		
Dissipated power:	max. 0.5 W		
Rated current:	25-35 mA	25-43 mA	25-50 mA (at 27V DC), from BUS
Connection			
Terminals:	0.5 - 1 mm ²		
Operating conditions			
Relative humidity:	max. 80 %		
Operating temperature:	-20 .. +55 °C		
Storing temperature:	-30 .. +70 °C		
Protection degree:	IP20		
Overvoltage category:	II.		
Pollution degree:	2		
Operation position:	any		
Installation:	on the wall, observing the conditions for correct installation of the thermostat		
Dimensions and weight			
Dimensions:	142 x 94 x 36 mm		
Weight:	154 g		

- Glass touch controllers with symbols GSB3-20/S, GSB3-40/S and GSB3-60/S are part of a comprehensive range of glass iNELS control units and can be advantageously used in all projects for example as a part of guest room management system (GRMS).
- GSB3-20/S is equipped with two, GSB3-40/S with four and GSB3-60/S six touch buttons whose functions can easily modify by the software.
- Printing is possible to customize to the investor requirements.
- Individual symbols can be illuminated in one of seven colours - red, green, blue, yellow, pink, turquoise and white.
- Glass touch panel is a design component of the iNELS system and is available in elegant black (GSB3-20/SB, GSB3-40/SB, GSB3-60/SB) and white (GSB3-20/SW, GSB3-40/SW, GSB3-60/SW) versions.
- All versions are in the size of the module (94x94 mm) from the line of luxury switches and sockets LOGUS⁹⁰ and are therefore fully in line with the design of frames for the sockets of this series, where you can just as for the controllers choose white and black glass frames.
- The glass touch controllers is equipped with an integrated temperature sensor. It is also equipped with two analog-to-digital inputs (AIN/ DIN), which can be used to connect two potential-free contacts or one external temperature sensor TC/TZ (for example temperature measurement of the floor).
- The glass touch controllers are also equipped with a sensor of ambient light intensity. Based on information from the sensor it can switch backlight of symbols or perform various actions in the iDM3 software, for example also switch the lighting circuits in the room.
- Advantages over conventional switches / buttons are saving space, signalling the state of any system output, the ability to measure temperature as well as the ability to connect external buttons or detectors.
- Each button can control any actuator (appliance) in the system. Also, you can assign each button a different function or macro (set of functions). It is therefore possible to use one button to control several appliances at once.
- GSB3-20/S, GSB3-40/S, and GSB3-60/S are designed for mounting into an installation box.

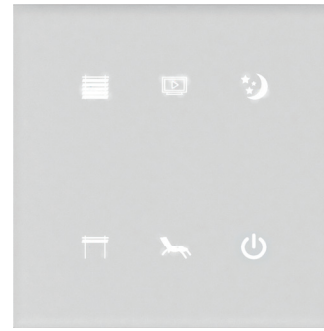

EAN code
 GSB3-20/SW: 8595188156226
 GSB3-40/SW: 8595188156240
 GSB3-60/SW: 8595188156264

Connection

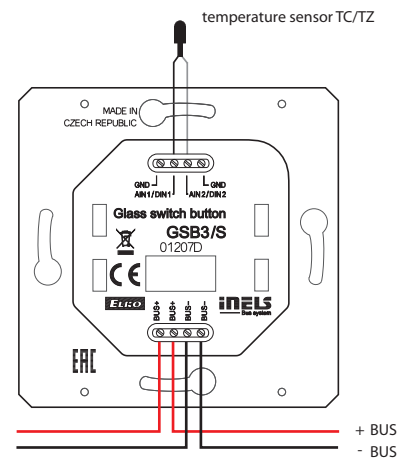
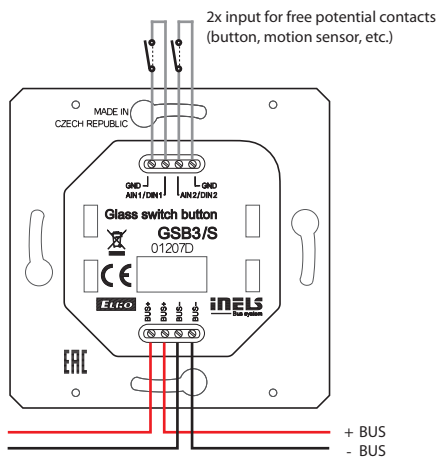

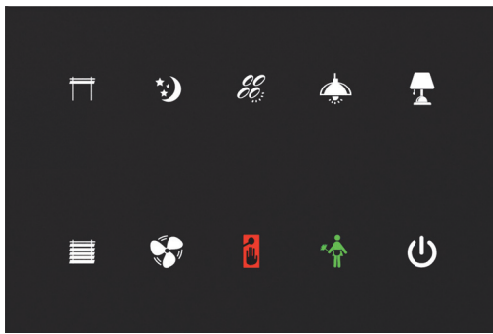

EAN code*
 GSP3-100/B: 8595188156288
 GSP3-100/W: 8595188156325

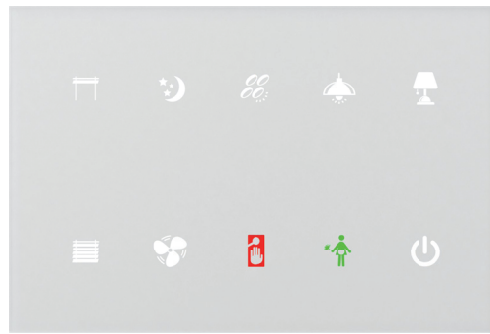

Technical parameters GSP3-100

Inputs	
Temperature measuring:	YES, built-in temperature sensor
Scope and accuracy of temp. measurement:	0.. +55°C; 0.3°C from the range
Inputs:	2x AIN/DIN
Resolution:	by setting 10-bit
External temperature sensor:	YES, the connection between AIN1/DIN1 and AIN2/DIN2
Type of external sensor:	TC/TZ
Temperature measurement range:	-20°C to +120°C
Temperature measurement accuracy:	0.5°C from the range
Buttons	
Number of control buttons:	10
Type:	Capacitive
Indication:	Coloured illuminated symbol
Outputs	
Acoustic output:	piezo-changer
Tactile output:	Vibration motor
Communication	
Installation BUS:	BUS
Power supply	
Supply voltage / tolerance:	27 V DC, -20 / +10 %
Dissipated power:	max. 0.5 W
Rated current:	25-65 mA (at 27V DC), from BUS
Connection	
Terminals:	0.5 - 1 mm ²
Operating conditions	
Relative humidity:	max. 80 %
Operating temperature:	-20 .. +55 °C
Storing temperature:	-30 .. +70 °C
Protection degree:	IP20
Overvoltage category:	II.
Pollution degree:	2
Operation position:	any
Installation:	on the wall, observing the conditions for correct installation of the thermostat
Dimensions and weight	
Dimensions:	142 x 94 x 36 mm
Weight:	208 g

- Glass Touch Panel GSP3-100 is part of a comprehensive iNELS series of units for the management of the hotel rooms (GRMS), but the unit can be used wherever it is required to control multiple devices from one location.
- GSP3-100 is equipped with ten touch buttons whose functions can easily be edited using the software.
- The graphics of individual symbols are possible based on consultations with manufacturers to change and adapt to the requirements of the investor.
- Individual symbols can be any one of seven backlight colours - red, green, blue, yellow, pink, turquoise and white.
- Glass touch panel is a design component of the INELS system and is available in elegant black (GSP3-100/B) and white (GSP3-100/W) versions.
- Compared with standard glass touchscreen controllers with symbols GSB3-20/SB, GSB3-20/SW, GSB3-40/SB, GSB3-40/SW, GSB3-60/SB and GSB3-60/SW the GSP3-100 is one and a half times the width.
- The touch panel is equipped with an integrated temperature sensor. It is also equipped with two analogue-to-digital inputs (AIN/DIN), which can be used to connect two potential free contacts or one external temperature sensor TC / TZ (e.g. For measuring the temperature of the floor).
- The touch panel is also equipped with an ambient light intensity sensor. Based on information from the sensor it can light up indicative illumination symbols or perform various actions with the iDM3 software, e.g. To also switch the lighting circuits in the room.
- Advantages over conventional switches / buttons is saving space, signalling the state of any system output, the ability to measure temperature and an option to connect external pushbuttons or detectors.
- Each button can control any actuator (appliance) in the system. Also, you can assign a different function or macro (set of functions) to each button. It is therefore possible to use one button to control several appliances.
- GSP3-100 is designed for mounting into an installation box.

Connection

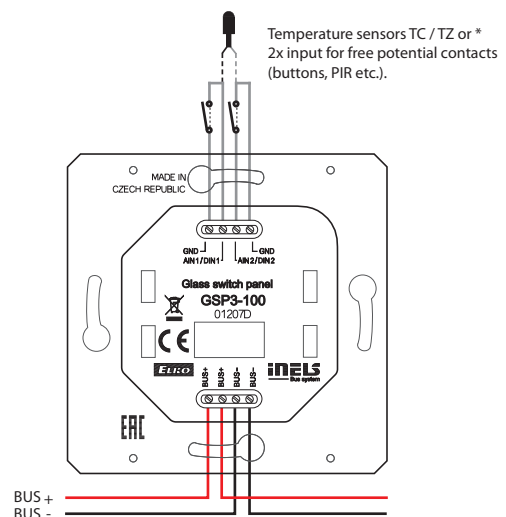

* The choice is made in iDM3 for each unit separately.

Building Management System

Modern solutions for house and building projects.



www.inels.com

INELS[®]

INELS NIAGARA

powered by
niagara
 framework®

Buildings today are equipped with an array of systems to control HVAC (heating, ventilation and air conditioning), lighting, shading, security, GRMS (Guest Room Management System), energy management, emergency lighting, fire alarms, CCTV, access control systems, elevators and other technologies. Effective integration and communication among the various systems in the building is critical to creating a comfortable environment for all users, to reduce building operation costs and reduce carbon dioxide emissions required for the operation of buildings. iNELS is a great solution for a variety of jobs, particularly in the areas of lighting, shading and GRMS (Guest Room Management System), and thanks to its modular and flexible topology it is used in commercial projects of hotels, office buildings, restaurants, wellness centres or manufacturing plants and warehouses.

iNELS is fully compatible with BMS (Building Management System) Niagara platform, which provides a convenient and efficient user interface for all - investors, management, users, operators and system integrators. iNELS Niagara enables the integration of dozens of iNELS central units and all other protocols that are installed within buildings. There are controllers for the actual control of all processes in the building. Supervisor licenses for the deployment on the operator's computer are used to supervise the operation of the system, receiving alarms and notifications and evaluation of historical data and graphs. Thanks to its wide range of possible operating pre-sets, iNELS Niagara allows to achieve the most economical operation of the building. User interface uses a very efficient modern design language and using of templates greatly reduces the required integration time.



CORE FEATURES:

A wide range of logical function blocks

iNELS Niagara offers integrators dozens of function blocks for solving a variety of tasks within the building management. Function blocks are also divided into clear categories for easy navigation.

Supports virtually all universal protocols

iNELS Niagara is really versatile and supports dozens of universal and proprietary protocols, all the data points converted to a universal form, allowing truly free integration between all protocols.

Support for HTML5

By leveraging HTML5 iNELS Niagara offers a simple interface that eliminates the need to install various plugins. A unified user interface is available for all platforms - PC, tablet or mobile phone.

Advanced visualization

Part of iNELS Niagara is an extensive graphics library for creating modern and well-arranged visualizations depicting the current state of the controlled technology.

Creating graphs / trends

Part of the visualizations is graphs that enable easy insertion of the monitored data to a chart by using "drag and drop" allowing more transparent comparison of values and storing graphs for later use.

Customizable dashboards

Within the visualizations, dashboards are widely supported, which can also be accessed with dependant on the user rights and users are able to adapt these dashboards, e.g. monitored variables, according to their requirements. Each user can inspect the operation of buildings from different view and iNELS Niagara freely enables effective adaptation.

Management of alarms and notifications

Sophisticated alarm and notification management including the ability to send information via e-mail. Alarms can be backed up and user notes can be inserted to the individual alarms, for example on how to resolve the situation.

Energy analysis

Energy management and cost analysis is the most important part of building management and iNELS Niagara offers tremendous opportunities for monitoring and evaluation of the parameters that are energy related.

Archive logs and historical data

All historical data and logs can be stored at freely selectable intervals. The big advantage of iNELS Niagara is that it allows all alarms, logs, visualization, calendars and configuration to be done by remote using a standard Web browser.

Encrypted communication

Authentication requires the use of very strong credentials and all data communication is encrypted and this area is with the advent of the Internet of things (IoT) is given maximum attention.

Wide range of access for rights management

The big advantage of this solution is the iNELS Niagara control access based on user roles, which enables users to perform only the well-defined actions given. All changes and events are also logged and stored for possible evaluation.

Efficient navigation through the use of tags

Utilising tags streamlines the entire process, from configuration to management of the whole system. Using tags in combination with templates can significantly reduce configuration time; tags facilitate access control based on user rights, navigation in the whole project and user customization in the visualization.

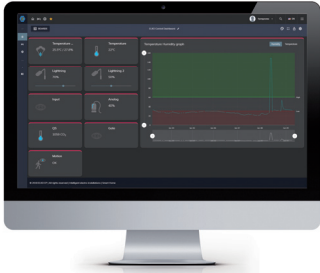

PC



Notebook



Tablet



Smartphone

BMS
Building management system

powered by
niagara
framework®



iNELS BMS



XML

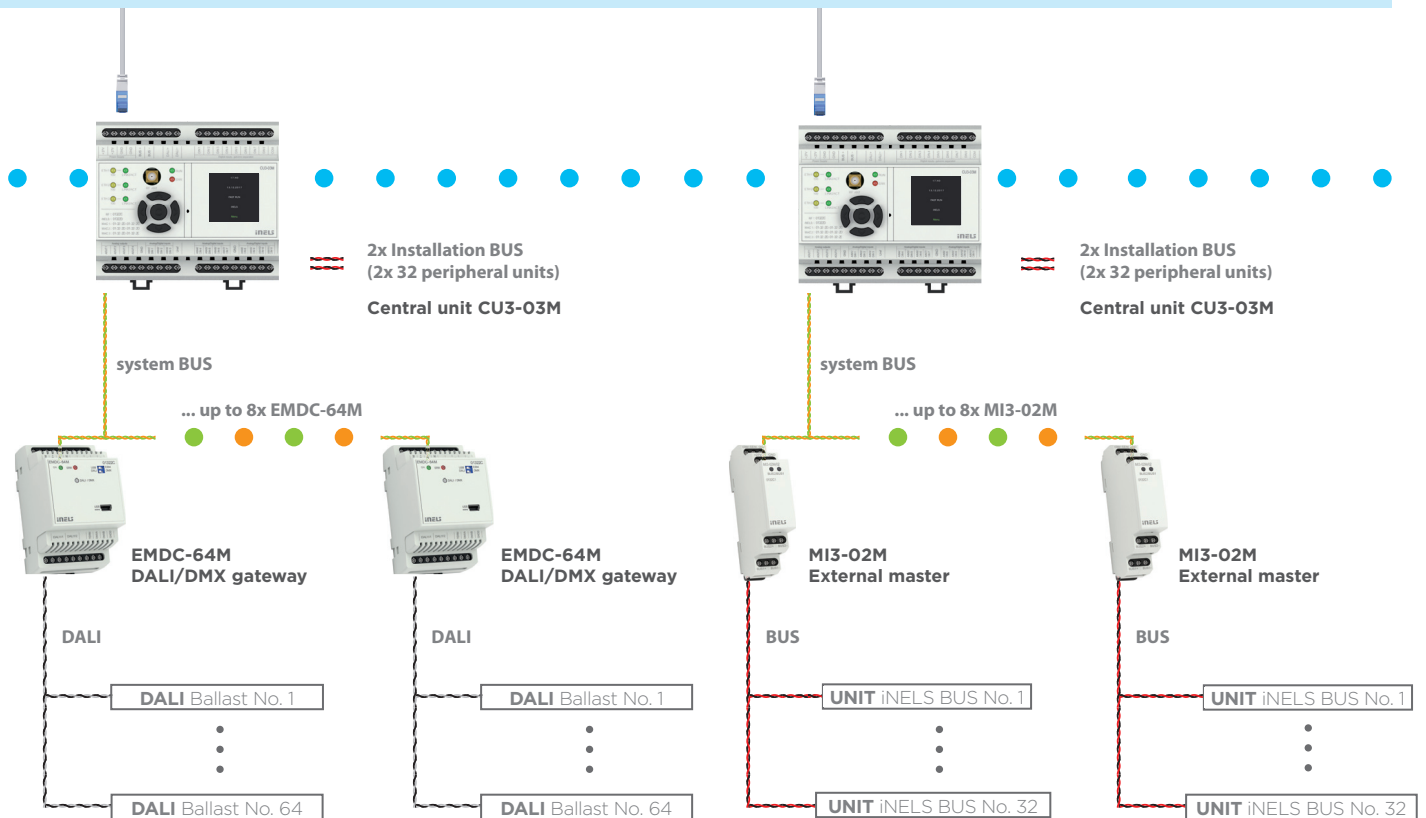

AVAILABLE PROTOCOLS: *



* A complete list can be found on www.inels.cz.

Multimedia

Modern solutions for house and building projects.





- 10" touch panel designed to control iNELS.
- Black aluminum frame chassis in combination with glass.
- Integrated speakers and microphone are primarily designed for intercom operation.
- Connection to the local area network can be done with Ethernet connection with PoE power supply – Active PoE (IEEE 802.3af).
- Android for iHC (iNELS Home Control) applications or Future office applications.
- Update applications over the Internet.
- Active PoE power.
- The panel also includes a cover that also serves as a mounting frame.

EAN code
iTP 10"/A: 8595188135382
iTP 10"/FO: 8595188135412

Technical parameters		iTP 10"
Display		
Type:	color TFT LCD	
Resolution:	1280 x 800 dots / 16.7 M	
Aspect ratio:	16:10	
Visible area:	217 x 135 mm	
Backlight:	Active (white LEDs)	
Touch screen:	Capacitive	
Diagonal:	10.1"	
Control:	touch	
Viewing Angle:	± 85 °	
Power supply		
Supply voltage:	PoE IEEE 802.3af (Active PoE)	
Power consumption:	max. 12 W	
HW		
CPU:	A20 ARM Cortex-A7 DUAL-CORE	
RAM:	1GB DDR3 SDRAM	
SD card:	Android / booking system (Future office)	
Network:	LAN: 10/100	
AUDIO:	Microphone, speakers	
Connections:	PoE power connector - RJ45	
Operating conditions		
Operating temperature:	0 .. +50 °C	
Storing temperature:	- 20 .. +70 °C	
Protection degree:	IP20	
Overvoltage category:	III.	
Pollution degree:	2	
Operation position:	any	
Installation:	Into the pre-prepared opening anywhere in the interior (245 x 160 x 30 mm) / with the appropriate installation frame as well as the glass	
Dimensions:	325 x 174 x 35 mm	
Weight:	1226 g	





EAN code
Connection Server: 8595188149204

Technical parameters	Connection Server
Connection:	MicroUSB 5V / MicroUSB 5V/2A
Video Output:	HDMI
Audio Output:	3.5 mm stereo JACK out
Processor (CPU):	1.2 GHz, 64-bit quad-core, ARM Cortex-A 53
Memory (SDRAM):	1 Gb
Communication Interface:	ethernet port 10/100 Mbps (RJ45)
Connecting peripherals:	4x USB 2.0
Dimensions:	100.6 x 73.5 x 26.5 mm

- The connection server is providing a communication environment between iNELS BUS System with the third party devices, for which their protocols are also translated and submitted.
- The iHC application's environment enables us to control all these technologies from just one app.
- The inclusion Connection Server to the system can be controlled from the application iHC except BUS units (lighting, blinds, heating, etc.) also IP cameras, air conditioning, recuperation or domestic appliances Miele.
- It also allows the communication with the domestic voice intercom 2N. It can also arrange the information from the weather station Giom or data from energy meters (electricity, water, gas), which is visualized in clear graphs.
- The device connection server uses the Raspberry Pi hardware and the apps requires a license relative to the MAC address of the device.
- While connecting with the devices connection server, it's recommended to use an uninterruptible power supply (UPS), which ensures that, there will be no power outage.
- As a part of the package, we also included an SD card where we previously installed Linux OS on it and its needed software equipment.
- The configuration is happening on its own web interface, where the default IP address is not fixed. (The IP address is assigned from the DHCP server and it's needed to be known when we're connected to the network).

These protocols are being translated:

- XML RPC (for communication with iHC applications, Connection Server controls access to the central unit of iHC applications and allows access to it from multiple devices).
- ELKONET (for communication with the iNELS central unit).
- Miele@home 2.0 (for the communication with Miele Gateway and the domestic needs).
- VAPIX2, VAPIX3, ONVIF for cameras (which enables streaming up to 9 camera pictures together, PTZ controlling, recording on a network drive).
- Coolmaster (for communication with AC Daikin VRV, Sanyo VRF, Toshiba VRF, Mitsubishi Electric VRF, LG VRF, Fujitsu VRF, Mitsubishi Heavy VRF, Hitachi VRF).
- Atrea, AirPohoda (recuperation).
- NILAN (indoor climate solutions).
- SIP for domestic voice communication, for example: 2N (a communication between the iHC app or between individual iHC apps - VoIP).
- Giom3000 (displaying values from the weather station in the iHC app and using the information about the temperature, humidity and wind speed to an subsequent event, for example removing the shutters).

Infrastructure example

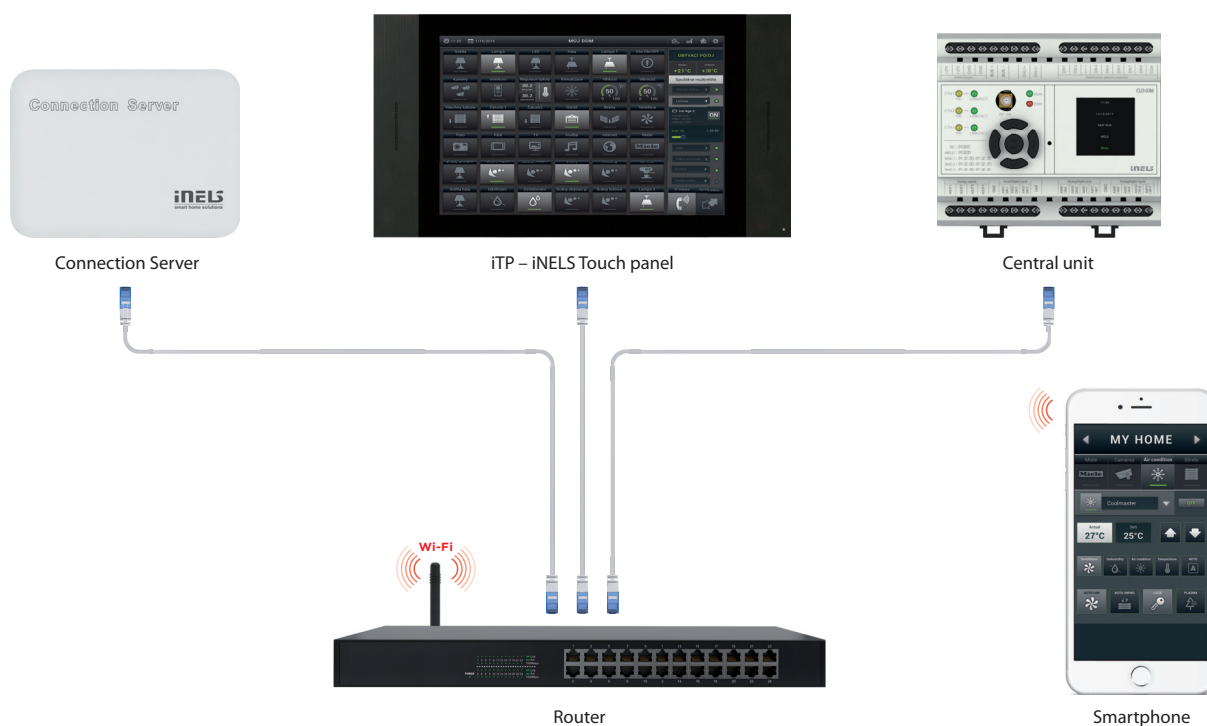



EAN code
iMM Audio Zone-R: 8595188150125

Technical parameters	iMM Audio Zone-R
Connection:	MicroUSB 5V / MicroUSB 5V/2A
Video Output:	HDMI
Audio Output:	3.5 mm stereo JACK out
Communication Interface:	Ethernet port 10/100 Mbps (RJ45)
Connecting peripherals:	4x USB 2.0
Dimensions:	100.6 x 73.5 x 26.5 mm

- The iMM Audio zone-R serves as a player for the other Audio zones where we also can integrate the iMM server to the iNELS system.
- The iMM Audio zone-R allows us to play music which is stored on the network storage, which by itself could be an NAS (Network Attached Storage), for example: Synology.
- The music is being played through the Logitech Media Server.
- We can control every iMM Audio zone-R in the system using the iHC application in any smart phone or a tablet, possibly from the iMM application TV picture (Video zone).
- The Audio zone is equipped with a stereo jack of 3.5mm output for supplying to the amplifier or active speakers.
- The Audio zone can be connected via an HDMI to a TV or a monitor with speakers and play music within these devices.
- An HDMI output for the connection of the monitor to determine the IP address service (see the instructions).
- 2x USB ports, for example for connecting a keyboard during the IP address determination process.
- 1x RJ45 for the connection to the computer or to an Ethernet Network.
- The configuration is done on their own web interface with the default IP address 192.168.1.220 (see separate manual, which is available on the product packaging and www.elkoep.cz and www.inels.cz).
- As a part of the package, we also included an SD card where we previously installed Linux OS on it and its needed software equipment.

Infrastructure example

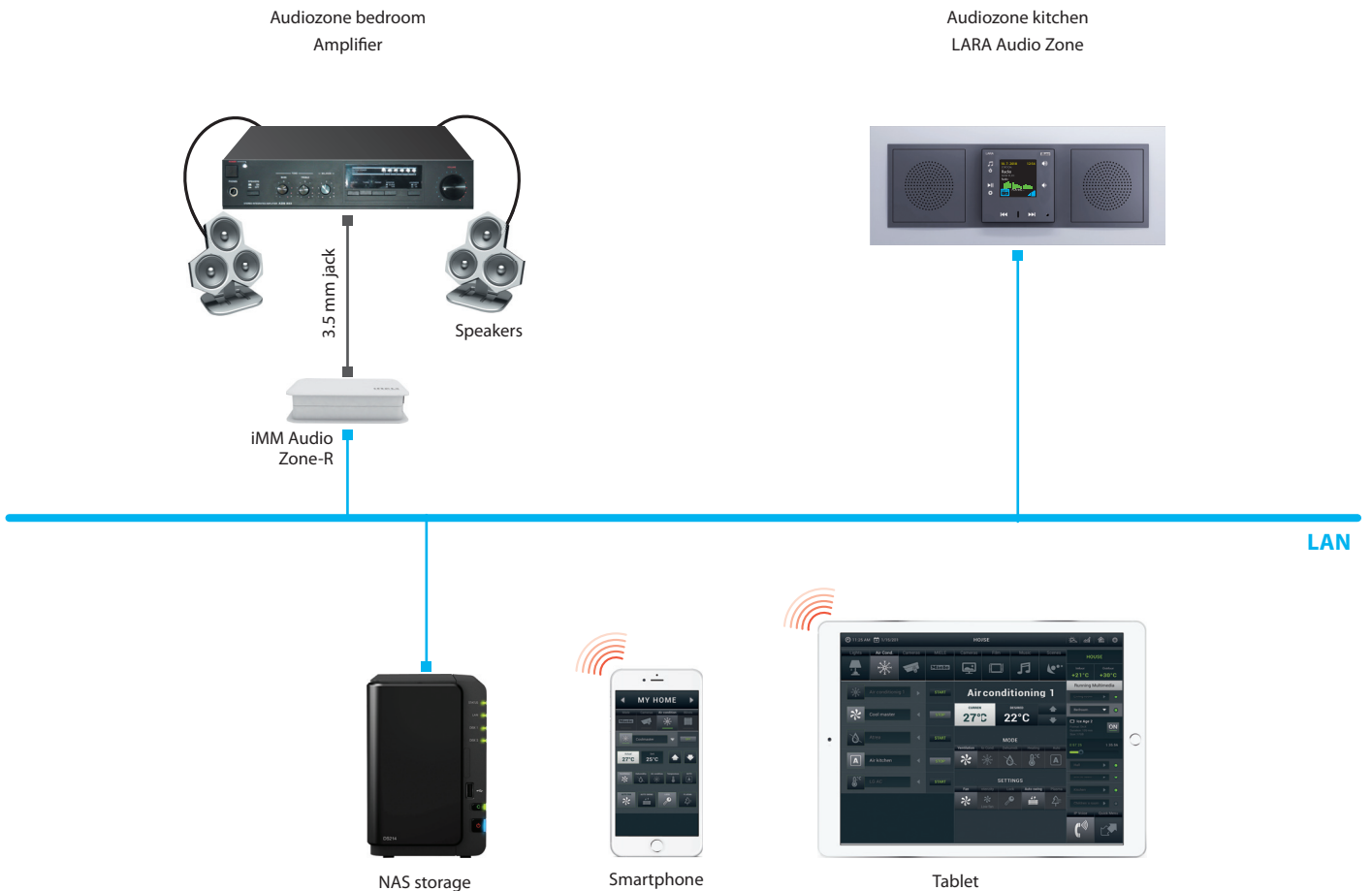



EAN code
eLAN-IR-003: 8595188132831

Technical parameters

eLAN-IR-003

Senzor IR - learning mode

Senzor IR:	Infrared sensor for learning IR codes
The carrier IR frequency:	20 - 455 kHz
Learning distance:	till 1m

Outputs

Output:	3x IR transmitter
Connection:	3x 3.5 Jack connector, cable length 3 m
Output indication:	3x LED green status IR1-IR3
Range:	Up to 1m from the device

Ethernet communication

Indication of ETH operating status:	Green LED
Indic. of ETH communication:	Yellow LED
Communication Interface:	10/100 Mbps (RJ45)
Default IP address:	192.168.1.1

Power supply

Voltage supply / jm. current:	10-27 V DC / 200 mA (safe low voltage)
Connection:	Jack connector Ø 2.1 mm
Voltage supply indication:	Green LED

Other data

Other possibilities of wiring:	USB-B connector
Indication:	Yellow USB LED status
Reset button:	settings to their default values
Power supply:	230 VAC / 12 V DC supplied with the data logger

Operating conditions

Operating temperature:	-20 .. +55 °C
Storage temperature:	-25 .. +70 °C
Protection degree:	IP30
Pollution degree:	2
Operation position:	arbitrary
Installation:	free
Design:	design box

Dimensions and weight

Dimensions:	90 x 52 x 65 mm
Weight:	136 g

- The applications iHC-MAIR and iHC-MIIR provide universal control for all Audio/Video devices (including air conditioning).
- The application is connected via smart phone connected to the smart IR box eLAN-IR-003, which communicates with Audio/Video devices via IR sensor.
- The intuitive application environment makes it simple for anyone to control.
- What all can you control? home theater, TV, DVD or Blue Ray player, amplifier, set-top box, satellite receiver, air-conditioning, projector and more...
- It can control up to 100 arbitrary commands with various controllers that you normally have at home.
- The scenes function, where, you perform multiple functions simultaneously by a single command (e.g. you are going to bed you and switch off all AV appliances in the entire home with a single press).
- It is possible to integrate into a single application an unlimited number of IR boxes, meaning that in one application, you have control over the living room, children's rooms, etc.
- It is also possible to control remotely from anywhere using a Wi-Fi network (e.g. from work or vacation).
- Thanks to auto-IP acquisition from the DHCP server, you need not set up a network (if you have no set fixed IP address).
- You can connect three sensors to the smart IR box eLAN-IR-003 for three directions of control.

Example of connection

The front panel

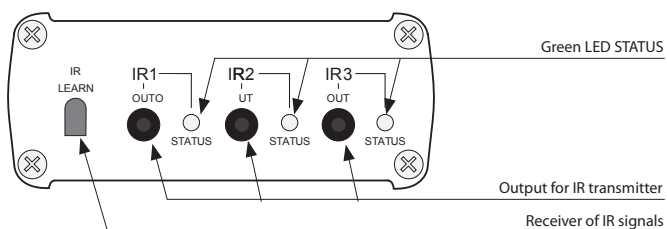

The back panel

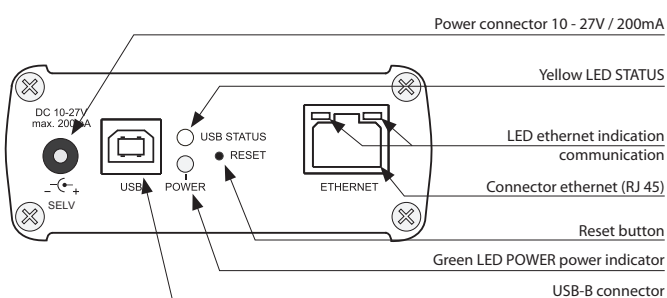

Controller options menu in the application

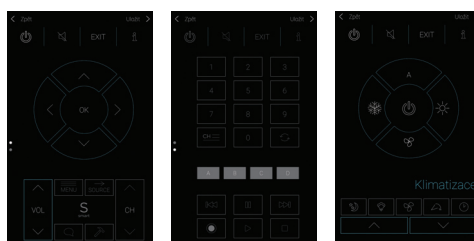



EAN code
eLAN-RS485/232: 8595188170260

Technical parameters		eLAN-RS485/232
Interface Ethernet		
ETH operating status indicator:		green LED
ETH communication indicator:		yellow LED
Communications interface:		100 Mbps (RJ45)
IP address support:		static, DHCP client
Factory setting:		DHCP client
Interface RS485		
Broadcast indication:		red LED
Connector:		PUSH IN max 1.5 mm ²
Bus termination on the eLAN-RS side:		120 Ω resistor (implemented inside the eLAN-RS485/232)
Range:		up to 1 km (depending on cable used and communication speed)
Communication speed:		adjustable, max. 230.4 Kbps
Max. connection:		32 devices
Communication:		half-duplex transmission
Type of communication:		MODBUS - RTU, EZS Jablotron, Air Pohoda
Parity setting:		none, odd, even
Length:		5 / 6 / 7 / 8 bit
Stop bit:		1/2
Interface RS232		
Broadcast indication:		red LED
Connector:		PUSH IN max 1.5 mm ²
Bus termination on the eLAN-RS side:		120 Ω resistor (implemented inside the eLAN-RS485/232)
Communication speed:		adjustable, max. 230.4 Kbps
Max. connection:		32 devices
Communication:		half-duplex transmission
Type of communication:		MODBUS - RTU, EZS Jablotron, Air Pohoda
Parity setting:		none, odd, even
Length:		5 / 6 / 7 / 8 bit
Stop bit:		1/2
Power supply		
Indication:		Yellow LED STATUS
Supply voltage/current:		10-27 V DC / 200 mA SELV
Power:		adapter with connector Jack Ø 2.1 mm (part of supply) Passive PoE or connector USB-B
Supply voltage indication:		Green LED POWER
Button RESET:		To factory settings
Power source:		230 V AC / 12 V DC supplied with the data logger
Operating conditions		
Operating temperature:		-20 .. +55 °C
Storage temperature:		-25 .. +70 °C
Protection degree:		IP 20
Pollution degree:		2
Operation position:		arbitrary
Installation:		free
Design:		design box
Dimensions and weight		
Dimensions:		90 x 52 x 65 mm
Weight:		110 g

- The eLAN-RS485/232 is used to communicate with devices communicating via the Modbus RTU protocol, with the converter acting as a master unit.
- eLAN-RS485/232 is equipped with a web interface to configure the connected devices.
- Thanks to the web interface, the eLAN-RS485 / 232 can be used as a stand-alone device.
- eLAN-RS485/232 is integrated into the Connection Server, which makes it possible to control the connected technology through iNELS Home Control (iHC). Thus, it is possible to control, for example, ventilation systems and heat recovery from NILAN.
- The eLAN-RS485/232 is equipped with A, B and GND terminals for connection to the RS485 serial line on the back panel, as well as a signalling diode to indicate the reception status.
- The front panel features an RJ45 connector to connect to the Ethernet via a network cable.
- The power supply of the eLAN-RS485/232 is possible via a 10-27V DC adapter (adapter included) or through a 24V DC PoE, e.g. directly from a switch or PoE injector.
- The eLAN-RS485/232 requires the RS485 serial interface to be connected in line and to comply with all policy and installation requirements of this interface.

Example of connection

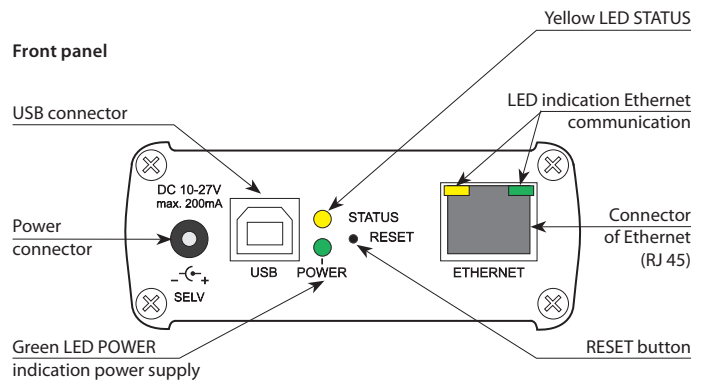

Back panel

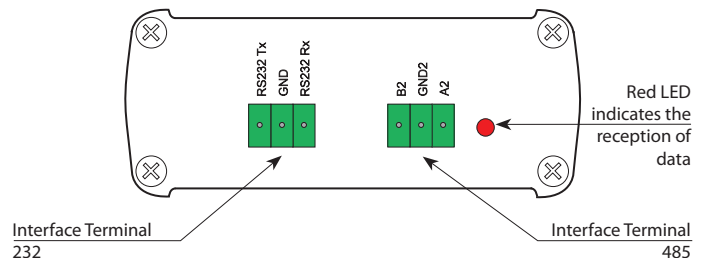



Radio



Music

Video-
telephone

Intercom



Audiozone



- A music and Internet radio player - all in the dimension of a switch and a luxurious LOGUS⁹⁰ design.
- LARA Radio - when connected to the Internet, it can play streaming radio stations and you can store up to 40 of them. But you can also select from thousands of radio stations from across the globe, which provide data for correct connection.
- LARA Radio can play content from an external music source, which can be a smart phone or e.g. an MP3 player. These devices are connected to a 3.5mm stereo jack audio input, located underneath the front panel.
- LARA Radio can also play audio files from central data storage, onto which Logitech Media Server is installed. This LARA function can therefore be used within the complex iNELS system or as an entirely independent home automation device. When used within iNELS, control is a part of the complex application iHC. If using with NAS data storage, the application LARA NAS App is available.
- Touch control is performed on the device front panel (six capacity buttons available), or LARA Dio.
- The basic device settings (network connection, language, audio input) are performed via the display and a simple menu controlled from capacity buttons on the device front cover. Further settings (selection of stations, connection with the server, updating firmware, etc.) are configured via computer and the software LARA Configurator.
- LARA Radio is equipped with an OLED colored display with the size of 1.5". The display also shows basic information about playing music, which also serves the orientation in the menu settings, etc.
- LARA Radio has an integrated amplifier with 2x 10 W output, thus greatly facilitating device installation in places where such output suffices. LARA is used e.g. to provide premium sound to the kitchen, bathrooms, waiting rooms, offices, reception desks, entrance halls, operating rooms or wellness facilities.
- LARA is powered by PoE with maximum voltage level 27 V DC / 1000 mA. So connecting and communicating with just one cable (UTP) is a major advantage.
- For LARA, an entire series of accessories is ready for connection (PoE adapters, PoE switches), speakers (in a frame, walls or ceilings) and installation (cables, box, etc.).
- Complies with standards IEEE 802.3u (100BASE-Tx).
- Automatic cable crossing detection of Ethernet cable - MDIX.

Technical parameters

LARA Radio

Internet Radio

Supported data transfer formats:	mp3, ogg, acc
----------------------------------	---------------

Control / Settings

Front panel:	touchscreen buttons
Communication Ethernet:	via PC setting up and communicating SW LARA Configurator
Button RESET:	restart product / reset product to factory settings

Interface ethernet

Communications interface:	10/100 Mbps
Connector:	RJ45
Max. cable length UTP with power:	50 m

Display

Type:	color OLED
Resolution:	128 x 128 pixels
Visible surface:	26 x 26 mm

Power supply

Supply:	POE 24 V DC/1.25 A
Min. input:	1.4 W
Max. input:	26 W (peak at maximum playback performance)

Amplifier

Amplifier:	stereophonic class D with digital output control
Max. amplifier output:	2 x10 W/8 Ω

Inputs / Outputs

Microphone:	NO
Audio input:	3.5 stereo jack
Audio output 1:	terminals LINE OUT (used for external amplifier)*
Audio output 2:	terminals OUT L/OUT R (speaker output from int. amplifier)

Connection

Terminal block:	0.5 - 1 mm ²
-----------------	-------------------------

Other data

Working temperature:	0 .. + 55 °C
Protection degree:	IP20
Overvoltage category:	II.
Pollution degree:	2
Installation:	in an installation box

Dimensions and weight

Dimensions:	
- plastic:	85 x 85 x 46 mm
- metal, glass, wood, granite:	94 x 94 x 46 mm
Weight:	209 g (plastic frame)

* The cable from the LINE OUT terminals must be shielded, max. length should not exceed 5 m.

EAN code

LARA Radio white:	8595188148719
LARA Radio ivory:	8595188149242
LARA Radio ice:	8595188149228
LARA Radio pearl:	8595188149259
LARA Radio aluminium:	8595188149211
LARA Radio grey:	8595188149235

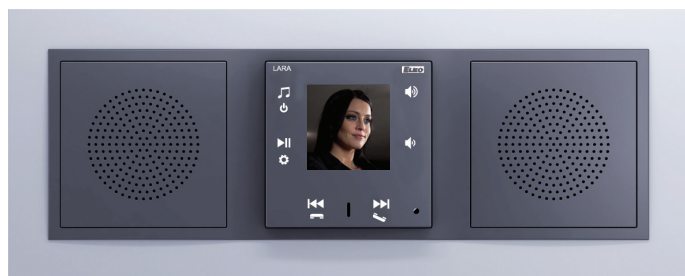
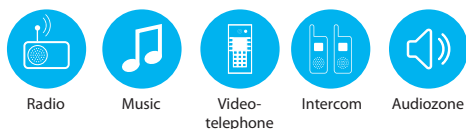

Technical parameters		LARA Intercom
Internet Radio		
Supported data transfer formats:	mp3, ogg, acc	
Control / Settings		
Front panel:	touchscreen buttons	
Communication Ethernet:	via PC setting up and communicating SW LARA Configurator	
Button RESET:	restart product / reset product to factory settings	
Interface ethernet		
Communications interface:	10/100 Mbps	
Connector:	RJ45	
Max. cable length UTP with power:	50 m	
Display		
Type:	color OLED	
Resolution:	128 x 128 pixels	
Visible surface:	26 x 26 mm	
Power supply		
Supply:	POE 24 V DC/1.25 A	
Min. input:	1.4 W	
Max. input:	26 W (peak at maximum playback performance)	
Amplifier		
Amplifier:	stereophonic class D with digital output control	
Max. amplifier output:	2 x10 W/8 Ω	
Inputs / Outputs		
Microphone:	YES	
Audio input:	3.5 stereo jack	
Audio output 1:	terminals LINE OUT (used for external amplifier)*	
Audio output 2:	terminals OUT L/OUT R (speaker output from int. amplifier)	
Connection		
Terminal block:	0,5 - 1 mm ²	
Other data		
Working temperature:	0 .. + 55 °C	
Protection degree:	IP20	
Overvoltage category:	II.	
Pollution degree:	2	
Installation:	in an installation box	
Dimensions and weight		
Dimensions:		
- plastic:	85 x 85 x 46 mm	
- metal, glass, wood, granite:	94 x 94 x 46 mm	
Weight:	209 g (plastic frame)	

* The cable from the LINE OUT terminals must be shielded, max. length should not exceed 5 m.

- LARA Intercom offers users 5 different functions and expands even more options to Lara Radio - music players and internet radio stations within the range of LOGUS⁹⁰ switch designs.
- LARA Intercom provides an extra functionality and videophone intercom.
- Thanks to videophone function, now it is possible to have a voice communication between LARA and the sound of the door (IP Intercom), so with someone visiting and standing in front of the house, we can see that on LARA display as part of this function which increases the security feeling and safety besides of course, the comfort for the user.
- LARA Intercom is equipped with an OLED colored display with the size of 1.5", which is used to transfer images and sounds from the door camera properly. The display also shows basic information about playing music, which also serves the orientation in the menu settings, etc.
- The intercom function can also be used for communications between all the family members throughout the whole house, thanks to two way voice communications possibilities between different LARA units.
- LARA Intercom continues to offer three functions that are also supported by LARA Radio - when connected to the Internet, it can play streaming radio stations and you can store up to 40 of them. But you can also select from thousands of radio stations from across the globe, which provide data for correct connection.
- LARA Intercom can play content from an external music source, which can be an smart phone or e.g. an MP3 player. These devices are connected to a 3.5mm stereo jack audio input, located underneath the front panel.
- LARA Intercom can also play audio files from central data storage, onto which Logitech Media Server is installed. This LARA function can therefore be used within the complex iNELS system or as an entirely independent home automation device. When used within iNELS, control is a part of the complex application iHC. If using with NAS data storage, the application LARA NAS App is available.
- Touch control is performed on the device front panel (six capacity buttons available), or LARA Dio.
- The basic device settings (network connection, language, audio input) are performed via the display and a simple menu controlled from capacity buttons on the device front cover. Further settings (selection of stations, connection with the server, updating firmware, etc.) are configured via computer and the software LARA Configurator.
- LARA Intercom has an integrated amplifier with 2x 10 W output, thus greatly facilitating device installation in places where such output suffices. LARA is used e.g. to provide premium sound to the kitchen, bathrooms, waiting rooms, offices, reception desks, entrance halls, operating rooms or wellness facilities.
- LARA is powered by PoE with maximum voltage level 27 V DC / 1000 mA. So connecting and communicating with just one cable (UTP) is a major advantage.
- For LARA, an entire series of accessories is ready for connection (PoE adapters, PoE switches), speakers (in a frame, walls or ceilings) and installation (cables, box, etc.).
- Complies with standards IEEE 802.3u (100BASE-Tx).
- Automatic cable crossing detection of Ethernet cable - MDIX.

EAN code

LARA Intercom white:	8595188149389
LARA Intercom ivory:	8595188149419
LARA Intercom ice:	8595188149396
LARA Intercom pearl:	8595188149426
LARA Intercom aluminium:	8595188149372
LARA Intercom grey:	8595188149402

Touchscreen operation

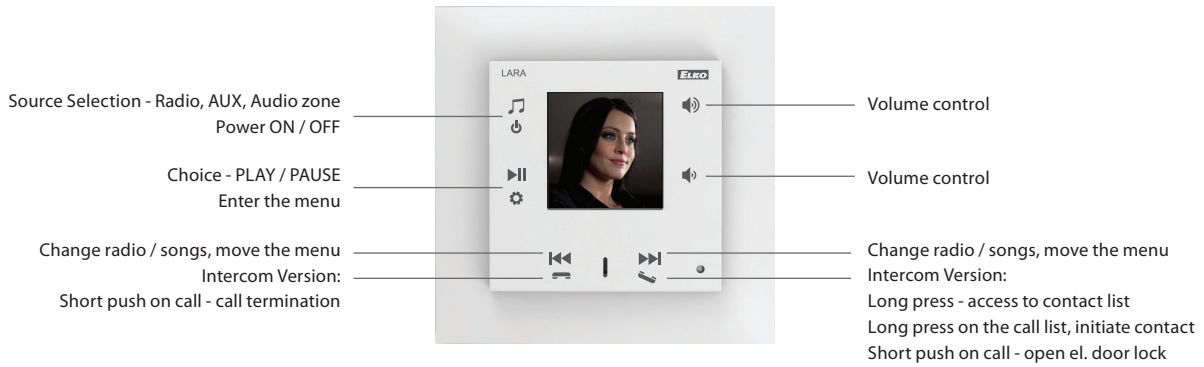

Applications control

Operations, using the application for, LARA Dio and iNELS Home Control for Android and iOS smartphones and tablets.



Wiring example

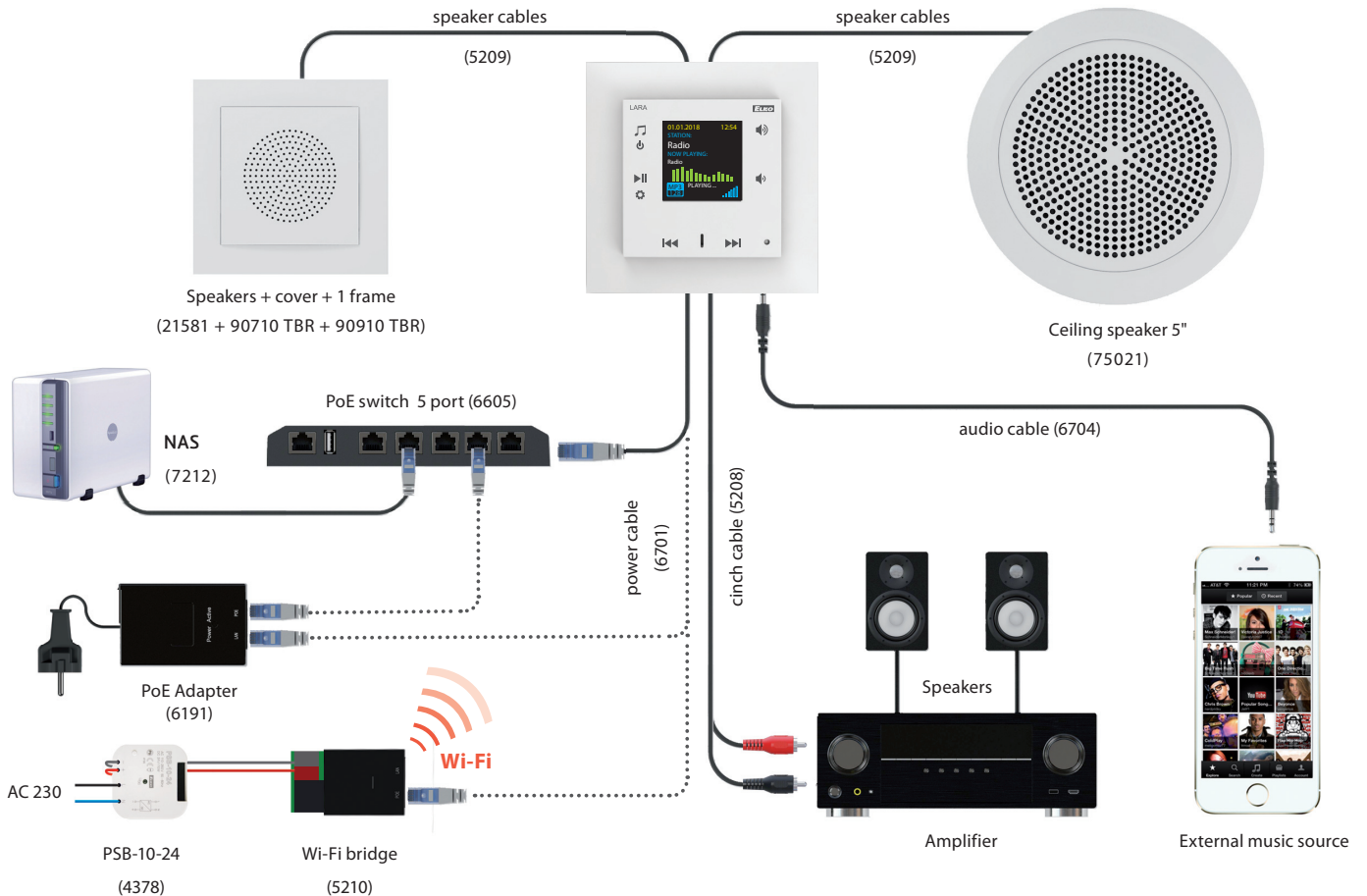

Speakers and cables

	AUX CABLE LARA (LARA CINCH CABLE) Used to connect LARA with exter. amplifier. Reduction 4pin from LARA LINE OUT to 2x CINCH plug into amplifier, length 2 x 20 cm.	5208
	POWER SUPPLY (PSB-10-24) Switching stabilized power supplies with fixed output voltage, intended for mounting into an installation box (e.g. KU-68). PSB-10-24 - stabilized power supply 24V/10 W.	4378
	AUX CABLE LARA (LARA AUDIO CABLE) Used to connect LARA with external music source (smart phone mp3 player). The length is 20cm terminated with 2x stereo jack 3.5mm.	6704
	CEILING SPEAKER Speaker is suitable for the installation in suspended ceilings and hollow walls. Mounting hole diameter 143 mm, Power 8W, 32Ω speaker impedance.	75021 CBR
	SURFACE SPEAKER Two-way speaker intended for mounting in a ceiling or on the walls: Power 15W, 32 Ω speaker impedance, dimensions 270x183x37 mm. Color: White	75106 CBR
	NAS EXTERNAL STORAGE Two-chamber NAS server with the function of hosting, sharing and data security.	7212
	NETWORK CABLE, 0.2 m Flat white LAN cable CAT5, length 20 cm, terminated with 2x RJ45 plugs.	6702
	NETWORK CABLE, 1 m Flat white LAN cable CAT5, length 1 m, terminated with 2x RJ45 plugs.	6700

Power supply and network

	WI-FI BRIDGE Used for LARA wireless connection via WiFi network.	5210
	PoE SWITCH - 5x RJ45 Provides LAN connectivity and PoE power supply for up to 5 x LARA.	6605
	PoE SWITCH - 8x RJ45 Provides LAN and connected PoE of up to 8x LARA. In addition to the 24V PoE also offers a 48V PoE for the power supply of 2N.	6606

Power sets

	POWER SUPPLY PoE + WiFi INTO OR THE BOX WiFi bridge with PoE and power supply into an installation box. Power supply 230V.	5224
	POWER SUPPLY PoE INTO A BOX PoE injector with power supply intended for an installation box. Power supply 230 V.	5226
	PoE SUPPLY Power injector with plug-in adapter 230V.	5225
	POWER SUPPLY PoE + WiFi WiFi bridge with PoE plug in adapter 230 V.	5227

Installation material

	1-FRAME	90910 TBR
	2-FRAME	90920 TBR
	3-FRAME	90930 TBR
	4-FRAME	90940 TBR
	5-FRAME	90950 TBR
	SURFACE MOUNT BOX	10976 ABR
	INSTALLATION BOX 1 GANG (KP 67/2)	6705
	INSTALLATION BOX 2 GANG (KP 64/2)	6706
	INSTALLATION BOX 3 GANG (KP 64/3)	6707
	INSTALLATION BOX 4 GANG (KP 64/4)	6708
	INSTALLATION BOX 5 GANG (KP 64/5)	6709
	INSTALLATION BOX 1 GANG (KP 64/LD)	6710
	INSTALLATION BOX 2 GANG (KP 64/2L)	6711
	INSTALLATION BOX 3 GANG (KP 64/3L)	6712
	INSTALLATION BOX 4 GANG (KP 64/4L)	6713
	INSTALLATION BOX 5 GANG (KP 64/5L)	6714
	UNIVERSAL BOX 1068-02	6716
	UNIVERSAL BOX KUH 1/L NA	6717

2N Helios IP Verso



2N Helios IP Base



Applications for system control for your tablet or smartphone

Development of smartphones and tablets and development of applications for these devices go together. You can control your electro-installation through the applications in your iPhone, iPad, Smartphone or tablet with the Android operating system. As opposed to our competitors, we provide you a solution assuring you that your household appliances can be controlled through just one application. You will find here whatever you need – it provides you full managing, monitoring and checking of your house. You can control not only lighting or heating, but also it enables you to switch the TV programs, play music and control air conditioning. iHC is an acronym of iNELS Home Control and letters after the hyphen means devices (T= tablet, M = mobile / smartphone) and operating system (Android = A, I = iOS / Apple).

They are FREE for download at the AppStore and GooglePlay (Play Store).

You can also try out our PROMO application, in which in real time, you control our showrooms in Prague, Nitra or Holešov.

iHC-MI
/ iHC-TI



iHC-MI
PROMO



iHC-MA
/ iHC-TA



iHC-MA
PROMO



 iHC-MI



 iHC-MA



 iHC-TI



 iHC-TA



APPS FOR ALL... iNELS Home Control



iNELS BUS System (bus electro installation)					iNELS RF Control (wireless electro installation)			
Android		iOS		TIZEN [®]	Android	iOS	TIZEN [®]	SAMSUNG Gear S2/S3
iHC-TA	iHC-MA	iHC-TI	iHC-MI	iSHC	iHC-MAIRF	iHC-MIIRF	iSHC	iHC-WTRF

		iHC-TA	iHC-MA	iHC-TI	iHC-MI	iSHC	iHC-MAIRF	iHC-MIIRF	iSHC	iHC-WTRF
BUS & RF	Lighting	✓	✓	✓	✓	✓	✓	✓	✓	✓
	Blinds	✓	✓	✓	✓	✓	✓	✓	✓	✓
	Socket	✓	✓	✓	✓	✓	✓	✓	✓	✓
	Garage doors, gates	✓	✓	✓	✓	✓	✓	✓	✓	✓
	RGB bulbs, LED strips	✓	✓	✓	✓	✓	✓	✓	✓	✓
	Scenes	✓	✓	✓	✓	✓	✓	✓	✓	✓
	Heating	✓	✓	✓	✓	✓	✓	✓	✓	✓
Third Parties Integration	Cameras	✓	✓	✓	✓	✓	✓	✓	✓	✗
	Air-conditioning	✓	✓	✓	✓	✓	✓	✓	✗	✗
	Recuperation	✓	✓	✓	✓	✓	✗	✗	✗	✗
	Home appliances (MIELE)	✓	✓	✓	✓	✓	✗	✗	✗	✗
	Weather station	✓	✓	✓	✓	✓	✓	✓	✗	✗
	Measurement and visualization of energy	✓	✓	✓	✓	✓	✓	✓	✓	✗
	Door communicator and Intercom	✓	✓	✓	✓	✓	✓	✓	✓	✗
	A/V appliances	✓	✓	✓	✓	✓	✓	✓	✗	✗

✓ Supported ✗ Not supported

iNELS Home Control applications are FREE to download at or and are supported by Android OS 4.2 or later and iOS8 or later.



EAN code
 TELVA 230V, NC: 8595188166010
 TELVA 230V, NO: 8595188166027
 TELVA 24V, NC: 8595188166034
 TELVA 24V, NO: 8595188166041

Technical parameters	TELVA 230V	TELVA 24V
Operating voltage:	230V, 50/60 Hz	24V, 50/60 Hz
Switching current max:	300 mA for max. 2 min	250 mA on max. 2 min
Operating current:	8 mA	75 mA
Closing / opening time:	dtto 3 min.	dtto 3 min.
Power input:	1.8 W	1.8 W
Protection:	IP 54/II	IP 54/II
Settings:	4 mm	4 mm
Stopping force:	100 N ±5 %	100 N ±5 %
Cable length:	1 m	1 m
Connecting wire:	2 x 0.75 mm ²	2 x 0.75 mm ²
Media temperature:	0 to +100 °C	0 to +100 °C
Color:	white RAL 9003	white RAL 9003
Dimensions h/w/d:	55+5 x 44 x 61 mm	55+5 x 44 x 61 mm

- The thermo-regulation drive TELVA is used to control underfloor and radiator hot-water heating.
- It is known for its quiet operation. It has a built-in valve position indicator.
- By mounting using the VA valve adapter, the thermo-regulation drive TELVA is applicable for a wide range of thermostatic valves available on the market.
- Design:
 - without voltage open (NO)
 - without voltage closed (NC)
- Types:
 - TELVA 230V, NO
 - TELVA 230V, NC
 - TELVA 24V, NO
 - TELVA 24V, NC
- Type of use:
 - Switching units of the series SA3 are used within the BUS system iNELS BUS to control TELVA thermodrives.

It is generally supplied with a valve adapter VA-80 in low design with bar M30 x 1.5 (white-gray), which may not be compatible with all types of valves.

AN-I | Internal antenna



- into plastic switchboard
- rod angle, without cable
- sensitivity 1 dB
- the internal antenna is included in the standard package

EAN code
 Internal antenna AN-I: 8595188161862

AN-E | External antenna



- for mounting into metal switchboard
- cable length 3m
- sensitivity 5 dB
- the external antenna AN-E is supplied on request only

EAN code
 External antenna AN-E: 8595188190121



EAN code			
TC-0:	8595188110075	TZ-0:	8595188140591
TC-3:	8595188110617	TZ-3:	8595188110600
TC-6:	8595188110082	TZ-6:	8595188110594
TC-12:	8595188110099	TZ-12:	8595188110587
Pt100-3:	8595188136136	Pt100-6:	8595188136143
Pt100-12:	8595188136150		

Technical parameters	TC	TZ	Pt100
Range:	0 °C to +70 °C	-40 °C to +125 °C	-30 °C to +200 °C
Scanning element:	NTC 12K 5 %	NTC 12K 5 %	Pt100
In air/ in water:	(τ65) 92 s / 23 s	(τ65) 62 s / 8 s	(τ0.5) - / 7 s
In air/ in water:	(τ95) 306 s / 56 s	(τ95) 216 s / 23 s	(τ0.9) - / 19 s
Cable material:	High temperature PVC	Silicone	Silicone
Terminal material:	High temperature PVC	Nickel plated copper	Copper
Protection degree:	IP 67	IP 67	IP 67
Insulation:	-	-	double insulation silicone

Types of temperature sensors:

	TC-0	TZ-0	-
- length:	100 mm	110 mm	-
- weight:	5 g	4.5 g	-
	TC-3	TZ-3	Pt100-3
- length:	3 m	3	3 m
- weight:	108 g	106 g	68 g
	TC-6	TZ-6	Pt100-6
- length:	6 m	6 m	6 m
- weight:	213 g	216 g	149 g
	TC-12	TZ-12	Pt100-12
- length:	12 m	12 m	12 m
- weight:	466 g	418 g	249 g

τ65 (95): time, which sensor needs to heat up on 65 (95) % of ambient temperature of environment, in which is located.

- Thermister temperature sensors are made of Negative Temperature Coefficient (NTC) embedded in a PVC or metal sleeve with a thermally-conductive sealer.
- Sensor TC**
 - lead-in cable to sensor TC is made of wire CYSY 2D x 0.5 mm/ 0.02".
- Sensor TZ**
 - cable VO3SS-F 2D x 0.5 mm /0.02" with silicone insulation for use in high temperature applications.
 - silicone insulation for use in high temperature applications.
- Sensor Pt100**
 - shielded silicon 2x 0.22 mm² (AWG 21), shielding connected with a case.
- temperature sensors can be connected directly to the terminal block
- cable lengths can not be changed, connected or modified.

Resistive values of sensors in dependance on temperature

Temperature (°C)	Sensor NTC (kΩ)	Sensor Pt100 (Ω)
20	14.7	107.8
30	9.8	111.7
40	6.6	115.5
50	4.6	119.4
60	3.2	123.2
70	2.3	127.1

Tolerance of sensor NTC 12 kΩ is ± 5% by 25 °C/ 77°F.
Long-term resistance stability by sensor Pt100 is 0.05% (10 000 hours).

Diagramm of sensor warm up via air

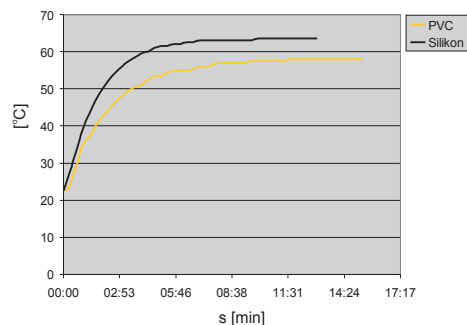

PVC -reaction to water temperature from 22.5 °C to 58°C.
Silicone - reaction to water temperature from 22.5°C to 63.5°C.

Sensor photo

TC



Drawing

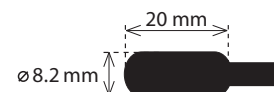

TZ

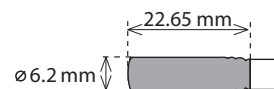

Pt100

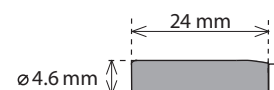



















Minimum load

Relay contact	mV	V/mA
AgSnO ₂	1000	10/100



















Minimum load

Relay contact	mV	V/mA
AgNi	300	5/10



















GCR3-11, GCH3-31, GMR3-61, SA3-02B, SA3-06M, SA3-012M, WMR3-21

Type of load	 cos φ ≥ 0.95								
Contact material	AC1	AC2	AC3	AC5a uncompensated	AC5a compensated	AC5b	AC6a	AC7b	AC12
AgSnO ₂ contact 8A	250V / 8A	250V / 2.5A	250V / 1.5A	230V / 1.5A (345VA)	230V / 1.5A (345VA) till max output C=14uF	250W	250V / 4A	250V / 1A	250V / 1A
Type of load									
Contact material	AC13	AC14	AC15	DC1	DC3	DC5	DC12	DC13	DC14
AgSnO ₂ contact 8A	x	250V / 3A	250V / 3A	24V / 8A	24V / 3A	24V / 2A	24V / 8A	24V / 1A	x



















CU3-04M (RE7 - RE-10), LBC3-02M, SA3-01B, SA3-02M, SA3-04M, SA3-022M (RE7 - RE-10), JA3-018M (U/D1 - U/D9)

Type of load	 cos φ ≥ 0.95								
Contact material	AC1	AC2	AC3	AC5a uncompensated	AC5a compensated	AC5b	AC6a	AC7b	AC12
AgSnO ₂ contact 16A	250V / 16A	250V / 5A	250V / 3A	230V / 3A (690VA)	230V / 3A (690VA) till max output C=14uF	1500W	x	250V / 3A	250V / 10A
Type of load									
Contact material	AC13	AC14	AC15	DC1	DC3	DC5	DC12	DC13	DC14
AgSnO ₂ contact 16A	250 / 6A	250V / 6A	250V / 6A	24V / 16A	24V / 6A	24V / 4A	24V / 16A	24V / 2A	24V / 2A

SA3-02B/Ni*, SA3-06M/Ni*, SA3-012M/Ni*





Type of load	 cos φ ≥ 0.95								
Contact material	AC1	AC2	AC3	AC5a uncompensated	AC5a compensated	AC5b	AC6a	AC7b	AC12
AgNi contact 8A	250V / 8A	250V / 2.5A	250V / 1.5A	230V / 1.5A (345VA)	x	400W	x	250V / 1.5A	250V / 5A
Type of load									
Contact material	AC13	AC14	AC15	DC1	DC3	DC5	DC12	DC13	DC14
AgNi contact 8A	250 / 3A	250V / 3A	250V / 3A	24V / 8A	24V / 3A	24V / 2A	24V / 8A	24V / 1A	24V / 1A

SA3-01B/Ni*, SA3-06M/Ni*, SA3-04M/Ni*

Type of load	 cos φ ≥ 0.95								
Contact material	AC1	AC2	AC3	AC5a uncompensated	AC5a compensated	AC5b	AC6a	AC7b	AC12
AgNi contact 16A	250V / 16A	250V / 5A	250V / 3A	230V / 3A (690VA)	x	800W	x	250V / 3A	250V / 10A
Type of load									
Contact material	AC13	AC14	AC15	DC1	DC3	DC5	DC12	DC13	DC14
AgNi contact 16A	250 / 6A	250V / 6A	250V / 6A	24V / 16A	24V / 6A	24V / 4A	24V / 16A	24V / 2A	24V / 2A

JA3-018M (U/D1 - U/D9)







CU3-04M (RE1 - RE6, OUT1 - OUT2, RE16 - RE11 - RE16),
SA3-022M (RE1 - RE6, OUT1 - OUT2, RE16 - RE11 - RE16),
FA3-612M (RE1 - RE4)

Type of load	 cos φ ≥ 0.95			
Contact material	AC1	AC3	AC15	DC1
AgNi contact 6A	250V / 6A	230V / 0.8A	230V / 1.3A	30V / 3A 110V / 0.2A 220V / 0.12A





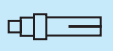







Demonstrated symbols are informative.

*Products with AgNi contact only up on request for extra charge.

Loadability of contacts

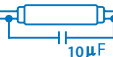
Load	bulbs, halogen bulbs	12–24V low-voltage bulbs, coil transformers	12–24V low-voltage bulbs, electric transformers	LEDs	energy-saving fluorescent tubes	control method	
							
	R	L	C	dimmable	dimmable	entering edge	trailing edge
DA3-22M	•	•	•	•	•	•	•
DA3-06M	•	•	•	•	•	•	•

Explanations

	El. bulbs loads: el. bulb, halogen light	(R)		Elektronic ballasts for fluorescent	(L)
	Dimmer with defined load: R - resistive, L - inductive, C - capacitive			Inductive loads (transformers): feromagnetic and toroid transformers for lights with various voltage.	
	Fluorescent light: fluorescent lights uncompensated			Switch: switch - control contact of various device	
	Fluorescent light: fluorescent light compensated in series			Button: control button	
	Fluorescent light: fluorescent light compensated in parallel			Control module: analog control module 0 - 10 V	
	Fluorescent light: fluorescent light economical			Motor	

Category of use	Typical use
AC current, $\cos\varphi = P/S$ (-)	
AC-1	Non-inductive or slightly inductive load, resistance furnace Includes all appliances supplied by AC current with power factor ($\cos\varphi$) ≥ 0.95 Examples of usage: resistance furnace, industrial loads
AC-2	Motors with slip-ring armature, switching off
AC-3	Motors with short-circuit armature, motor switching when in operation This category applies to switching off motors with short-circuit armature while in operation. While switching, contactor switches current which is 5 up to 7 times rated current of motor.
AC-5a	Switching of electrical gas-filled lights, fluorescent lights
AC-5b	El. bulb switching Enables low contact loading due to resistance of cold fiber is many times smaller than the one of hot fiber.
AC-6a	Switching of transformers
AC-7b	Load of motors for home appliances
AC-12	Switching of semiconductor loads with separation transformers
AC-13	Switching of semiconductor loads with separation transformers
AC-14	Switching of low electro-magnetic loads (max.72 VA)
AC-15	Management of alternating electro-magnetic loads This category applies to switching inductive loads with input for closed electro-magnetic circuit higher than 72 VA Use: switching coils of contactors

Note: Category AC 15 replaces formerly used category AC 11

DC current, $t = L/R$ (s)

DC-1	Non-inductive or low inductive load, resistive furnaces
DC-3	Shunt motors: start-up, braking by backset, reversion, resistive braking
DC-5	Series motor: start-up, braking by backset, reversion, resistive braking
DC-12	Management of resistive loads and fixed loads with insulation by opto-electric element
DC-13	Switching of electromagnets
DC-14	Switching of electromagnetic loads in circuits with limiting resistor

1



1) Surface mounted

Wall mounted in an installation box with spacing of 65 mm.

EST3	GSB3-40	WMR3-21
EHT3	GSB3-60	WSB3-20
GBP3-60	GSB3-80	WSB3-20H
GCR3-11	GSP3-100	WSB3-40
GCH3-31	GMR3-61	WSB3-40H
GRT3-50	IDRT3-1	

2

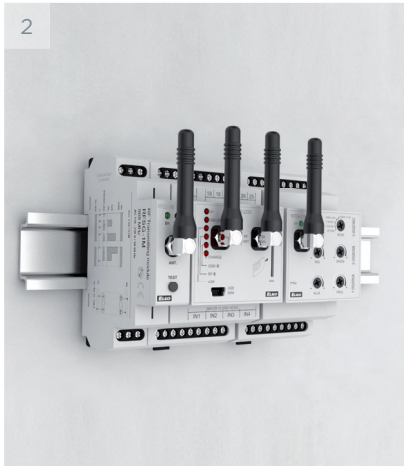

2) DIN Rail mounted

On DIN rail according to EN 60715.

ADC3-60M	DAC3-04M	MI3-02M
BPS3-01M	DCDA-33M	MI3-02M/EHT
BPS3-02M	EA3-022M	PS3-100/iNELS
CU3-01M	EMDC-64M	SA3-02M
CU3-02M	FA3-612M	SA3-04M
CU3-03M	GSM3-01M	SA3-06M
CU3-04M	IM3-140M	SA3-012M
DA3-06M	JA3-09M	SA3-022M
DA3-22M	LBC3-02M	TI3-60M

3

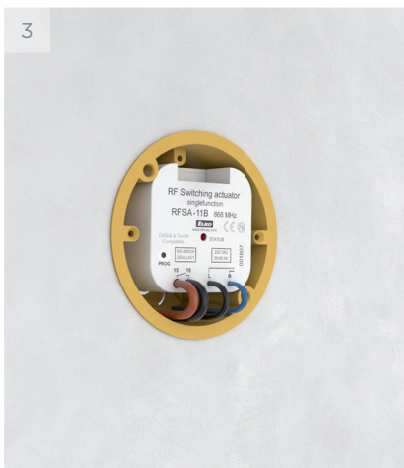

4) Mounted to or in the installation box

Mounted in an installation box or built into the device.

DAC3-04B	IM3-80B	SA3-02B
IM3-20B	JA3-02B/DC	TI3-10B
IM3-40B	SA3-01B	TI3-40B

4



4) Mounted into the cover of appliance

SA3-01B
SA3-02B



5) Surface mounted

Other attachment options.

DLS3-1
iTP 10"



6) Ceiling mounting

DMD3-1

1-MODUL

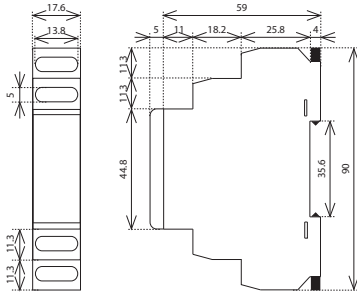

BPS3-01M
BPS3-02M
MI3-02M
SA3-02M

3-MODUL

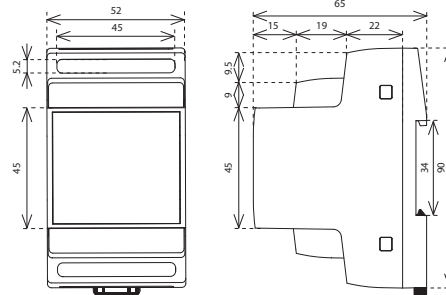

ADC3-60M
DA3-06M
DA3-22M
DAC3-04M
DCDA-33M
EMDC-64M
GSM3-01M

IM3-140M
LBC3-02M
SA3-04M
SA3-06M
TI3-60M

6-MODUL

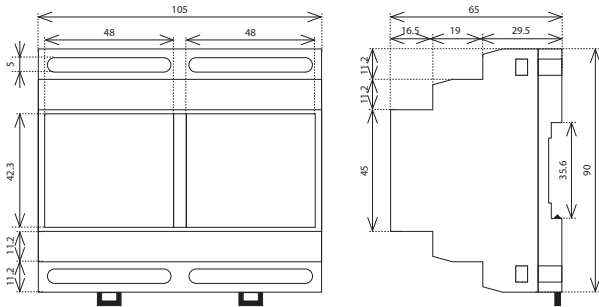

CU3-01M
CU3-02M
CU3-03M
CU3-04M
EA3-022M
FA3-612M

JA3-09M
PS3-100/iNELS
SA3-012M
SA3-022M

MINI

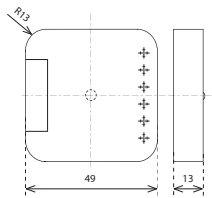

IM3-20B
IM3-40B
JA3-02B/DC

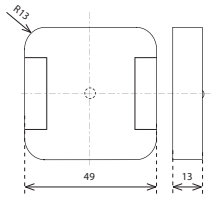

DAC3-04B
IM3-80B
TI3-10B
TI3-40B

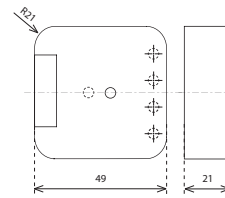

SA3-01B
SA3-02B

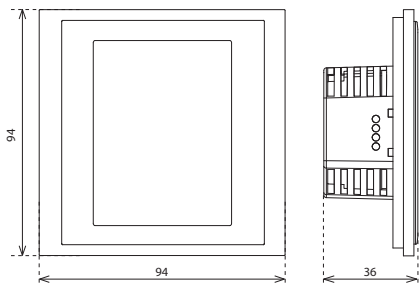

EST3-1
EHT3-1

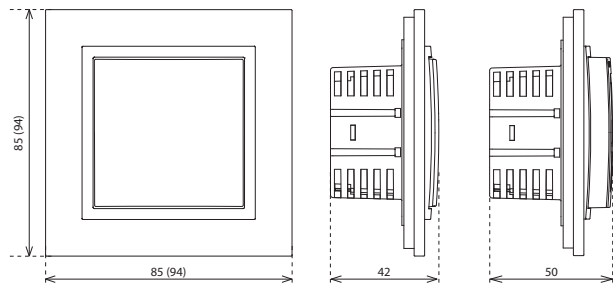

WSB3-20
WSB3-20H
WSB3-40
WSB3-40H
WMR3-21

IDRT3-1

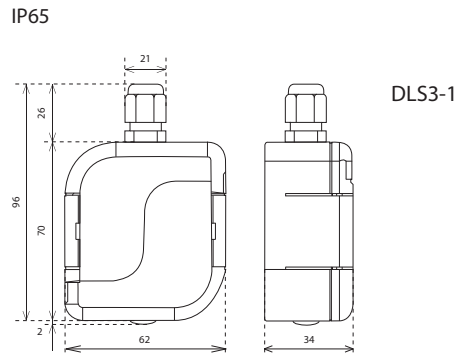
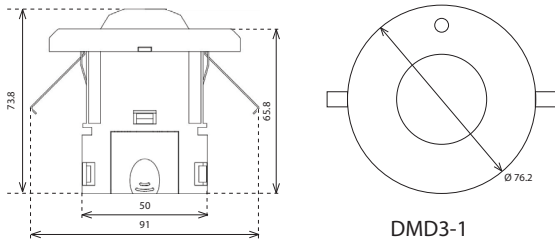
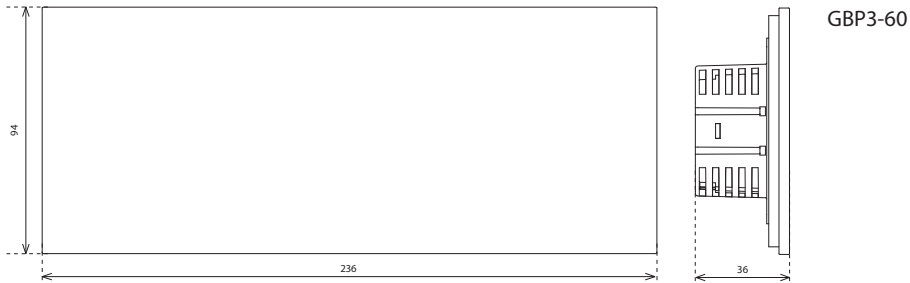
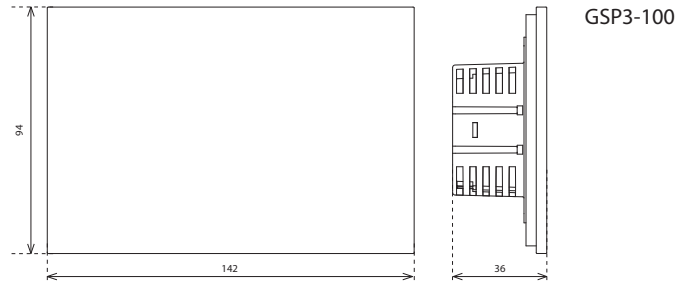
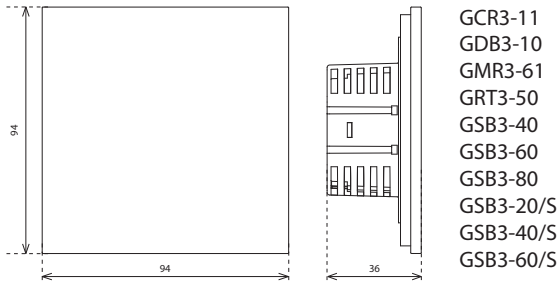

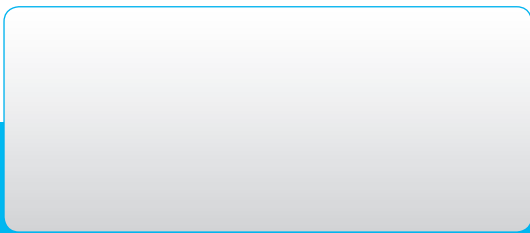

ELKO EP, s.r.o.

Palackeho 493 | 769 01 Holesov, Vsetuly | Czech Republic

phone: +420 573 514 221 | fax: +420 573 514 227 | elko@elkoep.com | www.elkoep.com

Published: 01/2019 | Modifications or amendments reserved | © Copyright ELKO EP, s.r.o. | 1st edition